

About this Manual

We've added this manual to the Agilent website in an effort to help you support your product. This manual is the best copy we could find; it may be incomplete or contain dated information. If we find a more recent copy in the future, we will add it to the Agilent website.

Support for Your Product

Agilent no longer sells or supports this product. Our service centers may be able to perform calibration if no repair parts are needed, but no other support from Agilent is available. You will find any other available product information on the Agilent Test & Measurement website, www.tm.agilent.com.

HP References in this Manual

This manual may contain references to HP or Hewlett-Packard. Please note that Hewlett-Packard's former test and measurement, semiconductor products and chemical analysis businesses are now part of Agilent Technologies. We have made no changes to this manual copy. In other documentation, to reduce potential confusion, the only change to product numbers and names has been in the company name prefix: where a product number/name was HP XXXX the current name/number is now Agilent XXXX. For example, model number HP8648A is now model number Agilent 8648A.

Programmer's Guide

EMI Receiver Series

HP 8542E/HP 8546A EMI Receiver
HP 85422E/HP 85462A Receiver RF Section



HP Part No. 5962-5083
Printed in USA August 1994

Notice.

The information contained in this document is subject to change without notice.

Hewlett-Packard makes no warranty of any kind with regard to this material, including but not limited to, the implied warranties of merchantability and fitness for a particular purpose. Hewlett-Packard shall not be liable for errors contained herein or for incidental or consequential damages in connection with the furnishing, performance, or use of this material.

© Copyright Hewlett-Packard Company 1994

All Rights Reserved. Reproduction, adaptation, or translation without prior written permission is prohibited, except as allowed under the copyright laws.

1400 Fountaingrove Parkway, Santa Rosa CA, 95403-1799, USA

Certification

Hewlett-Packard Company certifies that this product met its published specifications at the time of shipment from the factory. Hewlett-Packard further certifies that its calibration measurements are traceable to the United States National Institute of Standards and Technology, to the extent allowed by the Institute's calibration facility, and to the calibration facilities of other International Standards Organization members.

Regulatory Information

Regulatory information is located in the *EMI Receiver Series Reference* at the end of Chapter 1, "Specifications and Characteristics."

Warranty

This Hewlett-Packard instrument product is warranted against defects in material and workmanship for a period of one year from date of shipment. During the warranty period, Hewlett-Packard Company will, at its option, either repair or replace products which prove to be defective.

For warranty service or repair, this product must be returned to a service facility designated by Hewlett-Packard. Buyer shall prepay shipping charges to Hewlett-Packard and Hewlett-Packard shall pay shipping charges to return the product to Buyer. However, Buyer shall pay all shipping charges, duties, and taxes for products returned to Hewlett-Packard from another country.

Hewlett-Packard warrants that its software and firmware designated by Hewlett-Packard for use with an instrument will execute its programming instructions when properly installed on that instrument. Hewlett-Packard does not warrant that the operation of the instrument, or software, or firmware will be uninterrupted or error-free.

LIMITATION OF WARRANTY

The foregoing warranty shall not apply to defects resulting from improper or inadequate maintenance by Buyer, Buyer-supplied software or interfacing, unauthorized modification or misuse, operation outside of the environmental specifications for the product, or improper site preparation or maintenance.

NO OTHER WARRANTY IS EXPRESSED OR IMPLIED. HEWLETT-PACKARD SPECIFICALLY DISCLAIMS THE IMPLIED WARRANTIES OF MERCHANTABILITY AND FITNESS FOR A PARTICULAR PURPOSE.

EXCLUSIVE REMEDIES

THE REMEDIES PROVIDED HEREIN ARE BUYER'S SOLE AND EXCLUSIVE REMEDIES. HEWLETT-PACKARD SHALL NOT BE LIABLE FOR ANY DIRECT, INDIRECT, SPECIAL, INCIDENTAL, OR CONSEQUENTIAL DAMAGES, WHETHER BASED ON CONTRACT, TORT, OR ANY OTHER LEGAL THEORY.

Assistance

Product maintenance agreements and other customer assistance agreements are available for Hewlett-Packard products. For any assistance, contact your nearest Hewlett-Packard Sales and Service Office.

Compliance

This instrument has been designed and tested in accordance with IEC Publication 348, Safety Requirements for Electronic Measuring Apparatus, and has been supplied in a safe condition. The instruction documentation contains information and warnings which must be followed by the user to ensure safe operation and to maintain the instrument in a safe condition.

Safety Notes

The following safety notes are used throughout this manual. Familiarize yourself with each of the notes and its meaning before operating this instrument.

WARNING **Warning denotes a hazard. It calls attention to a procedure which, if not correctly performed or adhered to, could result in injury or loss of life. Do *not* proceed beyond a warning note until the indicated conditions are fully understood and met.**

CAUTION Caution denotes a hazard. It calls attention to a procedure that, if not correctly performed or adhered to, would result in damage to or destruction of the instrument. Do *not* proceed beyond a caution sign until the indicated conditions are fully understood and met.

General Safety Considerations

- WARNING**
- No operator serviceable parts inside. Refer servicing to qualified personnel. To prevent electrical shock, do not remove covers.
 - If this instrument is used in a manner not specified by Hewlett-Packard Company, the protection provided by the instrument may be impaired.
 - For continued protection against fire hazard, replace line fuse only with same type and rating ([F 5A/250V]). The use of other fuses or material is prohibited.
-



- CAUTION**
- Before switching on this instrument, make sure that the line voltage selector switch is set to the voltage of the power supply and the correct fuse is installed.
 - Always use the three-prong ac power cord supplied with this instrument. Failure to ensure adequate earth grounding by not using this cord may cause instrument damage.
-



The instruction documentation symbol. The product is marked with this symbol when it is necessary for the user to refer to the instructions in the documentation.

- CE The CE mark is a registered trademark of the European Community. (If accompanied by a year, it is when the design was proven.)
- ISM1-A This is a symbol of an Industrial Scientific and Medical Group 1 Class A product.
- CSA The CSA mark is a registered trademark of the Canadian Standards Association.
-

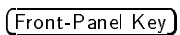
Manual Conventions

-  This represents a key physically located on the instrument.
-  This indicates a “softkey,” a key whose label is determined by the firmware of the instrument.
- Screen Text This indicates text displayed on the instrument’s screen.

EMI Receiver Series Documentation Description

The following documents are provided with either the HP 8542E/HP 8546A EMI receiver or the HP 85422E/HP 85462A receiver RF section.

- *Installation and Verification* provides information for installing your instrument, verifying instrument operation, and customer support.
- *User's Guide* describes instrument features and how to make measurements with your EMI receiver or receiver RF section.
- *Reference* provides specifications and characteristics, menu maps, error messages, and key descriptions.
- *Programmer's Guide* provides information on remote control instrument configuration, creating programs, and parameters for each of the programming commands available.

Contents

1. Preparing for Use

What You'll Learn in This Chapter	1-1
Connecting Your Instrument to a Computer	1-1
Configuring Your Computer System	1-1
Connecting the Computer to the Instrument	1-1
For the HP-IB Interface	1-1
For the RS-232 Interface	1-1
The Test Program	1-2
HP-IB Connections for the HP 9000 Series 200 Technical Computers	1-3
Equipment	1-3
Interconnection Instructions	1-3
Test Program	1-3
HP-IB Connections for the HP 9000 Series 300 Technical Computers	1-5
Equipment	1-5
Interconnection Instructions	1-5
Test Program	1-6
HP-IB Connections for the HP Vectra Personal Computer	1-7
Equipment	1-7
Interconnection Instructions	1-7
Test Program	1-7
RS-232 Connections for the HP Vectra Personal Computer	1-9
Equipment	1-9
Interconnection Instructions	1-9
Test Program	1-9
RS-232 Connections for the IBM PC/AT and Compatible Computers	1-11
Equipment	1-11
Interconnection Instructions	1-11
Test Program	1-11
Printing or Plotting	1-13
Printer with an HP-IB Interface	1-13
Equipment	1-13
Interconnection and Printing Instructions	1-13
Plotter with an HP-IB Interface	1-14
Equipment	1-14
Interconnection and Plotting Instructions	1-14
Printer with an RS-232 Interface	1-15
Equipment	1-15
Interconnection and Printing Instructions	1-15
Plotter with an RS-232 Interface	1-16
Equipment	1-16
Interconnection and Plotting Instructions	1-16
Printing after Plotting or Plotting after Printing	1-17
If There is a Problem	1-18

2. Writing a Program	
What You'll Learn in This Chapter	2-1
Writing Your First Program	2-2
Composing the Program	2-2
Program Example for the HP-IB Interface	2-2
Modifying the Program	2-4
Program Example for the HP-IB Interface	2-4
Enhancing the Program with Variables	2-5
Program Example for the HP-IB Interface	2-5
Getting Information from the Instrument	2-6
Program Example for the HP-IB Interface	2-6
Programming Guidelines	2-8
3. Programming Topics	
What You'll Learn in This Chapter	3-1
Controlling Trace Data with a Computer	3-2
Reading Trace Data	3-2
Program Example for the HP-IB Interface	3-2
Saving Trace Data	3-3
Reading Trace Data from a Computer Disk	3-4
Program Example for the HP-IB Interface	3-4
Saving and Recalling Instrument States	3-5
Saving the Instrument's State	3-5
Program Example for the HP-IB Interface	3-5
Returning the Instrument to its Former State	3-7
Program Example for the HP-IB Interface	3-7
Different Formats for Trace Data Transfers	3-8
P Format	3-8
Example of Using the P Format	3-8
B Format	3-9
Example of Using the B Format	3-9
A-Block Format	3-10
Example of Using the A-Block Format	3-11
I-Block Format	3-11
Example of Using the I-Block Format	3-11
M Format	3-12
Example of Using the M Format	3-14
4. Programming Commands	
What You'll Learn in This Chapter	4-1
Syntax Conventions	4-2
ABS Absolute	4-25
ADD Add	4-27
AMB Trace A Minus Trace B	4-29
AMBPL Trace A Minus Trace B Plus Display Line	4-32
AMPCOR Amplitude Correction	4-34
AMPLEN Amplitude Correction Length	4-37
ANNOT Annotation	4-38
APB Trace A Plus Trace B	4-39
ARNG Auto Range	4-40
AT Attenuation	4-41
AUNITS Amplitude Units	4-43
AUTO Auto Couple	4-45
AUTOAVG Auto Average	4-47
AUTOCAL Automatic Calibration	4-48

AUTOQPD Quasi-Peak Detector	4-49
AVBW Average Video Bandwidth	4-50
AVG Average	4-52
AXB Exchange Trace A and Trace B	4-54
BAUDRATE Baud Rate of Instrument	4-55
BIT Bit	4-57
BITF Bit Flag	4-59
BLANK Blank Trace	4-61
BML Trace B Minus Display Line	4-62
BTC Transfer Trace B to Trace C	4-63
BXC Trace B Exchange Trace C	4-64
BYPASS Bypass Path	4-65
CAL Calibration	4-66
CALCHECK Calibration Check	4-69
CALSW Calibration Switch	4-70
CALTIME Calibration Time	4-71
CAT Catalog	4-72
CF Center Frequency	4-76
CLRAVG Clear Average	4-78
CLRW Clear Write	4-79
CLS Clear Status Byte	4-80
CNTLA Auxiliary Interface Control Line A	4-81
CNTLB Auxiliary Interface Control Line B	4-82
CNTLC Auxiliary Interface Control Line C	4-83
CNTLD Auxiliary Interface Control Line D	4-84
CNTLI Auxiliary Interface Control Line Input	4-85
COMPRESS Compress Trace	4-86
CONCAT Concatenate	4-88
CONTS Continuous Sweep	4-90
CORREK Correction Factors On	4-91
COUPLE Couple	4-92
CTA Convert to Absolute Units	4-93
CTM Convert to Measurement Units	4-95
DATEMODE Date Mode	4-96
DEMOD Demodulation	4-97
DET Detection Mode	4-98
DISPOSE Dispose	4-100
DIV Divide	4-101
DL Display Line	4-103
DN Down	4-105
DONE Done	4-106
EDITANNOT Edit Annotation	4-108
EK Enable Knob	4-109
EP Enter Parameter Function	4-110
ERASE Erase	4-111
EXITANNOT Exit Annotation	4-112
EXP Exponent	4-113
FA Start Frequency	4-116
FASTMRKR Fast Marker	4-118
FB Stop Frequency	4-119
FCALDATE Last Calibration Date	4-121
FFT Fast Fourier Transform	4-122
FMGAIN FM Gain	4-126
FOFFSET Frequency Offset	4-127
FORMAT Format Disk	4-129

FS Full Span	4-130
FSER RF Filter Section Serial Number	4-131
GRAT Graticule	4-132
HAVE Have	4-133
HD Hold Data Entry	4-135
HN Harmonic Number	4-136
HNLOCK Harmonic Number Lock	4-137
HNUNLK Unlock Harmonic Number	4-139
IB Input B	4-140
ID Identify	4-141
IFBW Intermediate Frequency Bandwidth	4-142
INT Integer	4-144
INZ Input Impedance	4-146
IP Instrument Preset	4-147
LASTKEYMENU Last Key Menu	4-150
LF Base Band Instrument Preset	4-151
LG Logarithmic Scale	4-152
LIMIAMPSCCL Limit-Line Amplitude Scale	4-153
LIMIDEL Delete Limit-Line Table	4-154
LIMIDISP Limit Line Display	4-155
LIMIFAIL Limits Failed	4-157
LIMIFRQSCCL Limit-Line Frequency Scale	4-159
LIMIFT Select Frequency or Time Limit Line	4-160
LIMIHI Upper Limit	4-161
LIMILINE Limit Lines	4-163
LIMILINESTA Limit-Line State	4-166
LIMILO Lower Limit	4-168
LIMIMARGAMP Limit Margin Amplitude	4-169
LIMIMARGSTA Limit-Margin State	4-170
LIMIMIRROR Mirror Limit Line	4-172
LIMIMODE Limit-Line Entry Mode	4-174
LIMINUM Limit-Line Number	4-176
LIMIREL Relative Limit Lines	4-177
LIMISEG Enter Limit-Line Segment for Frequency	4-179
LIMISEGT Enter Limit-Line Segment for Sweep Time	4-182
LIMITEST Enable Limit-Line Testing	4-185
LINCHK Linearity Check	4-187
LINFILL Linear	4-188
LN Linear Scale	4-190
LOAD Load	4-191
LOG Logarithm	4-193
LSPAN Last Span	4-196
LOGSWEEPSPD Log Sweep Speed	4-197
M4 Marker Zoom	4-198
MDS Measurement Data Size	4-200
MDU Measurement Data Units	4-202
MEAN Trace Mean	4-204
MEANTH Trace Mean Above Threshold	4-206
MEASALLSIGS Measure All Signals	4-208
MEASAVG Measure Average	4-209
MEASFREQ Measure Frequency	4-210
MEASPEAK Measure Peak	4-211
MEASQPD Measure Quasi-Peak Detector	4-212
MEASRESULT Measure Result	4-213
MEASSIG Measure Signal	4-215

MEASTIMEAVG Measure Time Average	4-216
MEASTIMEPK Measure Time Peak	4-217
MEASTIMEQPD Measure Time Quasi-Peak Detector	4-218
MEASURE Measure Mode	4-219
MEASWITHPP Measure With Preselector Peak	4-221
MERGE Merge Two Traces	4-222
MF Marker Frequency Output	4-224
MIN Minimum	4-226
MINH Minimum Hold	4-228
MINPOS Minimum Position	4-229
MIRROR Mirror Image	4-231
MKA Marker Amplitude	4-233
MKACT Activate Marker	4-235
MKACTV Marker As the Active Function	4-236
MKBW Marker Bandwidth	4-237
MKCF Marker to Center Frequency	4-238
MKCONT Marker Continue	4-239
MKD Marker Delta	4-240
MKF Marker Frequency	4-242
MKFC Marker Counter	4-244
MKFCR Marker Counter Resolution	4-245
MKMIN Marker Minimum	4-247
MKN Marker Normal	4-248
MKNOISE Marker Noise	4-250
MKOFF Marker Off	4-252
MKP Marker Position	4-253
MKPAUSE Marker Pause	4-255
MKPK Marker Peak	4-257
MKPX Marker Peak Excursion	4-258
MKREAD Marker Readout	4-260
MKRL Marker to Reference Level	4-262
MKSP Marker to Span	4-263
MKSS Marker to Step Size	4-264
MKSTOP Marker Stop	4-266
MKTRACE Marker Trace	4-267
MKTRACK Marker Track	4-268
MKTYPE Marker Type	4-269
ML Mixer Level	4-270
MOD Modulo	4-272
MOV Move	4-274
MPY Multiply	4-276
MSI Mass Storage Is	4-278
MXM Maximum	4-279
MXMH Maximum Hold	4-281
NRL Normalized Reference Level	4-282
OA Output Active Function Value	4-284
OL Output Learn String	4-285
OVLN Overload	4-286
PDA Probability Distribution of Amplitude	4-288
PEAKS Peaks	4-290
PLOT Plot	4-293
POWERON Power-On State	4-295
PP Preselector Peak	4-296
PREAMP Preamplifier	4-297
PREAMPG External Preamplifier Gain	4-299

PREFX Prefix	4-300
PRINT Print	4-301
PRNTADRS Print Address	4-302
PRNTPPG Prints Per Page	4-303
PRNTRES Print Resolution	4-304
PRNTTYPE Printer Type	4-305
PROTECT Protect	4-307
PSTATE Protect State	4-308
PURGE Purge File	4-309
PWRBW Power Bandwidth	4-310
PWRUPTIME Power Up Time	4-312
QPGAIN Quasi-Peak Gain	4-313
RANGE Range	4-314
RB Resolution Bandwidth	4-315
RCLC Recall Colors	4-317
RCLS Recall State	4-318
RCLT Recall Trace	4-319
RCVRRMRKR Receiver Marker Position	4-321
REMEASSIG Remeasure Signal	4-323
REPEAT UNTIL Repeat Until	4-324
RESETRL Reset Reference Level	4-326
REV Revision	4-327
RFIN RF Input Signal	4-328
RFINLK RF Input Lock	4-330
RL Reference Level	4-331
RLPOS Reference-Level Position	4-333
RMS Root Mean Square Value	4-334
ROFFSET Reference Level Offset	4-335
RPTDEF Report Definition	4-336
RQS Service Request Mask	4-337
SAVEC Save Colors	4-339
SAVES Save State	4-340
SAVET Save Trace	4-341
SEGDEL Segment Delete	4-343
SENER Segment Entry for Frequency Limit Lines	4-345
SENTERT Segment Entry for Sweep Time Limit Lines	4-348
SER Serial Number	4-351
SETC Set Colors	4-352
SETDATE Set Date	4-354
SETTIME Set Time	4-355
SHOWSETUP Show Set Up	4-356
SIGADD Signal Add	4-357
SIGDEL Signal Delete	4-358
SIGDLTAVIEW Signal Delta View	4-359
SIGGRAPH Signal Graph	4-361
SIGLEN Signal List Length	4-362
SIGLIST Signal List	4-363
SIGMARK Signal Mark	4-364
SIGPOS Signal Position	4-365
SIGRESULT Signal Result	4-366
SIGSORT Signal Sort	4-367
SIGUNMARK Signal Unmark	4-369
SMOOTH Smooth Trace	4-370
SNGLS Single Sweep	4-372
SP Span	4-373

SPEAKER Speaker	4-375
SPZOOM Span Zoom	4-376
SQLCH Squelch	4-377
SQR Square Root	4-378
SRCALC Source Leveling Control	4-380
SRCAT Source Attenuator	4-381
SRCPOFS Source Power Offset	4-383
SRCPSTP Source Power-Level Step Size	4-384
SRCPSWP Source Power Sweep	4-386
SRCPWR Source Power	4-388
SRCTK Source Tracking	4-390
SRCTKPK Source Tracking Peak	4-392
SRQ Force Service Request	4-393
SS Center Frequency Step Size	4-396
ST Sweep Time	4-398
STB Status Byte Query	4-400
STOR Store	4-401
SUB Subtract	4-404
SUM Sum of Trace Amplitudes	4-406
SUMSQR Sum of Squared Trace Amplitudes	4-408
SWEEPTYPE Sweep Type	4-409
SWPCPL Sweep Couple	4-410
TA Transfer A	4-412
TB Transfer B	4-414
TBLDEF Table Definition	4-415
TDF Trace Data Format	4-416
TH Threshold	4-421
TIMEDATE Time Date	4-423
TIMEDSP Time Display	4-424
TITLE Title	4-425
TM Trigger Mode	4-426
TRA/TRB/TRC Trace Data Input and Output	4-428
TRCMEM Trace Memory	4-430
TRDEF Trace Define	4-431
TRDSP Trace Display	4-433
TRPRST Trace Preset	4-434
TRSTAT Trace Status	4-435
TS Take Sweep	4-436
TWNDOW Trace Window	4-437
UDKDEFINE User-Defined Key	4-438
UDKSET User-Defined Key Set	4-439
UNRANGE UnRange	4-440
UP Up	4-441
VARDEF Variable Definition	4-442
VARIANCE Variance of Trace Amplitudes	4-444
VAVG Video Average	4-446
VB Video Bandwidth	4-447
VBR Video Bandwidth Ratio	4-449
VIEW View Trace	4-450
WAIT Wait	4-451
WINNEXT Window Next	4-452
WINOFF Window Off	4-453
WINON Window ON	4-454
WINZOOM Window Zoom	4-456
XCH Exchange	4-457

XUNITS Transducer Conversion Units	4-459
ZMKCNTR Zone Marker at Center Frequency	4-460
ZMKPKNL Zone Marker for Next Left Peak	4-462
ZMKPKNR Zone Marker for Next Right Peak	4-463
ZMKSPAN Zone Marker Span	4-464
5. Error Messages	
Nonrecoverable System Errors	5-12
A. HP-IB	
B. RS-232 Option 023	
What You'll Learn in This Appendix	B-1
Introducing the RS-232 Interface	B-1
The RS-232 Data Lines	B-1
The RS-232 Handshaking Lines	B-1
Baud Rate	B-2
Protocol	B-2
Connecting a ThinkJet Printer	B-3
ThinkJet Printer Mode Switches:	B-4
Connecting a Modem	B-4
System Settings	B-5
Connecting an HP-GL Plotter	B-5
Switch Settings	B-5
Setting the Instrument Baud Rate	B-5

Index

Figures

1-1. Connecting the HP 9000 Series 200 Computer to the Instrument	1-3
1-2. Connecting the HP 9000 Series 300 Computer to the Instrument	1-5
1-3. Connecting the HP Vectra Personal Computer to the Instrument	1-7
1-4. Connecting the HP Vectra Personal Computer to the Instrument	1-9
1-5. Connecting an IBM PC/AT Compatible Computer to the Instrument	1-11
3-1. Measurement Unit Range and Trace Amplitudes	3-13
4-1. Command Syntax Figure	4-2
4-2. Hanning Filter Window	4-124
4-3. Uniform Filter Window	4-125
4-4. Flat Top Filter Window	4-125
A-1. HP-IB Connector	A-1
B-1. RS-232 Connector	B-1
B-2. Full Handshaking Connection	B-3
B-3. 3-Wire Connection	B-3
B-4. ThinkJet Printer Connection	B-3
B-5. Modem Connection	B-4
B-6. HP-GL Plotter Connection	B-5

Tables

3-1. Measurement Units	3-13
3-2. Summary of the Trace Data Formats	3-14
4-1. Syntax Elements	4-3
4-2. Characters and Secondary Keywords (Reserved Words)	4-5
4-3. Summary of Compatible Commands	4-9
4-4. Functional Index	4-11
4-5. LIF or DOS File Types	4-74
4-6. LIF or DOS Data Types	4-192
4-7. Instrument Status Byte	4-394
4-8. LIF or DOS Data Types	4-403
4-9. Programming Commands That Exit The Windows Display Mode	4-455
B-1. Setting of Thinkjet Printer Mode Switches	B-4
B-2. Setting of RS-232 Switches	B-4
B-3. Setting the Baud Rate	B-4

Preparing for Use

What You'll Learn in This Chapter

This chapter tells you how to connect a computer to your instrument via the Hewlett-Packard Interface Bus (HP-IB) or the RS-232 Interface and how to connect a printer or a plotter. The remainder of the chapter covers procedures to follow if a problem is encountered.

Connecting Your Instrument to a Computer

The instrument works with many popular computers. However, the steps required to connect your instrument to a specific computer depend on the computer you are using. Before turning to the interconnection instructions for your computer, please read the following general information.

Configuring Your Computer System

Every computer system has a specific configuration. Your system configuration might include a printer, external disk drive, or plotter. Whenever you add another piece of equipment, you may need to reconfigure your computer system so that the computer knows where and how to send information to the newly added device.

Some computers do not require configuring when an instrument is connected; others require a simple modification. The most common modification is changing the configuration information stored on the computer's operating system disk. A few computers require the insertion of an add-on board, or "card." Refer to your computer documentation if your system needs these modifications.

All of the test programs for HP-IB and RS-232 interfaces are written using the BASIC language of the computer under consideration. If you have never entered or run a BASIC program, refer to your computer documentation.

Connecting the Computer to the Instrument

For the HP-IB Interface

Appendix A contains instructions for connecting the instrument's or to an HP Vectra PC equipped with an HP 82300B BASIC Language Processor. If your computer is not listed, but it supports an HP-IB interface, there is a good possibility that it can be connected to the instrument. Consult your computer documentation to determine how to connect external devices on the bus.

For the RS-232 Interface

Appendix B contains instructions for connecting the instrument's RS-232 interface to an HP Vectra PC or IBM PC/AT or compatible computers. If your computer is not listed, but it supports a standard RS-232 interface, there is a good possibility that the instrument may be connected to the computer. Consult your computer documentation to determine how to connect external devices to your computer's RS-232 connector.

There are two types of RS-232 devices: data terminal equipment (DTE) and data communication equipment (DCE). Types of DTE devices include display terminals. DCE equipment includes modems and, generally, other computer RS-232 devices. The instrument RS-232 port is the DTE-type. Connections from the computer (DCE) to the instrument (DTE) are shown in Figure 1-4.

The Test Program

To test the system configuration, a simple test program is provided for each computer listed. After you have connected your computer and instrument, you should enter and run the test program on your computer to make sure the computer is sending instructions to the instrument through the interface cable. If the interface is working and the program is entered correctly, a statement is displayed on the computer screen.

Note The listed computer and instrument equipment includes the minimum components necessary to establish communication between your instrument and computer. If you are using application software, check with your software supplier for specific computer hardware and memory requirements.

Note Using an interface cable other than the one listed with your computer's interconnection instructions may prevent proper communication between the instrument and computer.

Pressing **CONFIG** removes the instrument from remote mode and enables front-panel control.

HP-IB Connections for the HP 9000 Series 200 Technical Computers

Equipment

- HP 9816, 9826, or 9836 Series 200 technical computer
- HP 8542E/HP 8546A EMI receiver
- HP 10833 (or equivalent) HP-IB cable

Interconnection Instructions

Connect the instrument to the computer using the HP-IB cable. Figure 1-1 shows an HP 9836 computer connected to the instrument.

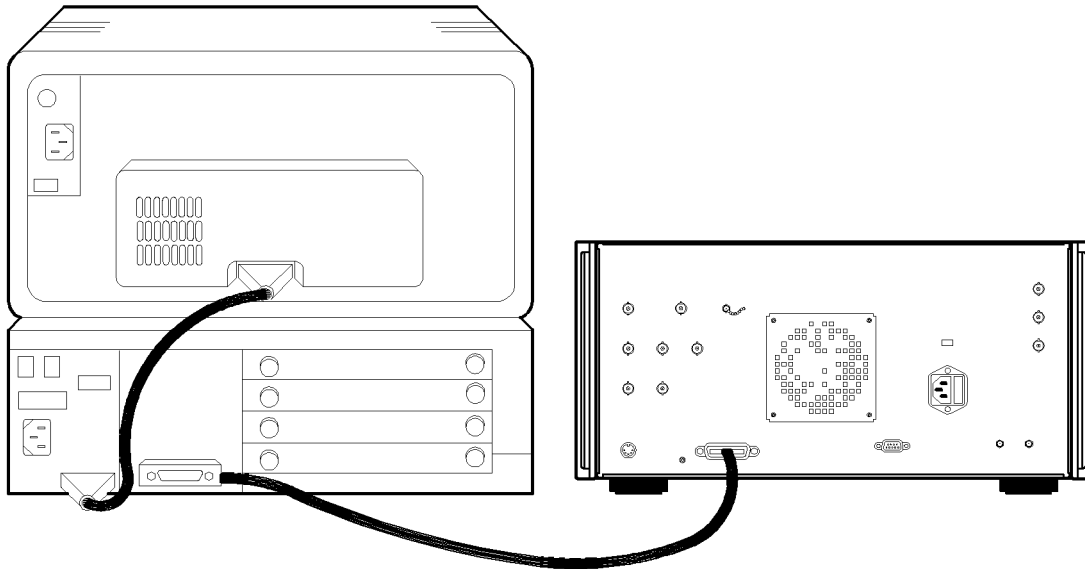

cu12e

Figure 1-1. Connecting the HP 9000 Series 200 Computer to the Instrument

Test Program

To test the connection between the computer and the instrument, turn on your instrument and follow the instructions below.

1. Your HP 9000 Series 200 computer may have either a soft-loaded or built-in language system. If your language system is built-in, remove any disks from the drives and turn on the computer.
2. If your language is soft-loaded, install the BASIC language disk into the proper drive. Turn the computer power on. After a few seconds, the BASIC READY message appears; the computer is now ready for use.

For further information on loading BASIC on your system, consult your BASIC manual.

3. Check the HP-IB address of the instrument: press **CONFIG**, **More 1 of 3**, **RECEIVER ADDRESS**. The usual address for the instrument is 18. If necessary, reset the

address of the instrument: press **CONFIG**, **More 1 of 3**, **RECEIVER ADDRESS**, **18**, **Hz** (or enter the appropriate address).

4. Enter the following program, then press **RUN** on the computer. If you need help entering and running the program, refer to your computer and software documentation.

The program shows that the computer is able to send instructions to, and read information from, the instrument.

```
10 PRINTER IS 1
20 Instrument=718
30 CLEAR Instrument
40 OUTPUT Instrument;"IP;SNGLS;"
50 OUTPUT Instrument;"CF 300MZ;TS;"
60 OUTPUT Instrument;"CF?;"
70 ENTER Instrument;A
80 PRINT "CENTER FREQUENCY = ";A;"Hz";
90 END
```

The program tells the instrument to perform an instrument preset and enter single-sweep mode. Next, the program sets the center frequency to 300 MHz and takes a sweep.

The program then queries the center frequency value and tells the computer to display CENTER FREQUENCY = 3.0E+8 Hz.

If the computer does not display the center frequency, refer to “If There is a Problem” at the end of this chapter.

HP-IB Connections for the HP 9000 Series 300 Technical Computers

Equipment

- HP 98580A, 98581A, 98582A, or 98583A Series 300 technical computer
- HP 8542E/HP 8546A EMI receiver
- HP 10833 (or equivalent) HP-IB cable

Interconnection Instructions

Connect the instrument to the computer using the HP-IB cable as shown in Figure 1-2.

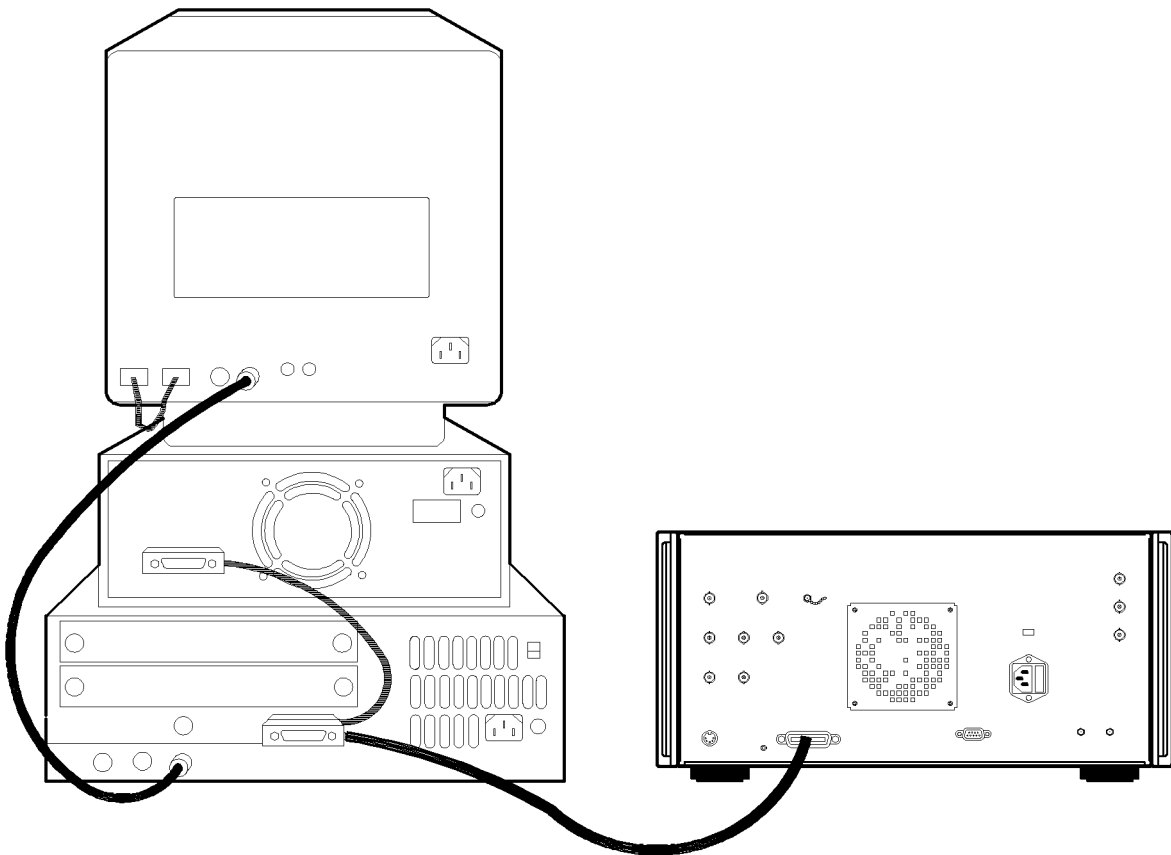

cu13e

Figure 1-2. Connecting the HP 9000 Series 300 Computer to the Instrument

Test Program

To test the connection between the computer and the instrument, turn on your instrument and follow the instructions below.

1. Your HP 9000 Series 300 computer may have either a soft-loaded or built-in language system. If your language system is built-in, remove any disks from the drives and turn on the computer.
2. If your language is soft-loaded, install the BASIC language disk into the proper drive. Turn the computer power on. After a few seconds, the BASIC READY message appears; the computer is now ready for use.

For further information on loading BASIC on your system, consult your BASIC manual.

3. Check the HP-IB address of the instrument: press **CONFIG**, **More 1 of 3**, **RECEIVER ADDRESS**. The usual address for the instrument is 18. If necessary, reset the address of the instrument: press **CONFIG**, **More 1 of 3**, **RECEIVER ADDRESS**, 18, **Hz** (or enter the appropriate address).
4. Enter the following program, then press **RUN** on the computer. If you need help entering and running the program, refer to your computer and software documentation.

The program shows that the computer is able to send instructions to, and read information from, the instrument.

```
10 PRINTER IS 1
20 Instrument=718
30 CLEAR Instrument
40 OUTPUT Instrument;"IP;SNGLS;"
50 OUTPUT Instrument;"CF 300MZ;TS;"
60 OUTPUT Instrument;"CF?;"
70 ENTER Instrument;A
80 PRINT "CENTER FREQUENCY = ";A;"Hz";
90 END
```

The program tells the instrument to perform an instrument preset and enter single-sweep mode. Next, the program sets the center frequency to 300 MHz and takes a sweep.

The program then queries the center frequency value and tells the computer to display CENTER FREQUENCY = 3.0E+8 Hz.

If the computer does not display the center frequency, refer to "If There is a Problem" at the end of this chapter.

HP-IB Connections for the HP Vectra Personal Computer

Equipment

- HP Vectra personal computer, with option HP 82300B, the HP BASIC Language Processor
- HP 8542E/HP 8546A EMI receiver
- HP 10833 (or equivalent) HP-IB cable

Interconnection Instructions

Connect the instrument to the computer using the HP-IB cable as shown in Figure 1-3.

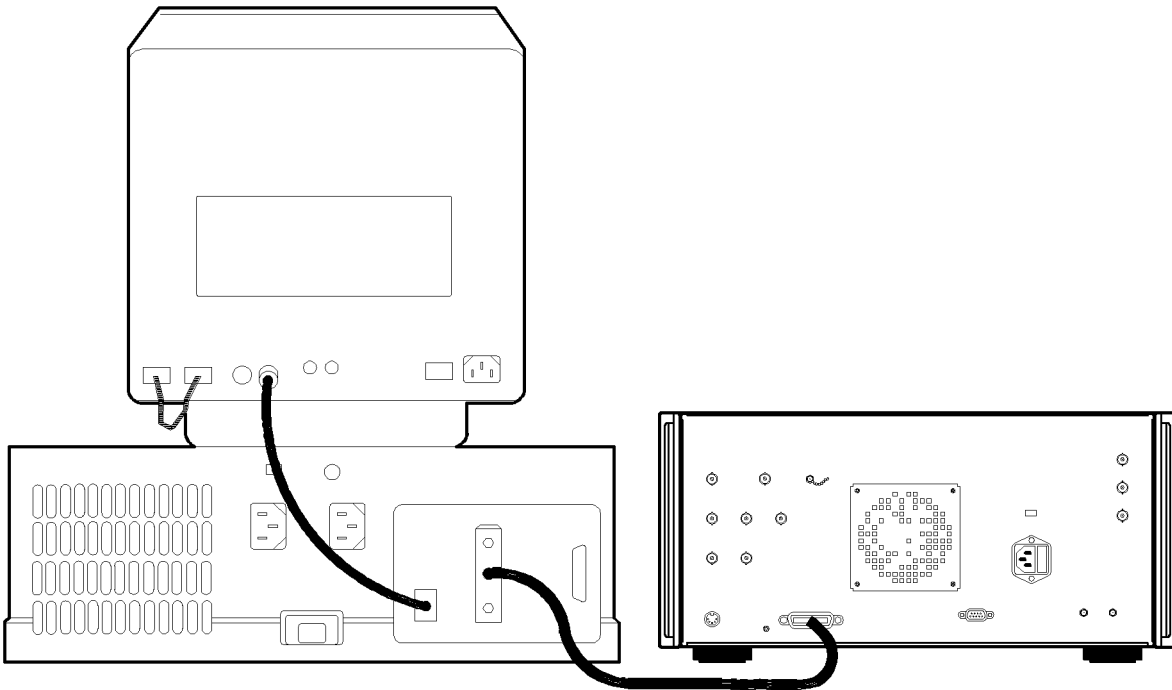

cu14e

Figure 1-3. Connecting the HP Vectra Personal Computer to the Instrument

Test Program

To test the connection between the computer and the instrument, turn on your instrument and follow the instructions below.

1. Refer to the HP 82300 Language Processor documentation to install the language processor board in your computer and load the BASIC programming language into your computer.
2. Check the HP-IB address of the instrument: press **CONFIG**, **More 1 of 3**, **RECEIVER ADDRESS**. The usual address for the instrument is 18. If necessary, reset the address of the instrument: press **CONFIG**, **More 1 of 3**, **RECEIVER ADDRESS**, 18 **Hz** (or enter the appropriate address).

3. Enter the following program, then press **(F10)** on the computer. If you need help entering and running the program, refer to your computer and software documentation.

The program shows that the computer is able to send instructions to, and read information from, the instrument.

```
10 PRINTER IS 1
20 Instrument=718
30 CLEAR Instrument
40 OUTPUT Instrument;"IP;SNGLS;"
50 OUTPUT Instrument;"CF 300MZ;TS;"
60 OUTPUT Instrument;"CF?;"
70 ENTER Instrument;A
80 PRINT "CENTER FREQUENCY = ";A;"Hz";
90 END
```

The program tells the instrument to perform an instrument preset and enter single-sweep mode. Next, the program sets the center frequency to 300 MHz and takes a sweep. The program then queries the center frequency value and tells the computer to display CENTER FREQUENCY = 3.0E+8 Hz.

If the computer does not display the center frequency, refer to “If There is a Problem” at the end of this chapter.

RS-232 Connections for the HP Vectra Personal Computer

Equipment

- HP Vectra personal computer with RS-232 interface that has an 9-pin female port
- HP 8542E/HP 8546A EMI receiver
- HP 24542G RS-232 cable

Interconnection Instructions

1. Connect the instrument to the computer using the RS-232 cable as shown in Figure 1-4.

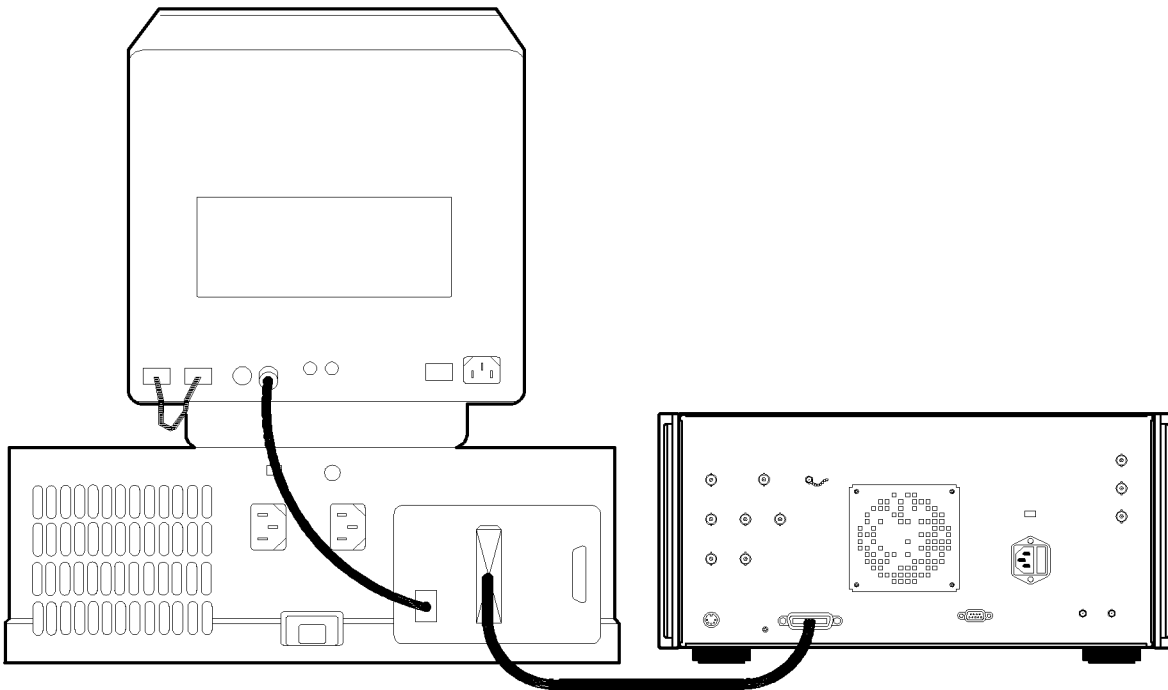

cu15e

Figure 1-4. Connecting the HP Vectra Personal Computer to the Instrument

2. Turn on the instrument and the computer.

Test Program

The program shown below works with the following computers:

- HP Vectra PC using a version of BASIC (HP 45952A) for the Vectra PC. The MS BASIC Interpreter (HP 35190A) is compatible with the version of BASIC for the Vectra PC.
- IBM PC/AT and compatible computers using BASICA (version 2.0 or later) or GW BASIC.

To test the interconnection, first load the BASIC language for your computer and specify a communications buffer of 4096 bytes. Use the following command:

```
BASICA/C:4096
```

Set the instrument baud rate to 1200, to match the baud rate set up for the computer port in the test program. In line 20, the "1200" indicates 1200 baud for the computer port. Press the following keys to set the baud rate: **CONFIG**, **More 1 of 3**, **BAUD RATE**, 1200, **Hz**.

Enter the following test program. The program shows that the computer is able to send instructions to, and read information from, the instrument.

```
10 'File = TESTPGM
20 OPEN "COM1:1200,N,8,1" AS #1
30 PRINT #1,"IP;"
40 PRINT #1,"SNGLS;"
50 PRINT #1,"CF 300MZ;TS;"
60 PRINT #1,"CF?;"
70 INPUT #1,CENTER
80 PRINT,"CENTER FREQUENCY = ";CENTER;"Hz"
90 END
```

When you have entered the program, type:

```
SAVE "TESTPGM"
```

When you are ready to run the program, turn on the instrument and run your program.

The program tells the instrument to perform an instrument preset and enter single sweep mode. Next, the program sets the center frequency to 300 MHz and takes a sweep. The program then queries the center frequency value and tells the computer to display **CENTER FREQUENCY = 3.0E+8 Hz**.

If the computer does not display the center frequency, refer to "If There is a Problem" at the end of this chapter.

RS-232 Connections for the IBM PC/AT and Compatible Computers

Equipment

- IBM PC/AT or compatible with RS-232 interface
- HP 8542E/HP 8546A EMI receiver
- HP 13242G RS-232 cable (DCE-DCE), 7 pins used (refer to Appendix B for wiring of this cable)

Interconnection Instructions

1. Connect the instrument to the computer with the RS-232 cable. (See Figure 1-5.) The instrument uses a female RS-232 connector; the IBM PC/AT computer usually uses a male RS-232 connector. Some compatibles use a female RS-232 connector.

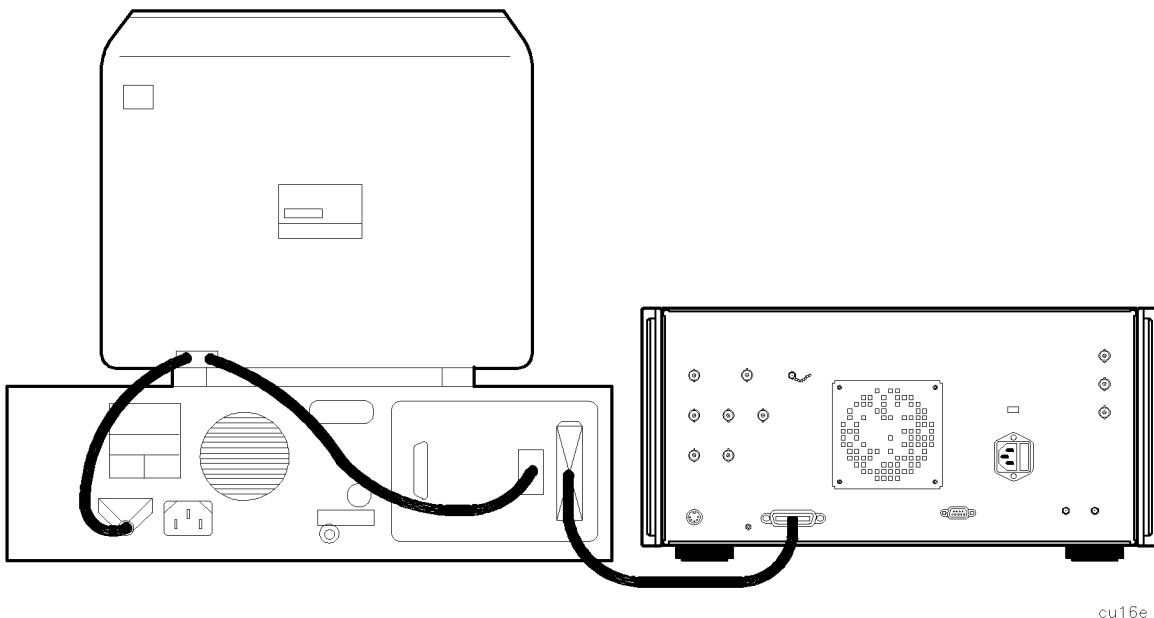

Figure 1-5. Connecting an IBM PC/AT Compatible Computer to the Instrument

2. Turn on the instrument and the computer.

Test Program

The program shown below is written to work with BASICA (version 2.0 or later) or GW BASIC.

To test the interconnection, first load the BASIC language for your computer and specify a communications buffer of 4096 bytes. Use the following command:

```
BASICA/C: 4096
```

Set the instrument baud rate to 1200, to match the baud rate set up for the computer port in the test program. In line 20, the "1200" indicates 1200 baud for the computer port. To set the baud rate to 1200 press **(CONFIG)**, **More 1 of 3**, **BAUD RATE**, 1200 **(Hz)**.

Enter the following test program.

The program shows that the computer is able to send instructions to, and read information from, the instrument.

```
10 'File = TESTPGM
20 OPEN "COM1:1200,N,8,1" AS #1
30 PRINT #1,"IP;"
40 PRINT #1,"SNGLS;"
50 PRINT #1,"CF 300MZ;TS;"
60 PRINT #1,"CF?;"
70 INPUT #1,CENTER
80 PRINT,"CENTER FREQUENCY= ";CENTER;"Hz"
90 END
```

When you have entered the program, type:

```
SAVE "TESTPGM"
```

When you are ready to run the program, turn on the instrument and run your program.

The program tells the instrument to perform an instrument preset and enter single-sweep mode. Next, the program sets the center frequency to 300 MHz and takes a sweep. The program then queries the center frequency value and tells the computer to display CENTER FREQUENCY = 3.0E+8 Hz.

If the computer does not display the center frequency, refer to "If There is a Problem" at the end of this chapter.

Printing or Plotting

You may wish to obtain a permanent record of data displayed on the screen. This can be done using the **(COPY)** key of the instrument, and a printer or plotter.

Note The HP 7470A plotter does not support 2 plots per page. If you use an HP 7470A plotter with an HP 8542E/HP 8546A EMI receiver, you can select one plot per page or four plots per page, but not 2 plots per page.

Printer with an HP-IB Interface

Equipment

- HP 8542E/HP 8546A EMI receiver
- HP 2225 ThinkJet printer or HP 3630A PaintJet color printer
- HP 10833 (or equivalent) HP-IB cable

Interconnection and Printing Instructions

1. Turn off the printer and the instrument.
2. Connect the printer to the instrument using the HP-IB cable.

Note Because HP-IB cables can be connected together, more than one instrument can communicate on the HP-IB. This means that both a printer and a plotter can be connected to the instrument (using two HP-IB cables). Each device must have its own HP-IB address.

Note Because the instrument cannot print or plot with two controllers (the computer and the instrument) connected, the computer must be disconnected from the HP-IB.

3. Turn on the instrument and printer.
4. On the instrument, press **(CONFIG)**, **Print Config**.
5. The printer usually resides at the first device address. To enter address 1 for the printer, press **PRINTER ADDRESS**, **1**, **(Hz)**.
6. If the instrument is connected to an HP PaintJet printer and you want a color printout, press, **Printer Type**, **More 1 of 3**, **PAINTJET**. If the instrument is connected to an HP PaintJet printer and you want a black and white printout press, **Print Options**, then press **COLOR MONOCHRM** until MONOCHRM is underlined.
7. If you want the softkey labels to be printed with the display printout, press **PRT MENU ON OFF** so that ON is underlined.
8. Press **Previous Menu**, **Previous Menu**, **COPY DEV PRNT PLT** (PRNT should be underlined), then **(COPY)**.

Plotter with an HP-IB Interface

Equipment

- HP 8542E/HP 8546A EMI receiver
- HP 7440A ColorPro plotter
- HP 10833 (or equivalent) HP-IB cable

Interconnection and Plotting Instructions

1. Turn off the plotter and the instrument.
2. Connect the plotter to the instrument using the HP-IB cable.

Note Instrument can communicate on the HP-IB. This means that both a printer and a plotter can be connected to the instrument (using two HP-IB cables). Each device must have its own HP-IB address.

Note Because the instrument cannot print or plot with two controllers (the computer and the instrument) connected, the computer must be disconnected from the HP-IB.

3. Turn on the instrument and the plotter.
4. On the instrument, press **CONFIG**, **Plot Config**.
5. The plotter usually resides at the fifth device address. To set the plotter address, press **PLOTTER ADDRESS**, 5, **(HZ)**, to enter the address 5 for the plotter.
6. With **PLTS/PG 1 2 4**, you can choose a full-page, half-page, or quarter-page plot. Press **PLTS/PG 1 2 4** to underline the number of plots per page desired.
7. If two or four plots per page are chosen, a function is displayed that allows you to select the location on the paper of the plotter output. If two plots per page are selected, then the **PLT [] LOC _ _** function is displayed. If four plots per page are selected, then the **PLT [] _LOC _ _** is displayed. Press the softkey until the rectangular marker is in the desired section of the softkey label. The upper and lower sections of the softkey label graphically represent where the plotter output will be located.

Note For a multi-pen plotter, the pens of the plotter draw the different components of the screen as follows:

Pen Number	Description
1	Draws trace A, the active function, markers, display line, and softkeys.
2	Draws limit 2, status and error messages.
3	Draws limit 1 and the annotation.
4	Draws the graticule.
5	Draws trace C.
6	Draws trace B.

8. Press **Previous Menu** , **COPY DEV PRNT PLT** (PLT should be underlined), then **COPY**.

Note Once the address of the printer and plotter have been entered, the instrument remembers these addresses even though the power is turned off. There is no need to reenter them when the instrument is turned off and on.

Printer with an RS-232 Interface

Equipment

- HP 8542E/HP 8546A EMI receiver
- HP 2225 ThinkJet printer with an RS-232 interface, or HP 3630A PaintJet color printer with an RS-232 interface

Note Refer to Appendix B of this manual for the appropriate RS-232 cable connectors.

Interconnection and Printing Instructions

1. Turn off the instrument and the printer.

Note The RS-232 interface allows only one device (either the printer or the plotter) to be connected to the instrument.

2. Connect the printer using an RS-232 cable.
3. Turn on the instrument and printer.
4. Press **CONFIG**, **More 1 of 3**.
5. To set the baud rate to 9600 baud, press **BAUD RATE**, 9600, **Hz**. To set the baud rate to 1200 baud, press: **BAUD RATE**, 1200, **Hz**.

Note Some of the programs in this manual utilize 1200 baud. If your system uses the RS-232 handshake lines, you can use 9600 baud for all of the programs.

6. Press **CONFIG**, **Print Config**.
7. If the instrument is connected to an HP PaintJet printer and you want a color printout, press **Printer Type**, **More 1 of 3**, **PAINTJET**. If the instrument is connected to an HP PaintJet printer and you want a black and white printout, press **Print Options** then **COLOR MONOCHRM**.
8. If you want the softkey labels to be printed with the display print out, press **PRT MENU ON OFF** so that ON is underlined.
9. Press **Previous Menu**, **Previous Menu**, **COPY DEV PRNT PLT** (PRNT should be underlined), then **COPY**.

Plotter with an RS-232 Interface

Equipment

- HP 8542E/HP 8546A EMI receiver
- HP 7440A ColorPro plotter with an RS-232 interface

Note Refer to Appendix B of this manual for the appropriate RS-232 cable connectors.

Interconnection and Plotting Instructions

1. Turn off the instrument.

Note The RS-232 interface allows only one device (either the printer or the plotter) to be connected to the instrument.

2. Connect the plotter using an RS-232 cable.
3. Turn on the instrument and the plotter.
4. Press **CONFIG**, **More 1 of 3**.
5. To set the baud rate to 9600 baud, press **BAUD RATE**, 9600, **Hz**. To set the baud rate to 1200 baud, press: **BAUD RATE**, 1200, **Hz**.

Note Some of the programs in this manual utilize 1200 baud. If your system uses the RS-232 handshake lines, you can use 9600 baud for all of the programs.

6. Press **CONFIG**, **Plot Config**. You can choose a full-page, half-page, or quarter-page plot with the **PLTS/PG 1 2 4** softkey. Press **PLTS/PG 1 2 4** to underline the number of plots per page desired.

7. If two or four plots per page are chosen, a function is displayed that allows you to select the location on the paper of the plotter output. If two plots per page are selected, then the `PLT [] LOC _ _` function is displayed. If four plots per page are selected, then the `PLT [] _LOC _ _` is displayed. Press the softkey until the rectangular marker is in the desired section of softkey label. The upper and lower sections of the softkey label graphically represent where the plotter output will be located.

Note For a multi-pen plotter, the pens of the plotter draw the different components of the screen as follows:

Pen Number	Description
1	Draws the annotation and graticule.
2	Draws trace A.
3	Draws trace B.
4	Draws trace C and the display line.
5	Draws the lower-limit line.
6	Draws the upper-limit line.

-
8. Press `Previous Menu`, `COPY DEV PRNT PLT` (so that PLT is underlined), then `COPY`.

Printing after Plotting or Plotting after Printing

Pressing `COPY` without changing `COPY DEV PRNT PLT` produces the function last entered (a print or a plot).

- To print after doing a plot, press `CONFIG`, `COPY DEV PRNT PLT` (so that PRNT is underlined), then `COPY`.
- To plot after printing, press `CONFIG`, `COPY DEV PRNT PLT` (so that PLT is underlined), and `COPY`.

If There is a Problem

This section offers suggestions to help get your computer and instrument working as a system. The test programs provided in this chapter let you know if the connection between the computer and the instrument interconnection is working properly.

If the test program does not run, try the following suggestions:

1. You may need to modify the program syntax to work with your computer. Refer to your BASIC manual for correct syntax.
2. The program must be executed correctly. Refer to your computer manual for information about program execution.
3. Check your program for errors.

If the test program runs on the computer, but the instrument does not respond, try the following suggestions:

1. Make sure the instrument is turned on. If the instrument has power, the green indicator light located on the line switch is on.
2. Make sure the interface cable is connected securely. Check the interface cable for defects. Make sure the correct cable is used.
3. If you are using an HP-IB interface, the instrument must be set to the correct address setting. Press `(CONFIG)`, `More 1 of 3`, `RECEIVER ADDRESS`.
4. If you are using the RS-232 interface, check the instrument baud rate. Refer to Appendix B for information about setting the baud rate on the instrument.
5. If a program in user memory is suspected of causing problems, press `(CONFIG)`, `More 1 of 3`, `Dispose User Mem`, `DISPOSE USER KEY`, `ERASE STATEALL`, and `ERASE TRACEALL` this erases all user programs, variables, and user-defined traces that are in instrument memory.
6. If you wish to reset the instrument configuration to the state it was in when it was originally shipped from the factory, use `DEFAULT CONFIG`. To access `DEFAULT CONFIG`, press `(CONFIG)`, `More 1 of 3`, `DEFAULT CONFIG`, `DEFAULT CONFIG`. (`DEFAULT CONFIG` requires a double key press.)

If you suspect your computer is causing the problems, check it by running a program that you know works. If your system still has problems, contact your HP salesperson. Your salesperson will either be able to help solve the problem or refer you to someone who can.

Writing a Program

What You'll Learn in This Chapter

This chapter introduces instrument programming. The first section of this chapter, "Writing Your First Program," helps you write your first instrument program and introduces programming fundamentals. The second section, "Getting Information from the Instrument," shows how to get data out of the instrument. A summary at the end of this chapter reviews the programming guidelines introduced.

If the computer is not connected to the instrument, follow the instructions in Chapter 1.

A general knowledge of the BASIC programming language and the instrument is recommended before reading this chapter. Refer to your software documentation manuals for more information about BASIC. For reference, Chapter 4 provides instrument commands in alphabetical order.

Note All programming examples in this chapter for the HP-IB interface are written in HP BASIC 4.0, using an HP 9000 Series 200 computer.

Writing Your First Program

When the instrument has been connected to a computer via HP-IB interface, the computer can be used to send instructions to the instrument. These instructions tell the instrument such things as frequency span, intermediate frequency bandwidth, and sweep mode. If a properly selected sequence of instructions is sent to the instrument, a measurement is made. Sequences of coded instructions are called programs.

Composing the Program

Most programs contain several common statements, or “commands,” that address the instrument, preset it, and select its sweep mode. As an example, we will write a short program that executes only these common commands.

The following programs are for the HP-IB interfaces. Note the quotation marks that contain instrument commands in each line. Also note the semicolons at the end of each line, inserted at the end of each set of commands within the quotation marks. Using semicolons makes programs easier to read, prevents command misinterpretation, and is recommended by IEEE Standard 728.

Note In commands where quotation marks occur, the computer recognizes data as character data and not BASIC programming language commands.

Program Example for the HP-IB Interface

```
05 !File: "IBPROG1"
10 Instrument=718
20 CLEAR Instrument
30 OUTPUT Instrument;"IP;"
40 OUTPUT Instrument;"SNGLS;TS;"
50 LOCAL 7
60 END
```

Line 10 of our program assigns a variable called “Instrument” to our instrument at address 718. This instruction is followed by the HP BASIC CLEAR command, which resets the instrument on the HP-IB. With these two program lines, we have set up a clear communication path between the computer and the instrument.

Line 30 introduces the instrument preset (IP) command, which corresponds to the **PRESET** key on the instrument. The IP command sets all of the analog parameters of the instrument to known values and provides a good starting point for every measurement.

Note

Most softkey functions on the instrument have corresponding programming commands. As you continue programming, you will learn the command names that correspond to the front-panel keys and softkeys.

Line 40 activates the single-sweep mode. Most remotely controlled measurements require control of the sweep. Once SNGLS has activated the single-sweep mode, take sweep (TS) starts and completes one full sweep. TS maintains absolute control over the sweep, which is necessary for accurate computer data transfer and reduced program execution time.

Before we end the program, we return the instrument to front-panel control with line 50, LOCAL 7. The LOCAL command corresponds to the **CONFIG** (LOCAL) key on the front panel of the instrument. (LOCAL 7 commands everything on the bus to go to local mode.)

Finally, in line 60, we end the program with the END command. (If you forget to include the END command, the computer will give an error message.)

Enter the program lines, press **RUN** on the computer, and watch the display as it completes each instruction.

Modifying the Program

Remote operation of the instrument is similar to manual operation. Remote measurements are executed by commands that correspond to front-panel keys and softkeys.

The first chapter in the instrument operating manual shows you how to make a simple measurement using the calibration signal. We can add instructions to our program so that it will make the same measurement. (Because the manual process closely resembles that of the program, you may want to review “Making a Measurement” in the *EMI Receiver Series User's Guide*.)

By inserting a few lines into the initial program, we can set functions such as the center frequency and span, and we can activate a marker to find a signal's frequency and amplitude.

Program Example for the HP-IB Interface

First, we set the center frequency to 300 MHz. The CF command corresponds to the center frequency function, `CENTER FREQ`. (All instrument commands, such as CF, are described in Chapter 4.

Insert the following program line between lines 40 and 50:

```
41 OUTPUT Instrument;"CF 300MZ;"
```

Next, we set the span to 200 MHz with the SP command. Add the following program line:

```
42 OUTPUT Instrument;"SP 200MZ;"
```

Because we are controlling the sweep, we must update the display screen with the following program line:

```
43 OUTPUT Instrument;"TS;"
```

When the program is executed, the instrument takes one full sweep before executing line 41. Line 41 changes the center frequency to 300 MHz, and line 42 changes the span to 200 MHz.

Enter the following program line to place a marker at the highest peak on the trace with a MKPK HI command:

```
44 OUTPUT Instrument:"MKPK HI;"
```

The completed program is shown below:

```
05 !File: "IBPROG2"  
10 Instrument=718  
20 CLEAR Instrument  
30 OUTPUT Instrument;"IP;"  
40 OUTPUT Instrument;"SNGLS;TS;"  
41 OUTPUT Instrument;"CF 300MZ;"  
42 OUTPUT Instrument;"SP 200MZ;"  
43 OUTPUT Instrument;"TS;"  
44 OUTPUT Instrument:"MKPK HI;"  
50 LOCAL 7  
60 END
```

Run the program to make the measurement. Watch the display as it completes each instruction. Notice that the program executes the instructions faster than is possible from the front panel.

When a certain measurement is repeated often, a computer program can save time. In addition, the computer is less likely to make an error than an operator manually entering the same instructions from the front panel.

Enhancing the Program with Variables

In the last program, specific center frequency and span values were set. By modifying the program, we can cause different values to be set each time the program is run.

Program Example for the HP-IB Interface

In the following program, the exclamation point (!) allows the words that follow to be ignored by the computer. Thus, they serve as comments in the program.

```
10  !FILE: "VAR10"
20  REAL C_freq,S_pan  !define the variables
30  Instrument=718
40  CLEAR Instrument
50  OUTPUT Instrument;"IP;SNGLS;TS;"
60  !ask for the desired center frequency:
70  INPUT "CENTER FREQUENCY(MHz)?",C_freq
80  !ask for the desired span:
90  INPUT "SPAN(MHz)?",S_pan
100 !send the center frequency and span to the
110 !instrument and take a sweep to update the
120 !screen:
130 OUTPUT Instrument;"CF ";C_freq;"MZ;"
140 OUTPUT Instrument;"SP ";S_pan;"MZ;"
150 OUTPUT Instrument;"TS;"
160 !find the signal peak with peak search:
170 OUTPUT Instrument;"MKPK HI;"
180 LOCAL 7
190 END
```

Three modifications are made to the previous program so it includes center frequency and span variables. First, using the HP BASIC REAL command, we define two variables, C_freq and S_pan. The frequency and span parameters are stored in these variables. (Refer to line 20.)

Second, using the HP BASIC INPUT command, we prompt the user to enter the desired center frequency and span. The center frequency and span values are entered on the computer; because the measurement units will be entered by the program, the user does not enter them. (See lines 70 to 140.)

Third, we modify the output parameter statements so that the values stored in C_freq and S_pan are sent to the instrument. (See lines 130 to 140.)

A sweep is taken after the parameters are sent to the instrument, to ensure that the screen is updated before the marker is placed on the highest signal peak.

Getting Information from the Instrument

The first part of this chapter demonstrated techniques for setting instrument parameters. This section demonstrates a technique for getting information out of the instrument.

For example, in the second program of this chapter, we placed a marker at the highest peak of a trace and the value of the marker could be read in the upper right-hand corner of the instrument display. In the following program, we will add some commands that will read the marker's frequency and amplitude value and return those values to the computer.

Program Example for the HP-IB Interface

```
10 !FILE: "MKR"
20 REAL A_mpmarker,F_reqmarker !define variables
30 Instrument=718
40 OUTPUT Instrument;"IP;"
50 !set the output format of the instrument for
60 !real numbers:
70 OUTPUT Instrument;"TDF P;"
80 !set the instrument parameters:
90 OUTPUT Instrument;"SNGLS;"
100 OUTPUT Instrument;"CF 300MZ;"
110 OUTPUT Instrument;"SP 200MZ;"
120 OUTPUT Instrument;"TS;"
130 OUTPUT Instrument;"MKPK HI;"
140 !ask the instrument for the marker's
150 !amplitude value:
160 OUTPUT Instrument;"MKA?;"
170 !send the amplitude value to the computer:
180 ENTER Instrument;A_mpmarker
190 !ask the instrument for the marker's
200 !frequency value:
210 OUTPUT Instrument;"MKF?;"
220 !send the frequency value to the computer:
230 ENTER Instrument;F_reqmarker
240 !print the amplitude and frequency:
250 PRINT "THE SIGNAL PEAK IS ";A_mpmarker;
260 PRINT " dB $\mu$ V AT ";F_reqmarker/1.E+6;" MHz"
270 !set the instrument to continuous sweep mode:
280 OUTPUT Instrument;"CONTS;"
290 LOCAL 7
300 END
```

First, using the HP BASIC REAL command, we define two variables, A_mpmarker and F_reqmarker. The amplitude and frequency values of the marker are stored in these variables. (See line 20.)

Second, we set the output format of the instrument for real numbers with the instrument's trace data format (TDF) command. (See line 70.) As in our original program, we set the center frequency and span values. A sweep is taken and the marker is placed on the trace.

Next, we ask the instrument for the amplitude value of the marker. We have the instrument send the marker amplitude value to the computer. Note that there can be only one instrument query per programming line. We also ask the instrument for the frequency value of the marker, and we have the instrument send the marker frequency value to the computer. (See lines 100 through 230.)

Finally, we print the values on the computer screen:

```
"THE SIGNAL PEAK IS ... dB $\mu$ V AT ... MHz"
```

Before we end the program, we return the instrument to continuous-sweep mode and local control.

Programming Guidelines

1. Perform the measurement manually, keeping track of the sequence of functions used.
2. In the written program, execute an instrument preset (IP) and set single-sweep mode (SINGLS) before setting other instrument functions.
3. Use variables for function values. List variables at the beginning of the program.
4. Activate instrument functions in logical order. Place quotation marks around instrument commands. Separate commands with semicolons.
5. After setting instrument functions, execute a take sweep (TS) command before reading data or activating markers.
6. The instrument can return only one value per programming line. Do not have more than one query per programming line.
7. Use the exclamation point (!) to include comment lines when using HP BASIC. Use the apostrophe (') or REM to create comment lines when using GW BASIC. (The use of the exclamation point and the apostrophe to create comment lines are dependent on the controller and the programming language [not interface-dependent] and may be different for your system.)

Programming Topics

What You'll Learn in This Chapter

This chapter contains the following advanced programming techniques and topics.

- An example of moving and saving trace data from the instrument into the computer.
- An example of how instrument states are saved with the computer, then returned to the instrument.
- An example of reading trace data from a computer disk.
- An example of saving and recalling instrument states.
- An example of returning the instrument to its former state.
- A summary of using different formats for trace data transfers.

Many of the programming suggestions discussed in Chapter 2 have been incorporated into the programs in this chapter.

Note All programming examples for the HP-IB interface in this chapter are written in HP BASIC 4.0.

A general knowledge of the BASIC programming language is recommended before reading this chapter. (Refer to your software documentation manuals.) Chapter 4 defines instrument commands alphabetically.

Controlling Trace Data with a Computer

Using sample programs, this section shows you how to read trace data and store the data with your computer.

Reading Trace Data

The following program, which has been annotated with comments, reads a trace from the instrument and stores the trace data in a variable.

Program Example for the HP-IB Interface

```
10 !FILE: "IBPROG5"
20 !create a 401 point trace array:
30 REAL Trace_a(1:401)
40 Instrument=718
50 OUTPUT Instrument;"IP;"
60 !set the output format of the instrument for
70 !real numbers:
80 OUTPUT Instrument;"TDF P;"
90 !set the instrument parameters:
100 OUTPUT Instrument;"SNGLS;"
110 OUTPUT Instrument;"CF 300MZ;"
120 OUTPUT Instrument;"SP 200MZ;"
130 OUTPUT Instrument;"TS;"
140 OUTPUT Instrument;"MKPK HI;"
150 !move peak to center of screen:
160 OUTPUT Instrument;"MKCF;"
170 OUTPUT Instrument;"TS;"
180 !ask the instrument for trace data:
190 OUTPUT Instrument;"TRA?;"
200 !send the trace data to the computer:
210 ENTER Instrument;Trace_a(*)
220 OUTPUT Instrument;"CONTS;"
230 LOCAL 7
240 END
```

Trace data can be read with the computer by making three changes to the program created in Chapter 2. First, we modify the program to create a 401-point trace array, called `Trace_a`, in which the trace data will be stored. Second, the program uses the `TRA` command to request trace A data. (The `MKA` and `MKF` commands from the previous program have been deleted.) Third, the instrument sends trace A data to the variable, `Trace_a`.

Saving Trace Data

The trace data in the previous program can be stored on a computer disk by making three program modifications.

```
10 !FILE: "IBPROG6"
20 !create a 401 point trace array:
30 REAL Trace_a(1:401)
40 Instrument=718
50 OUTPUT Instrument;"IP;"
60 !set the output format of the instrument for
70 !real numbers:
80 OUTPUT Instrument;"TDF P;"
90 !set the instrument parameters:
100 OUTPUT Instrument;"SNGLS;"
110 OUTPUT Instrument;"CF 300MZ;"
120 OUTPUT Instrument;"SP 200MZ;"
130 OUTPUT Instrument;"TS;"
140 OUTPUT Instrument;"MKPK HI;"
150 !move peak to center of screen:
160 OUTPUT Instrument;"MKCF;"
170 OUTPUT Instrument;"TS;"
180 !ask the instrument for trace data:
190 OUTPUT Instrument;"TRA?;"
200 !send the trace data to the computer:
210 ENTER Instrument;Trace_a(*)
220 !create file to store trace
230 !file is 13 records long:
240 CREATE BDAT "DATA_A",13
250 !assign path for the file:
260 ASSIGN @File TO "DATA_A"
270 !send trace data to the file:
280 OUTPUT @File;Trace_a(*)
290 OUTPUT Instrument;"CONTS;"
300 LOCAL 7
310 !close file:
320 ASSIGN @File TO *
330 END
```

First, using the CREATE command, we create an empty file on the disk for storing the trace. The file is 13 records long. (To determine the number of records, the 401-point trace is multiplied by 8 bytes per point, the storage required for real numbers, then divided by 256 bytes per record. The result is rounded to the next largest integer.)

Next, we assign an input and an output path to the file DATA_A. Then, we send the trace data to the file. (See lines 260 through 280.) Finally, in line 320, we close the file.

Note If a program containing the CREATE command is run twice, the computer will report an error the second time because the file already exists. To prevent this error, place an exclamation mark before the CREATE command to “comment out” the line after the first run. (See line 240.)

Reading Trace Data from a Computer Disk

If we want to return trace data to the instrument for later viewing, we must work the “saving” process in reverse. The following program reads a trace previously stored on a computer disk and stores the trace in an array variable.

Program Example for the HP-IB Interface

```
10 !FILE: "IBPROG7"
20 !create a 401-point trace array:
30 REAL Trace_a(1:401)
40 !assign path to the file with the
50 !trace in it:
60 ASSIGN @File TO "DATA_A"
70 !enter trace into variable Trace_a:
80 ENTER @File;Trace_a(*)
90 !close file:
100 ASSIGN @File TO *
110 END
```

First, in line 30, the program creates a 401-point trace array. Then, in line 60, the program assigns a path to the trace file. Finally, in line 80, the program sends the trace data to the variable Trace_a(*).

Saving and Recalling Instrument States

The instrument's control settings (or its "state") can be saved with a computer and retrieved later to streamline test sequences or repeat manual measurements. Control settings can be stored in one of eight state registers in the instrument, in computer memory, or on a computer disk.

The first program in this section demonstrates techniques for saving an instrument state, along with its current trace A data. The second program demonstrates how the state information and the trace data is read from the computer and returned to the instrument.

If you wish to save states in the instrument, see the descriptions of the save state (SAVES) and recall state (RCLS) commands in Chapter 4.

Saving the Instrument's State

The following two programs read and store a trace from the instrument.

Program Example for the HP-IB Interface

```
10 !FILE: "IBPROG8"
20 !define 202 character string:
30 DIM Learn_string$(202)
40 !create 401-point array to store trace:
50 INTEGER Trace_a(1:401)
60 Instrument=718
70 !set output format for two byte integers:
80 OUTPUT Instrument;"TDF B;"
90 !ask instrument for trace data:
100 OUTPUT Instrument;"TRA?;"
110 !send trace to the computer:
120 ENTER Instrument USING "#,W";Trace_a(*)
130 !get learnstring from instrument:
140 OUTPUT Instrument;"OL;"
150 ENTER Instrument USING "#,202A";Learn_string$
160 !create file to store trace:
170 CREATE BDAT "STATE",4
180 !assign path to the file:
190 ASSIGN @File TO "STATE"
200 !send trace to the file:
210 OUTPUT @File;Learn_string$,Trace_a(*)
220 !return output format to default mode:
230 OUTPUT Instrument;"TDF P;"
240 !close file:
250 ASSIGN @File TO *
260 END
```

The program stores the trace in the variable called Trace_a(*). The state of the instrument is stored in the variable Learn_string\$. These two variables are then saved in a file called STATE. Finally, the file is stored on a disk.

Using the data stored in STATE, the instrument settings can be reset according to the saved state. Then, using the stored trace data, trace data can be viewed on the display.

Line 30 gives the dimensions of the learn string using the HP BASIC DIM command. Learn strings for the instrument require 202 bytes of storage space. Also see the output learn string (OL) command.

Line 70 uses TDF B to format the output in binary. Binary provides the fastest data transfer and requires the least amount of memory to store data. Each data point is transferred in binary as two 8-bit bytes. The data points are in the internal representation of measurement data. (See “Different Formats for Trace Data Transfers” at the end of this chapter for more information about trace data formats.)

When the trace and state data are sent from the instrument to the computer, they must be formatted. Lines 120 and 150 format trace data with the HP BASIC USING command. In the formatting statement, “#” indicates that the statement is terminated when the last ENTER item is terminated. EOI (end-or-identify) and LF (line feed) are item terminators, and early termination will result in an inaccurate learn string. “W” specifies word format. “202A” indicates the size of the learn string.

Line 170 creates a file called STATE that is 4 records long. (To determine the number of records for the computer in our example, the 401-point trace is multiplied by 2 bytes per point and the 202-byte learn string is added to give 1004 bytes total. This total is divided by 256 bytes per record, resulting in 4 records.)

Note If the program containing the CREATE command is run twice, the computer will report an error the second time because the file already exists. To prevent this, place an exclamation mark before the CREATE command to “comment out” line 170 after the program has been executed.

Returning the Instrument to its Former State

The following programs read a trace stored in a file and load it into a variable.

Program Example for the HP-IB Interface

```
10 !FILE: "IBPROG9"
20 !define 202 character string:
30 DIM Learn_string$(202)
40 !create 401 point array to store trace:
50 INTEGER Trace_a(1:401)
60 Instrument=718
70 !assign path to the file:
80 ASSIGN @File TO "STATE"
90 !get values for Learn_string$
100 !and Trace_a(*) from disk:
110 ENTER @File;Learn_string$,Trace_a(*)
120 !send learnstring to instrument:
130 OUTPUT Instrument;"IP DONE;"
140 ENTER Instrument
150 OUTPUT Instrument;Learn_string$
160 !set single sweep mode:
170 OUTPUT Instrument;"SNGLS;"
180 !prepare instrument for a trace from
190 !the computer:
200 OUTPUT Instrument;"TRA #A";
210 !send trace to the instrument
220 OUTPUT Instrument USING "#,W";802,Trace_a(*)
230 !view trace to see it was sent:
240 OUTPUT Instrument;"VIEW TRA;"
250 !close file:
260 ASSIGN @File TO *
270 END
```

The HP-IB program reads a trace stored in the file STATE, then loads it into the variable Trace_a(*).

First, the settings of the instrument that were stored in the variable LEARN\$ are recalled. The instrument state is changed to the same state as when the trace was stored. Then previously stored trace data is returned to the instrument and the trace is viewed on the instrument screen. Finally, line 220 uses the HP BASIC USING command to format the trace data.

Different Formats for Trace Data Transfers

Two different ways to format trace data using the TDF command were introduced earlier in this chapter (TDF P and TDF B). This section describes all the available trace data formats.

The EMI receiver or receiver RF section provides five formats for trace data transfers: real number (P) format, binary (B) format, A-block format, I-block format, and measurement units (M) format.

P Format

The P format allows you to receive or send trace data in a real-number format. This is the default format when the instrument is powered up. Numbers are in dBm, dBmV, dB μ V, volts, or watts. The AUNITS command can be used to specify the amplitude units. Real-number data may be an advantage if you wish to use the data later in a program. However, data transfers using P format tend to be slow and take up a lot of memory (compared to binary format, the P format can take up to four times the amount of memory). Data is transferred as ASCII type.

Although the instrument can send the trace data to the computer as real numbers, the trace data cannot be sent back to the instrument without changing the trace data to measurement units (integers). See the following example.

Example of Using the P Format

This example sends trace data to the computer and back to the instrument using P format.

Note The instrument must be in the log amplitude scale to use the TDF P format.

1 REAL Trace_data(1:401)	<i>Declare an array for trace data.</i>
10 OUTPUT 718;"IP;CF 300MHZ;SP 20MHZ;SNGLS;TS;"	<i>Take a measurement sweep.</i>
20 OUTPUT 718;"TDF P;TRA?;"	<i>Activate the P format, output trace A data.</i>
30 ENTER 718;Trace_data(*)	<i>The computer receives trace A data from the instrument.</i>
40 OUTPUT 718;"VIEW TRA;MOV TRA,0;"	<i>To verify that the trace data is transferred back to the instrument, set trace A to zeros.</i>
50 OUTPUT 718;"RL?;"	<i>Determine the amplitude of the reference level. The amplitude of the reference level is used to change the integers sent to the instrument into real numbers.</i>
60 DISP "PRESS CONTINUE WHEN READY"	
70 PAUSE	
80 ENTER 718;Ref_level	<i>Get the reference level.</i>
90 MAT Trace_data=Trace_data-(Ref_level)	<i>These lines change the real trace data (stored in Trace_data) into integers (in measurement units).</i>
100 MAT Trace_data=Trace_data*(100)	
110 MAT Trace_data=Trace_data+(8000)	
120 OUTPUT 718;"TRA ";	<i>Sends the trace data back to the instrument in measurement units.</i>
130 OUTPUT 718;Trace_data(*)	
140 LOCAL 718	
150 END	

The trace data is sent to the computer in parameter units. A parameter unit is a standard scientific unit. For the TDF P format, the parameter unit depends on the current amplitude units (dBm, dBmV, dB μ V, V, W). Use the AUNITS command to change the units.

For more detailed information about the P format, see the description for TDF in Chapter 4.

B Format

The B format allows you to receive or send trace data in a binary format. The B format provides the fastest data transfer and requires the least amount of memory to store data. Each data point is transferred in binary as two 8-bit bytes. The data points are in the internal representation of measurement units (0 to 8000). Unlike the A-block format, the B format does not send a header. An end-of-identify (EOI) is sent with the last byte of data.

Example of Using the B Format

This example sends trace data from the instrument in B format. The trace data format must be changed to A-block format to return the trace data to the instrument. See following example.

Note It is not possible to return data to the instrument using binary format. You must use either A-block or I-block format to return the trace data to the instrument.

10 INTEGER Tra_binary(1:401)	<i>Tra_binary stores the trace data.</i>
20 ASSIGN @Sa TO 718;FORMAT OFF	
30 OUTPUT @Sa;"IP;CF 300MZ;SP 20MZ;SNGLS;TS;"	<i>Takes a measurement sweep.</i>
40 OUTPUT @Sa;"MDS W;TDF B;TRA?;"	<i>Outputs trace A data.</i>
50 ENTER @Sa;Tra_binary(*)	
60 OUTPUT @Sa;"TDF A;"	<i>Changes the trace data format to A-block format.</i>
70 OUTPUT @Sa;"MOV TRA,0;"	<i>To verify that the trace data is sent back to the instrument, move all zeros into trace A.</i>
80 DISP "PRESS CONTINUE WHEN READY"	
90 PAUSE	
100 OUTPUT @Sa USING "#,K,W";"TRA#A",802	<i>Prepares the instrument for the trace data.</i>
110 OUTPUT @Sa;Tra_binary(*)	<i>Transfers the trace data back to the instrument.</i>
120 OUTPUT @Sa;"VIEW TRA;"	
130 LOCAL 718	
140 END	

The result is transmitted as binary information. The MDS command can be used to change the data format from two 8-bit bytes to one 8-bit byte. For more detailed information about the B format and the MDS command, see the descriptions for TDF and MDS in Chapter 4.

Binary data can be converted to dBm or volts. For example, use the following equation to change the trace data (in measurement units) to a real logarithmic number (dB μ V):

$$dB\mu V = ((\text{trace data} - 8000) \times 0.01) + \text{reference level (in } dB\mu V)$$

To change the trace data (in measurement units) to linear data (volts):

$$\text{volts} = \left(\frac{\text{reference level}}{8000} \right) \times \text{trace data}$$

The following programming converts binary data to dB μ V.

```
10    ! 8546 binary data to real numbers
20    Rcvr=718
30    ASSIGN @Rcvr_bin TO Sa;FORMAT OFF
40    INTEGER Trace_a(1:401)
50    OUTPUT Rcvr;"AUNITS DBUV;"
60    OUTPUT Rcvr;"RL?;"
70    ENTER Rcvr;Ref_lev
80    PRINT Ref_lev
90    OUTPUT Rcvr;"TDF B;TRA?;"
100   ENTER @Rcvr_bin;Trace_a(*)
110   ! now the instrument has all the data
120   ! to determine the measured trace data
130   REAL Trace_a_real(1:401)
140   MAT Trace_a_real= Trace_a-(8000) ! Results in below ref
150   ! level
160   MAT Trace_a_real= Trace_a_real*(.01)! now in hundredths of db
170   ! below ref lev
180   MAT Trace_a_real= Trace_a_real+(Ref_lev)
190   FOR I=1 TO 401
200     PRINT Trace_a_real(I)
210   NEXT I
220   END
```

The following programming converts binary data to volts.

```
10    ! 8546 binary data to real numbers (linear)
20    Rcvr=718
30    ASSIGN @Rcvr_bin TO Rcvr;FORMAT OFF
40    INTEGER Trace_a(1:401)
50    OUTPUT Rcvr;"LN;AUNITS V;"
60    OUTPUT Rcvr;"RL?;"
70    ENTER Rcvr;Ref_lev
80    Ref_lev_factor=Ref_lev/8000
90    OUTPUT Rcvr;"TDF B;TRA?;"
100   ENTER @Rcvr_bin;Trace_a(*)
110   ! now the instrument has all the data
120   ! to determine the measured trace data
130   REAL Trace_a_real(1:401)
140   MAT Trace_a_real= Trace_a*(Ref_lev_factor)
150   FOR I=1 TO 401
160     PRINT Trace_a_real(I)
170   NEXT I
180   END
```

A-Block Format

The A-block format is similar to binary format in that each data point is sent as two 8-bit bytes (this, too, is in the internal representation of measurement data). A-block format also transfers a four-byte header before the 401 points of trace data. These bytes are the ASCII character "#", "A", and two-byte number representing the length of the trace data, followed by the data bytes.

Example of Using the A-Block Format

This example sends trace data from the instrument to the computer and back to the instrument in A-block format.

```
10 INTEGER Tra_binary(1:401)
20 DIM Header$[4]
30 OUTPUT 718;"IP;CF 300MZ;SP 20MZ;SNGLS;TS;"
40 OUTPUT 718;"MDS W;TDF A;TRA?;"
50 ENTER 718 USING "#,4A,401(W)";Header$,Tra_binary(*)
60 PRINT "PRESS CONTINUE TO RETURN DATA TO THE INSTRUMENT"
70 PAUSE
80 OUTPUT 718;"IP;TS;VIEW TRA;"
90 OUTPUT 718;"TDF A;"
100 OUTPUT 718 USING
"#,K,W,401(W)";"TRA#A",802,Tra_binary(*),"";
110 END
```

Declare an array for trace data.

Declare a string for the #, A, MSB length, and LSB length header.

Take a measurement sweep.

Send trace A to the computer in A-block format.

The computer receives the header and the trace data.

View trace A.

The instrument receives the trace data from the computer.

The transferred trace data consists of #A, a two-byte number representing the most significant byte (MSB) length and the least significant byte (LSB) length, and the data bytes. Depending on the terminal you are using, the data bytes may appear as symbols instead of numbers. Consult your computer documentation to determine the numeric value of the data bytes.

For more detailed information about the A-block format and the MDS command, see the descriptions for TDF and MDS in Chapter 4.

I-Block Format

The I-block format transfers data points as two 8-bit bytes in the internal representation of measurement data. In addition to transferring trace data, I-block format also transfers the characters “#” and “I”. These characters indicate that the trace data is in I-block format. The I-block format allows the instrument to accept up to 401 points of trace data when using I-block format. Fewer than 401 points of trace data can be specified, and the instrument will accept data until an EOI signal is sent to it. Therefore, returning the trace data to the instrument requires an important instruction, END. (See following example.)

Example of Using the I-Block Format

This example sends trace data from the instrument to the computer and back to the instrument in I-block format.

```
10 INTEGER Tra_binary(1:401)
20 DIM Header$[2]
30 OUTPUT 718;"IP;CF 300MZ;SP 20MZ;SNGLS;TS;"
40 OUTPUT 718;"TDF I;TRA?;"
```

Declare an array for trace data.

Declare an array for #, I header.

Take a measurement sweep.

Send trace A data in I-block format.

```

50 ENTER 718 USING "#,2A,401(W)";Header$,Tra_binary(*)
60 PRINT "PRESS CONTINUE TO RETURN DATA TO THE INSTRUMENT"
70 PAUSE
80 OUTPUT 718;"IP;TS;VIEW TRA;"
90 OUTPUT 718;"TDF I;"
100 OUTPUT 718 USING "#,K,W,401(W)";"TRA#I",
Tra_binary(*)END
110 END

```

The computer receives the header and trace A data.

View trace A.

The trace data is returned to the instrument.

The END statement in line 100 sends the instrument the last data byte stored in the array and sets the HP-IB EOI line "true," as required by the I-block format.

The transferred trace data consists of #I, followed by data bytes until the EOI line is set true.

For more detailed information about the I-block format and the MDS command, see the descriptions for TDF and MDS in Chapter 4.

M Format

The M format is for sending trace data only. It formats the trace data in the internal format used by the instrument, also known as measurement units. Refer to Figure 3-1.

The displayed amplitude of each element falls on one of 8000 vertical points with 8000 equal to the reference level. For log scale data, each point is equal to 0.01 dB. The peak of the signal in Figure 3-1 is equal to 72 dB μ V for the EMI receiver (87 dB μ V for the RF filter section) or two divisions below the reference level. In measurement units, it is equal to 6000 (8000 – 2000 = 6000). In linear mode, each point has a resolution of [reference level in volts divided by 8000]. The range of internal data is –32,768 to +32,767. In practice however, the range limits can be reached during trace math operations only.

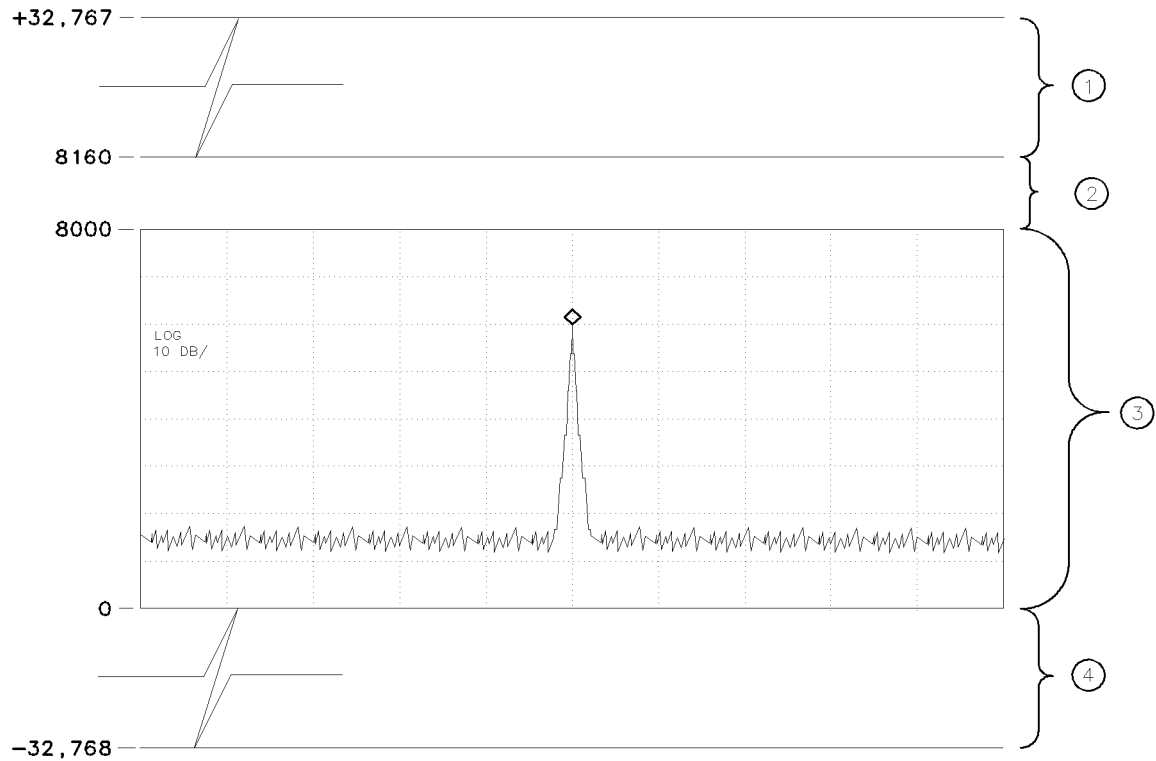

cu119e

Figure 3-1. Measurement Unit Range and Trace Amplitudes

Table 3-1. Measurement Units

Index Number	Description
1	A number within the range of 8161 to 32,767 measurement units is clipped at upper limit.
2	The area from 8000 (reference level) to 8160 (1.6 dB above reference level) represents the amount a trace element's amplitude can exceed the top graticule and still be displayed without clipping.
3	The area from 0 to 8000 represents the displayed range for trace amplitude data. The range of 0 to 8000 varies according to the amplitude scale of the instrument as follows: <ul style="list-style-type: none"> ■ In 10 dB/division, the range is from 0 to 8000. ■ In 5 dB/div, the range is from 4000 to 8000. ■ In 2 dB/div, the range is from 6000 to 8000. ■ In 1 dB/div, the range is from 7000 to 8000.
4	A number within the range of 0 to -32,768 measurement units is clipped at lower limit.

Example of Using the M Format

This example sends trace data from the instrument to the computer in M format.

```

10 INTEGER A(1:401)           Dimension array A.
30 OUTPUT 718;"IP;CF 300MZ;SP 20MZ;SNGLS;TS;" Take a measurement sweep.
40 OUTPUT 718;"TDF M;TRA?;" Send trace A data in M format.
50 ENTER 718;A(*)           The computer receives the trace data.
60 PRINT A(*)               Print trace data.
70 END

```

Note All trace math functions are done using measurement units. See Table 4-4 for a list of all trace math functions.

The result is in measurement units (−32768 to +32767).

Table 3-2 summarizes the different trace data formats.

Table 3-2. Summary of the Trace Data Formats

Trace Data Format	Description	Remarks
TDF P	Real Number Format	Instrument must be in log scale to use TDF P. To send the trace data back to the instrument, the data must be converted to measurement units.
TDF B	Binary Format	Fastest format for trace data transfers. Use the A-block format to send data back to the instrument.
TDF A	A-Block Data Format	Trace data preceded by “#,” “A,” and a two-byte number. To use the A-block format for sending data, you must provide the number of data bytes.
TDF I	I-Block Data Format	Trace data preceded by “#,” and “I.”
TDF M	Measurement Data Format	TDF M cannot be used to send trace data back to the instrument.

Programming Commands

What You'll Learn in This Chapter

This chapter is a reference for the EMI receiver and receiver RF section that lists all parameters for each of the programming commands available.

To find a programming command that performs a particular function, first refer to Table 4-4 where commands are categorized by function. Once the desired command is found in the functional index, refer to the description for the command in this chapter.

This chapter includes the reference tables listed below:

- Table 4-1, Syntax Elements
- Table 4-2, Characters and Secondary Keywords (reserved words)
- Table 4-3, Summary of Compatible Commands
- Table 4-4, Functional Index

Syntax Conventions

Command syntax is represented pictorially.

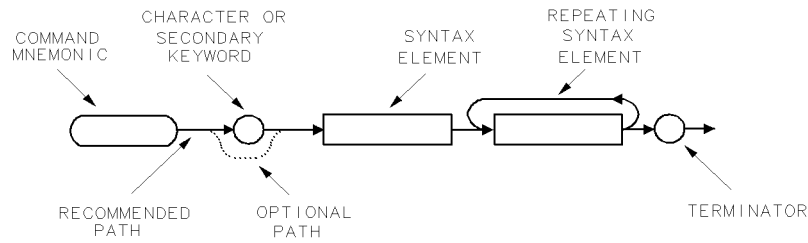

cu114e

Figure 4-1. Command Syntax Figure

- Ovals enclose command mnemonics. The command mnemonic must be entered exactly as shown.
- Circles and ovals surround secondary keywords or special numbers and characters. The characters in circles and ovals are considered reserved words and must be entered exactly as shown. See Table 4-2.
- Rectangles contain the description of a syntax element defined in Figure 4-1.
- A loop above a syntax element indicates that the syntax element can be repeated.
- Solid lines represent the recommended path.
- Dotted lines indicate an optional path for bypassing secondary keywords or using alternate units.
- Arrows and curved intersections indicate command path direction.
- Semicolons are the recommended command terminators. Using semicolons makes programs easier to read, prevents command misinterpretation, and is recommended by IEEE Standard 728.

Note Uppercase is recommended for entering all commands unless otherwise noted.

Syntax Elements are shown in the syntax diagrams as elements within rectangles.

Table 4-1. Syntax Elements

Syntax Component	Definition/Range
instrument command	Any instrument command in this chapter, with required parameters and terminators.
character	SP ! " # \$ % & ' () + , / 0 1 2 3 4 5 6 7 8 9 : ; A B C D E F G H I J K L M N O P Q R S T U V W X Y Z [\] ? _ ` a b c d e f g h i j k l m n o p q r s t u v w x y z (Characters are a subset of data byte.)
character & EOI	8-bit byte containing only character data and followed by end-or-identify (EOI) condition, where the EOI control line on HP-IB is asserted to indicate the end of the transmission. END signifies the EOI condition.
data byte	8-bit byte containing numeric or character data.
data byte & EOI	8-bit byte containing numeric or character data followed by end-or-identify (EOI) condition, where the EOI control line on HP-IB is asserted to indicate the end of the transmission. END signifies the EOI condition.
delimiter	~ \ @ = / ^ \$ % ; ! ' : " & Matching characters that mark the beginning and end of a character string, or a list of user-defined functions or instrument commands. Choose delimiting characters that are not used within the string they delimit.
digit	0 1 2 3 4 5 6 7 8 9
lsb length	Represents the least significant byte of a two-byte word that describes the number of bytes returned or transmitted. See msb length.
msb length	Represents the most significant byte of a two-byte word that describes the number of bytes returned or transmitted. See lsb length.
number	Expressed as integer, decimal, or in exponential (E) form. Real Number Range: $\pm 1.797693134862315 \times 10^{308}$, including 0. Up to 15 significant figures allowed. Numbers may be as small as $\pm 2.225073858507202 \times 10^{-308}$ Integer Number Range: -32,768 through +32,767
output termination	Carriage return (C _R) and line feed (L _F), with end-or-identify (EOI) condition. ASCII codes 13 (carriage return) and 10 (line feed) is sent via HP-IB, then the end-or-identify control line on HP-IB sets to indicate the end of the transmission.
predefined function	BITE, CNTLI, CORREK, DONE, HN, LIMIFAIL, MEAN, MEANTH, MINPOS, MKBW, PEAKS, PKPOS, PWRBW, REV, RMS, SER, STB, SUM, SUMSQR, TRCMEM, VARIANCE. A predefined function is an instrument command that returns a number that can be operated on by other instrument commands. Insert a predefined function into a command statement where predefined function appears in the command syntax chart. If a predefined function takes a parameter (for example, PKPOS TRA), it can be used only as the last parameter of a instrument command that has two or more predefined functions as parameters. For example, MPY V_AR,PKPOS TRB,HAVE DISK; is illegal, but MPY V_AR,DONE,HAVE DISK; is not.

Table 4-1. Syntax Elements (continued)

Syntax Component	Definition/Range
predefined variable	<p>The values of the following variables change depending on the current instrument settings. Each variable represents the value of the command function that has the same name as the variable.</p> <p>AMB, AMBPL, ANNOT, AT, AVBW, BAUDRATE, CF, CNTLA, CNTLB, CNTLC, CNTLD, COUPLE, DATEMODE, DET, FA, FB, FMGAIN, FOFSET, GR, GRAT, IFBW, INZ, LG, LIMIDISP, LIMIMODE, LIMIREL, LIMITEST, MEASURE, MF, MKA, MKACTION, MKF, MKFCR, MKN, MKNOISE, MKP, MKPAUSE, MKPX, ML, MKTRACK, MSI, NRL, POWERON, PREAMPG, PRNTADRS, PSTATE, RB, RL, RLPOS, ROFFSET, SETDATE, SETTIME, SP, SQLCH, SRCALC, SRCAT, SRCNORM, SRCPOFS, SRCPSTP, SRCPSWP, SRCPWR, SRCTK, SS, ST, SWPCPL, TH, TIMEDATE, TIMEDSP, VB, VBR, WINZOOM, ZMKCNTR, ZMKSPAN.</p>
trace element	<p>Value contained in one trace point. Notated as TRA[N] where N specifies the point position in the trace array. Values for N are 1 to 401 (for traces A, B, C) or 1 to 2047 (for traces specified by TRDEF). The same values apply to trace B (TRB[N]), trace C (TRC[N]), and user-defined traces (LABEL[N]).</p>
trace range	<p>Values contained in trace segment. Multi-point segments are notated as TRA[N,M], where N and M are end points of a segment and specify point positions in trace array. Values for N or M are 1 to 401 (for traces A, B, C), or 1 to the length of a trace as specified by TRDEF. The same values apply to trace B (TRB[N,M]), trace C (TRC[N,M]), and user-defined traces (LABEL[N,M]). Single-point segments are notated the same as the trace element above.</p>
units	<p>Represent standard scientific units.</p> <p>Frequency Units: GHZ or GZ, MHZ or MZ, KHZ or KZ, HZ</p> <p>Amplitude Units: DB, DM, DBMV, DBPT, DBUA, DBUV, DBUAM, DBUVM, G, PT, V, MV, UAM, UV, UVM, W, MW, UW</p> <p>Time Units: SC, MS, US</p> <p>Current Units: A, MA, UA</p> <p>Impedance Units: OHM</p>
user-defined trace	<p>A label 2 to 11 characters long that is defined by the TRDEF command. Choice of characters is A through Z and the underscore(_). The underscore should be used as the second character of the label. Omitting the underscore, or using the underscore as other than the second character in a label, is not recommended.</p>
user-defined variable	<p>A label 2 to 11 characters long that is defined by the VARDEF command. Choice of characters is A through Z and the underscore(_). The underscore should be used as the second character of the label. Omitting the underscore, or using the underscore as other than the second character in a label, is not recommended.</p>

In the syntax diagrams, characters and secondary keywords are shown within circles or ovals. Characters and secondary keywords must be entered exactly as shown.

Table 4-2. Characters and Secondary Keywords (Reserved Words)

Element	Description
A	Amp (unit) or A-block data field
ABSHZ	Absolute Hz (unit)
AC	Alternating current
ALL	All
AM	Amplitude modulation
AMP	Amplitude
AMPCOR	Amplitude correction
AUTO	Auto couple or set to automatic
AVG	Average
B	8-bit byte or binary format
BOTH	Both odd and even frames trigger
BW	Black and white
c	Cable amplitude correction factors
CNT	Counter-lock
COLOR	Color
CPL	Couple
d	Downloadable programs
DB	Decibel (unit)
DBM	Absolute decibel milliwatt (unit)
DBMV	Decibel millivolt (unit)
DBUV	Decibel microvolt (unit)
DC	Direct current
DELTA	Delta
DISP	Display
DM	Absolute decibel milliwatt (unit)
DMY	Day, month, year format
DN	Decreases parameter one step size
DUMP	Dump
e	Set up file
EDGE	Triggers on the edge of the trigger input
EP	Pauses program for data entry from instrument front panel
EQ	Equal to
EVEN	Even video frame
EXT	External trigger
FADC	Fast analog-to-digital converter (ADC)
FETCH	Fetch
FFT	Fast Fourier transform
FIXED	Fixed
FLAT	Flat
FLATTOP	Flat top filter window
FMD	Frequency modulation demodulator

**Table 4-2.
Characters and Secondary Keywords (Reserved Words) (continued)**

Element	Description
FM	Frequency modulation
FMV	Frequency modulation detection
FREE	Free run
FREQ or FRQ	Frequency
g	Signal list file
G	Gauss
GE	Greater than or equal to
GHZ	Gigahertz (unit)
GT	Greater than
GZ	Gigahertz (unit)
HANNING	Hanning filter window
HI	Highest
HPIB	HP-IB
HZ	Hertz (unit)
I	I-block data field
i	Display image file
INIT	Initialize
INT	Internal or integer
IP	Instrument preset
IST	Inverse sweep time
K	Free field ASCII format with no terminator
KC	Free field ASCII format with "CR" an "LF" terminator
KHZ	Kilohertz (unit)
KL	Free field ASCII format with "CR" an "END" terminator
KZ	Kilohertz (unit)
l	Limit line file
LAST	Last state
LE	Less than or equal to
LEVEL	Level gating
LIMILINE	Limit line
LINE	Line trigger
LOAD15	Loads the values for the horizontal and vertical position of the instrument
LOWER	Lower limit line
LT	Less than
M	Measurement units
MA	Milliamp (unit)
MDY	Month, day, year format
MHZ	Megahertz (unit)
MS	Millisecond (unit)
MTR	Meter
MV	Millivolts (unit)
MW	Milliwatt (unit)
MZ	Megahertz (unit)
n	Antenna amplitude correction factors
NE	Not equal to
NEG	Negative
NH	Next highest peak
NL	Next peak left

**Table 4-2.
Characters and Secondary Keywords (Reserved Words) (continued)**

Element	Description
NONE	No units
NR	Next peak right
NRM or NORMAL	Normal
o	Other amplitude correction factors
OA	Output amplitude
ODD	Odd video frame trigger
OFF	Turns off function
ON	Turns on function
P	Parameter units
PER	Period
PKAVG	Peak average
PKPIT	Peak pit
POINT	Point
POS	Positive
PSN	Position
PT	pico Tesla
RECALL	Recall operation
RS232	RS-232 interface
s	State file
SA	Signal analysis
SAVE	Save operation
SC	Seconds (unit)
SLOPE	Slope
SMP	Sample detection mode
SP	Space
SR	Stimulus response
STATE	State register
STEP	Step key ability
STORE	Store
SWT	Sweep time
t	Trace file
TG	Tracking generator
TRA	Trace A
TRB	Trace B
TRC	Trace C
UA	Microamp (unit)
UAM	Microamps per meter
UNCPL	Uncouple
UNIFORM	Uniform filter window
UP	Increases the parameter one step size
UPLOW	Upper and lower limit lines
UPPER	Upper limit line
US	Microseconds (unit)
UV	Microvolts (unit)
UVM	Microvolts per meter
UW	Microwatt (unit)

**Table 4-2.
Characters and Secondary Keywords (Reserved Words) (continued)**

Element	Description
V	Volts (unit)
VERTICAL	Vertical triggering
VID	Video trigger
W	Watts or word (for MDS command)
YTF	YIG-tuned filter
XTAL	Crystal
*	Asterisk (used as a wildcard)
;	Semicolon (ASCII code 59)
,	Comma (ASCII code 44)
0	Off (command argument)
1	On (command argument)
50	50Ω
75	75Ω
?	Returns a query response containing the value or state of the associated parameter. The query response is followed by a carriage-return/line-feed.

The alternate commands (listed in the left column of Table 4-3) provide compatibility with commands used by the HP 8566A/B, HP 8568A/B, and HP 70000 Series instruments. The equivalent commands for the HP 8542E/HP 8546A EMI receiver or HP 85422E/HP 85462A receiver RF section are listed in the right column.

Table 4-3. Summary of Compatible Commands

Alternate Commands	Description	HP 8546A/HP 8542E Command
A1	Clear write trace A	CLRW TRA
A2	Max hold trace A	MXMH TRA
A3	Store and view trace A	VIEW TRA
A4	Store and blank trace A	BLANK TRA
B1	Clear write trace B	CLRW TRB
B2	Max hold trace B	MXMH TRB
B3	Store and view trace B	VIEW TRB
B4	Store and blank trace B	BLANK TRB
C1	Trace A minus trace B off	AMB OFF
C2	Trace A minus trace B on	AMB ON
CA	Coupled input attenuation	AT AUTO
CR	Coupled resolution bandwidth	IFBW AUTO
CS	Coupled step size	SS AUTO
CT	Coupled sweep time	ST AUTO
CV	Coupled video bandwidth	AVBW AUTO
E1	Peak search	MKPK HI
E2	Enter marker into center frequency	MKCF
E3	Enter marker delta into center frequency step size	MKSS
E4	Enter marker amplitude into reference level	MKRL
EX	Exchange trace A and B	AXB
KSA	dBm amplitude units	AUNITS DBM
KSB	dBmV amplitude units	AUNITS DBMV
KSC	dB μ V amplitude units	AUNITS DBUV
KSD	Volt amplitude units	AUNITS V
KSE	Screen title	TITLE
KSG	Video average on	VAVG ON
KSH	Video average off	VAVG OFF
KSM	Marker noise	MKNOISE
KSO	Marker value to span	MKSP
KSZ	Reference level offset	ROFFSET
KSc	Trace A plus trace B into trace A	APB
KSi	Exchange trace B and C	BXC
KSl	Trace B into trace C	BTC
KSm	Graticule off	GRAT OFF
KSn	Graticule on	GRAT ON
KSo	Annotation off	ANNOT OFF
KSp	Annotation on	ANNOT ON
L0	Display line off	DL OFF

Table 4-3. Summary of Compatible Commands (continued)

Alternate Commands	Description	HP 8546A/HP 8542E Command
M1	Marker off	MKOFF
M2	Marker normal	MKN
M3	Marker delta	MKD
MA	Marker amplitude	MKA?
MC	Marker count	MKFC
MT0	Marker track off	MKTRACK OFF
MT1	Marker track on	MKTRACK ON
O1	Output format, in real number format	TDF P
O2	Output format, in binary format, two bytes (word) per element	TDF B;MDS W
O3	Output format, in measurement data format	TDF M
O4	Output format, in binary format, 1 byte per element	TDF B;MDS B
R1	Activates illegal command service request only	RQS 32
R2	Activates end-of-sweep, illegal command	RQS 36
R3	Activates broken hardware, illegal command	RQS 40
R4	Activates units-key pressed, illegal command	RQS 34
RC	Recall state	RCLS
S1	Sweep continuous	CONTS
S2	Sweep single	SNGLS
SV	Save state	SAVES
T0	Threshold off	TH OFF
T1	Trigger mode free run	TM FREE
T2	Trigger mode line	TM LINE
T3	Trigger mode external	TM EXT
T4	Trigger mode video	TM VID

This functional index categorizes the programming commands by the type of function that the command performs. The functional index contains the following information: the programming command mnemonic, the softkey or front-panel key that corresponds to the command's function, and a brief definition of the command. Once the desired command is found, refer to the alphabetical listing of commands later in this chapter for more information about the command.

Table 4-4. Functional Index

Function Category	Command	Corresponding Key Function	Description
AMPLITUDE	ARNG	AUTO RANGE	Turns the autorange function on or off.
	AT	ATTEN AUTO MAN	Specifies RF input attenuation.
	AUNITS	Amptd Units	Specifies amplitude units for input, output, and display.
	COUPLE	COUPLE AC DC	Selects direct-current (dc) coupling or alternating-current (ac) coupling.
	INZ	INPUT Z 50Ω 75Ω	Specifies the value of input impedance expected at the active input port.
	LG	SCALE LOG LIN (when LOG is underlined)	Specifies the vertical graticule divisions as logarithmic units, without changing the reference level.
	LN	SCALE LOG LIN (when LIN is underlined)	Specifies the vertical graticule divisions as linear units, without changing the reference level.
	ML	MAX MXR LVL	Specifies the maximum signal level that is applied to the input mixer for a signal that is equal to or below the reference level.
	NRL		Sets the normalized reference level.
	OVLN	OVLN ON OFF	Enables or disables overload detection.
	PREAMP	PREAMP ON OFF	Switches the system preamplifier in and out of the input path.
	PREAMPG	EXTERNAL PREAMPG	Subtracts a positive or negative preamplifier gain value from the displayed signal.
	PP ¹	PRESEL PEAK	Performs a preselector peak.
	RANGE		Puts highest signal on display close to the reference level.
	RESETRL		Resets the reference level to its instrument preset level.
	RL	REF LVL	Specifies the amplitude value of the reference level.
	ROFFSET	REF LVL OFFSET	Offsets all amplitude readouts without affecting the trace.
UNRANGE		Restores reference level to the value set prior to RANGE command.	
XUNITS	Edit Antenna functions	Selects the transducer conversion units for the AMPCOR correction factors.	
AUTO COUPLING	AUTO	AUTO ALL	Couples the active functions automatically.

¹ For an HP 8546A/HP 85462A only.

Table 4-4. Functional Index (continued)

Function Category	Command	Corresponding Key Function	Description
AUXILIARY CONTROL	BYPASS ¹	INPUT 2 BYPASS	Switches in and out of the bypass input path.
	CALSW	VIEW CAL ON OFF	Switches the 300 MHz calibrator signal.
	CNTLA ²	CNTL A 0 1	Sets the control line A of the auxiliary interface high or low.
	CNTLB ²	CNTL B 0 1	Sets the control line B of the auxiliary interface high or low.
	CNTLC ²	CNTL C 0 1	Sets the interface control line C of the auxiliary interface high or low.
	CNTLD ²	CNTL D 0 1	Sets the interface control line D of the auxiliary interface high or low.
	CNTLI	DISPLAY CNTL I	Returns a "1" when the interface control line I of the auxiliary interface is high, and "0" if the line is low.
	DEMODO	DEMODO ON OFF , DEMODO AM FM	Turns the demodulator on or off, and selects between AM, FM, or quasi-peak demodulation.
	FMGAIN	FM GAIN	Sets the total FM frequency deviation for full screen demodulation.
	MEASURE		Determines the type of measurement: signal analysis, stimulus response, or signal normalization.
	NRL		Sets the normalized reference level.
	RFIN ¹	INPUT	Specifies signal path through the RF filter section.
	RFINLK ¹	INPT LCK ON OFF	Enables or disables tuning limits based on RF filter section input.
	RLPOS		Selects the position of reference level.
	SPEAKER	SPEAKER ON OFF	Turns on or off the internal speaker.
	SQLCH	SQUELCH	Sets the squelch level.
	SRCALC	ALC INT EXT	Selects internal or external leveling for the tracking generator.
	SRCAT	SRC ATN MAN AUTO	Attenuates the source output level.
	SRCNORM		Subtracts trace B from trace A, adds the display line, and sends the result to trace A.
	SRCPOFS	SRC PWR OFFSET	Offsets the source power level readout.
	SRCPSTP	SRC PWR STP SIZE	Selects the source-power step size.
	SRCPSWP	PWR SWP ON OFF	Selects sweep range of the source output.
	SRCPWR	SRC PWR ON OFF	Selects the source power level.
SRCTK	MAN TRK ADJUST	Adjusts tracking of source output with instrument sweep.	
SRCTKPK	TRACKING PEAK	Adjusts tracking of source output with instrument sweep.	
SWPCPL	SWP CPLG SR RECV	Selects a stimulus-response (SR) or receiver (RCVR) auto-coupled sweep time.	

1 Accessible if the HP 85460A/HP 85420E RF filter section is present.

2 Not accessible if the HP 85460A/HP 85420E RF filter section is present.

Table 4-4. Functional Index (continued)

Function Category	Command	Corresponding Key Function	Description
BANDWIDTH	AVBW	AVG BW AUTO MAN	Specifies the video bandwidth.
	IFBW	IF BW AUTO MAN , 200 Hz EMI BW , 9 kHz EMI BW , 120 kHz EMI BW	Specifies the resolution bandwidth.
	VAVG	VID AVG ON OFF	Turns on or off video averaging.
	VBR	AV/IF BW RATIO	Specifies coupling ratio of video bandwidth to resolution bandwidth.
CALIBRATION	AMPCOR	Amp Cor functions	Applies amplitude corrections at specified frequencies.
	AMPLN		Returns the number of frequency-amplitude correction factors that have been entered.
	CAL CORREK	(CALIBRATE) functions	Initiates self-calibration routines. Returns a "1" if the correction factors are on, a "0" if they are off.
COMMAND TRIGGER	WAIT		Suspends all instrument operation for the specified time duration.
CONFIGURATION	BAUDRATE	BAUD RATE	Specifies the baud rate of a instrument.
	CAT	Catalog Internal , CATALOG DISK	Returns the catalog information of either internal memory or the floppy disk.
	DATEMODE	DATEMODE MDY DMY	Allows you to set the format for displaying the real-time clock.
	DISPOSE	DISPOSE USER KEY	Frees instrument memory that was previously allocated for user-defined operands.
	FORMAT	FORMAT DOS DISK , FORMAT LIF DISK	Formats the floppy disk.
	LINCHK	(LINEARITY CHECK)	Determines whether a measured signal is undergoing compression.
	POWERON	POWER ON IP LAST	Selects the instrument's power on state.
	PREFIX	Change Prefix	Specifies or changes the prefix used in save and recall operations.
	SETDATE	SET DATE	Sets the date of the real-time clock.
	SETTIME	SET TIME	Sets the time of the real-time clock.
	TIMEDATE	Time Date	Sets the time and date of the real-time clock.
	TIMEDSP	TIMEDATE ON OFF	Turns on or off the display of the real-time clock.

Table 4-4. Functional Index (continued)

Function Category	Command	Corresponding Key Function	Description
DISPLAY	ANNOT	ANNOTATN ON OFF	Turns on or off the screen annotation.
	GRAT	GRAT ON OFF	Turns on or off the graticule.
	HD	HOLD	Disables data entry via the instrument numeric keypad, knob, or step keys. The active function readout is blanked, and any active function is deactivated.
	LASTKEYMENU	LAST HRD KEY MENU	Changes the menu to the last hardkey menu that was active.
	PREFIX	Change Prefix	Specifies the prefix.
	RCLC	RECALL COLORS	Recalls previously displayed colors.
	SAVEC	SAVE COLORS	Saves currently displayed colors.
	SETC	Adjust Color functions	Displays the sub-systems color editor.
	TH	THRESHLD ON OFF	Clips signal responses below the threshold level.
	SHOWSETUP	SHOW SETUP	Shows the setup on the display.
	TITLE	Change Title	Activates the screen title mode.
	UDKDEFINE	DEFINE USER KEY	Redefines a user-defined key.
	UDKSET	DEFINE USER KEY	Changes the definition of the user-defined key.
EMI MEASUREMENTS	AUTOAVG	DETECTOR PK QP AV	Turns on and off the automatic measuring of the average detector.
	AUTOQPD	DETECTOR PK QP AV	Turns on and off the automatic measuring of the quasi-peak detector.
	MEASALLSIGS	AUTO-MEASURE	Finds all signals on or above the display, then makes an EMI measurement.
	MEASAVG		Makes a measurement with peak and average detectors.
	MEASFREQ		Makes a measurement at the specified frequency.
	MEASPEAK		Makes a measurement using the peak detector.
	MEASQPD		Makes a measurement using the quasi-peak detector.
	MEASRESULT		Sends the results of the last EMI measurement to the controller.
	MEASSIG	MEASURE AT MKR	Makes a measurement using specified detectors.
	MEASTIMEAVG	AV DWELL TIME	Sets the average detector measurement time.
	MEASTIMEPK	PK DWELL TIME	Sets the peak detector measurement time.
	MEASTIMEQPD	QP DWELL TIME	Sets the quasi-peak detector measurement time.
	MEASWITHPP		Automatically peaks the preselector before making an EMI measurement.
	REMEASSIG	Re-measure functions	Remeasures one or more signals in the signal list.

Table 4-4. Functional Index (continued)

Function Category	Command	Corresponding Key Function	Description
EMI OUTPUT	RPTDEF	Define Report	Specifies which report elements are output to a printer or plotter.
	TBLDEF	Define List functions	Specifies which elements of a table are output to the printer.
FREQUENCY	CF	CENTER FREQ	Specifies center frequency.
	FA	START FREQ	Specifies the start frequency.
	FB	STOP FREQ	Specifies the stop frequency.
	FOFFSET	FREQ OFFSET	Specifies the frequency offset for all absolute frequency readouts such as center frequency.
	LOGSWEEPSPD	LOGF SPD STD FAST	Optimizes the frequency accuracy (standard) or minimizes the scan time (fast) when the LOG frequency sweep type is activated.
	SS SWEEPTYPE	CF STEP AUTO MAN SWEEP LOG LIN	Specifies center-frequency step size. Selects either logarithmic or linear frequency axis.
GRAPHICS	PRINT PRNTADRS	COPY to a printer PRINTER ADDRESS	Prints screen data. Allows you to set the HP-IB address of the printer.
	PRNTPPG	PRM/PG 1 2	Specifies number of prints per page for printing.
	PRNTRES	RESOLUTN LOW HIGH	Sets the resolution of subsequent prints.
	PRNTTYPE	Printer Type	Specifies which printer is connected to the output port.
INFORMATION	BIT		Places the state of a bit in the destination.
	BITF		Returns the state of a bit.
	CLS		Clears all status bits.
	FCALDATE		Returns the date of the last calibration performed on the system.
	FSER		Returns the serial number of the RF filter section.
	HAVE	SHOW INST CONFIG	Returns a "0" if a device or option is not installed.
	ID	SHOW INST CONFIG	Returns the instrument model number.
	MDU		Returns values for the instrument's baseline and reference level.
	PWRUPTIME		Returns the number of milliseconds that have elapsed since the instrument was turned on.
	REV	SHOW INST CONFIG	Returns the date code of the firmware revision number in YYMMDD format.
	RQS		Sets a bit mask for service requests.
SER	SHOW INST CONFIG	Returns the serial number suffix of the instrument.	
SRQ		Used by an external controller to simulate interrupts from the instrument.	

Table 4-4. Functional Index (continued)

Function Category	Command	Corresponding Key Function	Description
INPUT and OUTPUT	EK		Allows data entry with the front-panel knob when the instrument is under remote control.
	EP		Sends values entered on the instrument number keyboard to the present active function value.
	OA		Returns the value of the active function.
	OL		Transmits information to the controller that describes the state of the instrument when the OL command is executed.
	TA		Returns trace A amplitude values from the instrument to the controller.
	TB		Transfers trace B amplitude values from the instrument to the controller.
	TDF		Formats trace information for return to the controller.
	TRA TRB TRC		Controls trace data input or output.
LIMIT LINES	LIMIAMPSC	AMPL SCL LOG LIN	Specifies the limit-line amplitude definition as logarithmic or linear.
	LIMIDEL	DELETE LIMIT PURGE LIMITS ¹	Deletes all segments in the current limit-line table.
	LIMIDISP	LMT DISP Y N AUTO ¹	Controls when the limit line (or limit lines) are displayed.
	LIMIFAIL	LMT TEST ON OFF	Returns a "0" if the last measurement sweep of trace A is equal to or within the limit-line bounds.
	LIMIFRQSCL	FREQ SCL LOG LIN	Specifies the limit-line frequency axis definition as logarithmic or linear.
	LIMIFT	LIMITS FRQ TIME ¹	Selects how the limit-line segments are placed on the display: according to frequency, or according to the sweep time setting of the instrument.
	LIMIHI		Allows you to specify a fixed trace as the upper limit line.
	LIMILINE		Outputs the current limit-line table definitions.
	LIMILINESTA	LIMIT 1 ON OFF, LIMIT 2 ON OFF	Displays the selected limit line.
	LIMILO		Allows you to specify a fixed trace as the lower limit line.
	LIMIMARGAMP	MARGIN 1 ON OFF, MARGIN 2 ON OFF	Sets the amplitude in negative dB for the limit margin.
	LIMIMARGSTA	MARGIN 1 ON OFF, MARGIN 2 ON OFF	Displays the selected limit margin.
	LIMIMIRROR		Reflects the current definition about the amplitude axis at the largest frequency or the largest sweep time in the definition.

¹ Signal analysis mode only.

Table 4-4. Functional Index (continued)

Function Category	Command	Corresponding Key Function	Description
LIMIT LINES (continued)	LIMIMODE	Edit Upper ¹ , Edit Lower ¹ , Edit Up/Low ¹ , Edit Mid/Delt ¹	Determines whether the limit-line entries are treated as upper amplitude values, lower amplitude values, upper and lower amplitude values, or mid-amplitude and delta values.
	LIMINUM	LIMIT 1, LIMIT 2	Selects limit-line number 1 or 2 and its corresponding margin.
	LIMIREL	LIMITS FIX REL ¹	Specifies the current limit lines as fixed or relative.
	LIMISEG	Edit Upper, Edit Lower	Adds new segments to the current frequency limit line in either the upper limit line or the lower limit line.
	LIMISEGT	Edit Upper ¹ , Edit Lower ¹	Adds new segments to the current sweep time limit line in either the upper limit line or the lower limit line.
	LIMITEST	LMT TEST ON OFF	Compares trace A with the current limit-line data.
	SEGDEL	DELETE SEGMENT	Deletes the specified segment from the limit-line tables.
	SENER	Edit Up/Low ¹ , Edit Mid/Delt ¹	Enters the limit-line data in either the upper and lower limit-line tables or the mid and delta table for limit lines based on frequency.
	SENTERT	Edit Up/Low ¹ , Edit Mid/Delt ¹	Enters the limit-line data in either the upper and lower limit-line table or the mid and delta table for limit lines based on sweep time.
MARKER	FASTMRKR	MARKER SLO FAST	Increases the range of the marker functionality.
	MDS		Specifies measurement data size as byte or word.
	MF		Returns the frequency (or time) of the on-screen active marker.
	MKA	MARKER AMPTD	Specifies amplitude of the active marker.
	MKACT	SELECT 1 2 3 4	Specifies the active marker.
	MKACTV	MARKER 1 ON OFF	Makes the current active marker the active function.
	MKBW		Returns the bandwidth at the specified power level relative to an on-screen marker (if present) or the signal peak (if no on-screen marker is present).
	MKCF	MARKER -> CF	Sets the center frequency equal to the marker frequency and moves the marker to the center of the screen.
	MKCONT		Resumes the sweep after execution of a MKSTOP command.
	MKD	MARKER Δ	Activates the delta marker.
	MKDLMODE		Selects if the marker amplitude values are shown as relative to the reference level or relative to the display line.
	MKF		Specifies the frequency value of the active marker.

¹ Signal analysis mode only.

Table 4-4. Functional Index (continued)

Function Category	Command	Corresponding Key Function	Description
MARKER (continued)	MKFC	MK COUNT ON OFF	Turns on or off marker frequency counter.
	MKFCR	CNT RES AUTO MAN	Sets the resolution of the marker frequency counter.
	MKMIN	MARKER -> MINIMUM	Moves active marker to minimum signal detected.
	MKN	MARKER NORMAL	Activates and moves the marker to the specified frequency.
	MKNOISE	MK NOISE ON OFF	Displays the average noise level at the marker.
	MKOFF	MARKER ALL OFF	Turns off either the active marker or all the markers.
	MKP		Places the active marker at the given <i>x</i> -coordinate.
	MKPAUSE	MK PAUSE ON OFF	Pauses the sweep at the active marker for the duration of the delay period.
	MKPK	PEAK SEARCH , NEXT PEAK , NEXT PK RIGHT , NEXT PK LEFT , MARKER ->PK-PK	Positions the active marker on a signal peak.
	MKPX	PEAK EXCURSN	Specifies the minimum signal excursion for the instrument's internal peak-identification routine.
	MKREAD	MK READ F T I P	Selects the type of active trace information displayed by the instrument marker readout.
	MKRL	MARKER -> REF LVL	Sets the reference level to the amplitude value of the active marker.
	MKSP	MARKER Δ SPAN	Sets the start and stop frequencies to the values of the delta markers.
	MKSS	MARKER -> CF STEP	Sets the center-frequency step-size to the marker frequency.
	MKSTOP		Stops the sweep at the active marker.
	MKTRACE	MK TRACE AUTO ABC	Moves the active marker to a corresponding position in trace A, trace B, or trace C.
	MKTRACK	MK TRACK ON OFF	Moves the signal with an active marker to the center of the display and keeps the signal peak at center screen.
	MKTYPE		Changes the type of the current active marker.
	M4		Activates a single marker on the trace and enables the knob to change the position of the marker. The active function is then set to span.
	RCVMRKR	MARKER TUNE SPN	Modifies the behavior of the instrument's marker functionality.

Table 4-4. Functional Index (continued)

Function Category	Command	Corresponding Key Function	Description
MATH (see also Trace Math)	ABS		Places the absolute value of the source values in the destination.
	ADD		Adds the sources and sends the sum to the destination.
	AVG		Averages the source and the destination.
	BIT		Returns the state of a bit.
	CTA		Converts the source values from measurement units to the current absolute amplitude units and stores the result in the destination.
	CTM		Converts the source values to measurement units and places the result in the destination.
	DIV		Divides source 1 by source 2 and places the result in the destination.
	EXP		Places the exponential of the source in the destination.
	INT		Places the greatest integer that is less than or equal to the source value into the destination.
	LOG		Takes the logarithm (base 10) of the source, multiplies the result by the scaling factor, then stores it in the destination.
	MEAN		Returns the mean value of the given trace in measurement units.
	MEANTH		Returns the mean value of the given trace above the threshold, in measurement units.
	MIN		Compares source 1 and 2, point by point, and stores the lesser of the two in the destination.
	MINPOS		Returns a value, which is the <i>x</i> -axis position (in display units) of the minimum amplitude value in trace A, trace B, trace C, or user-defined trace.
	MOD		Stores the remainder from the division of source 1 by source 2 in the destination.
	MPY		Multiplies the sources, point by point, and places the results in the destination.
	MXM		Compares source 1 and source 2, point by point, sending the greater value of each comparison to the destination.
	PDA		Sums the probability distribution of amplitude in the destination trace with the amplitude distribution function of the source trace.
	RMS		Returns root mean square value of trace in measurement units.
SQR		Places the square root of the source into the destination.	
SUB		Subtracts source 2 from source 1, point by point, and sends the difference to the destination.	
VARIANCE		Returns the amplitude variance of the specified trace, in measurement units.	

Table 4-4. Functional Index (continued)

Function Category	Command	Corresponding Key Function	Description
MEASURE/USER	FFT		Performs a discrete fast Fourier transform on the source trace array and stores the result in the destination array.
OPERATOR ENTRY	DN EK EP HD UP	⏴ HOLD ⏵	Reduces the active function by the applicable step size. Enables front-panel knob control. Enter parameter from front panel. Holds or disables entry and blanks active function readout. Increases the active function by the applicable step size.
PLOTTER	PLOT	COPY (to a plotter)	Initiates output of the instrument display to a plotter.
PRESET	IP LF POWERON RESETRL	PRESET POWER ON IP LAST	Performs an instrument preset. Performs an instrument preset to the base band (band 0). Selects the state the instrument will be in when it is turned on: IP (instrument preset) or LAST state. Resets the reference level to instrument preset value.
PRINTER	PRINT PRNTADRS PRNTPPG PRNTRES PRNTTYPE	COPY (to a printer) PRINTER ADDRESS PRN/PG 1 2 RESOLUTN LOW HIGH Printer Type	Initiates output of the display to a printer. Sets the HP-IB address of the printer. Specifies number of prints per page for printing. Sets the resolution of subsequent prints. Specifies which printer is connected to the output port.
PROGRAM FLOW	IF REPEAT WAIT		IF/THEN/ELSE/ENDIF forms a decision and branching construct. REPEAT/UNTIL forms a looping construct. Suspends all instrument operation for the specified time duration.
RECALL or SAVE	CAT LOAD MSI PREFIX PROTECT	Catalog Internal, CATALOG DISK LOAD FILE Change Prefix PROTECT ON OFF	Displays directory information from either the specified or the current mass storage device. Loads a file from the disk. Allows you to specify the current mass storage device as the internal memory or a disk. Specifies the prefix. Prevents overwriting an existing file.

Table 4-4. Functional Index (continued)

Function Category	Command	Corresponding Key Function	Description
RECALL or SAVE	PSTATE	SAV LOCK ON OFF	Protects all of the instrument user state and trace registers from being changed.
	PURGE	DELETE FILE	Deletes the specified file from the current mass storage device.
	RCLS	INTERNAL -> STATE	Recalls instrument state data from one of the nine state registers in internal memory.
	RCLT	Internal -> Trace functions	Recalls previously saved trace data, amplitude factors, or limit-line data from the trace registers in internal memory.
	SAVES	STATE -> INTRNL	Saves the currently displayed instrument state in internal memory.
	SAVET	Trace -> Intrnl functions	Saves the selected trace data and state information, amplitude correction factors, or a save or recall operation.
	STOR	Save -> Disk functions	Stores data on a floppy disk .
SIGNAL LIST	EDITANNOT	EDIT ANNOTATN	Enters the annotation editor.
	EXITANNOT	EXIT EDIT	Exits the annotation editor.
	REMEASSIG	Re-measure functions	Remeasures one or more signals in the signal list.
	SIGADD	ADD TO LIST	Adds a signal to internal signal list.
	SIGDEL	Delete Signals functions	Deletes one or more signals from the signal list.
	SIGDLTVIEW	VIEW Δ OFF functions	Selects which delta is viewed on the display signal list.
	SIGGRAPH	SAVE LOG GRAPH , SAVE LIN GRAPH	Draws an EMI report graph on display.
	SIGLEN		Queries current number of signals in the signal list.
	SIGLIST	SIG LIST ON OFF	Turns on or off signal list viewing and editing functions.
	SIGMARK	Signal Marking functions	Marks one or more signals on the signal list.
	SIGPOS	SELECT FRM LIST	Controls the cursor position in the signal list.
	SIGRESULT		Sends contents of an entry in the signal list to the controller.
	SIGSORT	Sort Signals functions	Sorts internal signal list.
	SIGUNMARK	CLEAR MARK , CLR ALL MARKS	Unmarks one or more signals on the signal list.

Table 4-4. Functional Index (continued)

Function Category	Command	Corresponding Key Function	Description
SPAN	FS	FULL SPAN	Sets the frequency span of the instrument to full span.
	HN		Returns the harmonic number of the current harmonic band in which the instrument is tuning.
	HNLOCK ¹	Band Lock functions	Forces the instrument to use only the selected harmonic band.
	HNUNLK ¹	<u>BND LOCK ON OFF</u> (OFF is underlined)	Unlocks the harmonic band.
	LSPAN	LAST SPAN	Changes the instrument's span to the previous span setting.
	SP	SPAN	Changes the total displayed frequency range symmetrically about the center frequency.
	SPZOOM	SPAN ZOOM	Places a marker on the highest on-screen signal (if an on-screen marker is not present), turns on the signal track function, and activates the span function.
SWEEP	CONTS	<u>SWEEP CONT SGL</u> (CONT is underlined)	Sets the instrument to the continuous sweep mode.
	LOGSWEEPSPD	LOGF SPD STD FAST	Optimizes the frequency accuracy (standard) or minimizes the scan time (fast) when the LOG frequency sweep type is activated.
	ST	SWP TIME AUTO MAN	Specifies the time in which the instrument sweeps the displayed frequency range.
	SWEEPTYPE	SWEEP LOG LIN	Selects either logarithmic or linear frequency axis.
SYNCHRONIZATION	DONE		Allows you to determine when the instrument has started to execute all commands prior to and including DONE.
	TS		Starts and completes one full sweep before the next command is executed.
TRACE MATH	AMB	A - B -> A ON OFF	Subtracts trace B from trace A and sends the result to trace A during every sweep of the instrument.
	AMBPL	NORMLIZE ON OFF	Subtracts trace B from trace A, adds the display line value to the difference, and sends the result to trace A during every sweep of the instrument.
	AXB	A <--> B	Exchanges trace A and trace B.
	BLANK	BLANK A , BLANK B , BLANK C	Blanks trace A, trace B, or trace C and stops taking new data into the specified trace.
	BML	B - DL -> B	Subtracts display line from trace B and places the result in trace B.
	BTC	B -> C	Transfers trace B into trace C.
	BXC	B <--> C	Exchanges trace B and trace C.

¹ For an HP 8546A/HP 85462A only.

Table 4-4. Functional Index (continued)

Function Category	Command	Corresponding Key Function	Description
TRACE MATH (continued)	CLRW	CLEAR WRITE A , CLEAR WRITE B , CLEAR WRITE C	Clears the specified trace and enables trace data acquisition.
	DET	DETECTOR SMP PK	Selects the instrument detection mode.
	IB		Provides a method for putting values into trace B.
	MERGE		Merges the source trace into the specified area of the destination trace.
	MINH	MIN HOLD C	Updates trace C elements with minimum level detected.
	MOV		Copies the source values into the destination.
	MXMH	MAX HOLD A , MAX HOLD B	Updates trace elements with maximum level detected.
	TA		Returns trace A data.
	TB		Returns trace B data.
	TRA TRB TRC		Controls trace data input and output.
	TRCMEM		Returns a nonnegative integer that indicates the total number of trace registers available for SAVET and RCLT.
	TRDSP		Turns on or off the display of trace A, B, or C without clearing the trace (measurements can still be taken).
	TRPRST		Sets the trace operations to their preset values.
	TRSTAT		Returns the status of traces A, B, and C: clear write, blank, view, minimum hold, or maximum hold.
	TWNWOW		Creates a window trace array for the fast Fourier transform (FFT) function.
	VAVG	VID AVG ON OFF	Enables the video-averaging function, which averages trace points to smooth the displayed trace.
	VIEW	VIEW A , VIEW B , VIEW C	Displays trace A, trace B, or trace C, and stops taking new data into the viewed trace.
	APB		Adds trace A to trace B and sends the result to trace A.
	CLRAVG	VID AVG ON OFF	Restarts video averaging.
	COMPRESS		Reduces the number of trace elements while retaining the relative frequency and amplitude characteristics of the trace data.
CONCAT		Combines two traces.	
FFT		Calculates fast Fourier transform.	
LINFILL		Fills linear interpolated data into the specified trace data points of a destination trace.	

Table 4-4. Functional Index (continued)

Function Category	Command	Corresponding Key Function	Description
TRACE MATH (continued)	MIRROR		Displays the mirror image of a trace.
	PEAKS		Sorts signal peaks by frequency or amplitude, stores the results in the destination trace, and returns the number of peaks found.
	SMOOTH		Smooths the trace according to the number of points specified for the running average.
	SUM		Returns the sum of the amplitudes of the trace elements in measurement units.
	SUMSQR		Returns the sum of the squares of the amplitude of each trace element.
	XCH		Exchanges traces.
TRIGGER	SNGLS	(SINGLE) , SWEEP CONT SGL (SGL is underlined)	Selects single-sweep mode.
	TM	FREE RUN, LINE, VIDEO, EXTERNAL	Specifies trigger mode.
	TS		Begins a new sweep.
USER-DEFINED	DISPOSE	DISPOSE USER KEY	Deletes user-defined functions.
	ERASE		Clears trace A and trace B, disposes of the contents of the user memory, and resets the state registers and the instrument to the instrument preset state.
	TRDEF		Declares a user-defined trace.
	UDKDEFINE	DEFINE USER KEY	Redefines a user-defined key.
	UDKSET	DEFINE USER KEY	Changes the definition of the user-defined key.
	VARDEF		Creates a user-defined variable and assigns it a value.
WINDOWS	WINNEXT	(NEXT)	Makes the window that is currently not the active window, active.
	WINOFF	WINDOWS OFF	Turns off the windows display.
	WINON	(ON)	Activates the windows display mode.
	WINZOOM	(ZOOM)	Expands the size of the active window so that it fills the entire display.
	ZMKCNTR	ZONE CENTER	Positions the zone marker at the specified frequency.
	ZMKPNL	ZONE PK LEFT	Places the zone marker at the next signal peak that is left of the zone marker's current position.
	ZMKPNR	ZONE PK RIGHT	Places the zone marker at the next peak to the right of the zone marker's current position.
	ZMKSPAN	ZONE SPAN	Allows you to change the width of the zone marker.

ABS Absolute

Places the absolute value of the source values in the destination.

Syntax

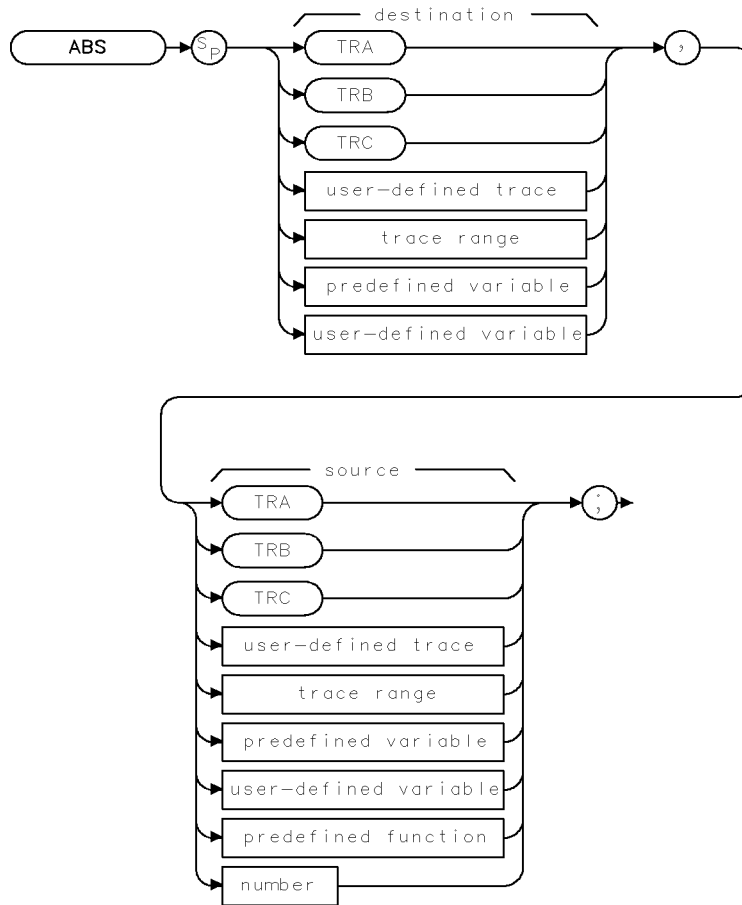

XABS

Item	Description/Default	Range
User-defined trace	A trace defined by the TRDEF command.	Any valid trace name.
User-defined variable	A variable defined by VARDEF command.	Any valid variable name.
Predefined variable	A command that acts as a variable. Refer to Table 4-1.	
Predefined function	Function that returns a value. Refer to Table 4-1.	
Trace range	A segment of trace A, trace B, trace C, or a user-defined trace.	
Number	Any real or integer number.	Real number range.

Prerequisite Commands: TRDEF when using user-defined trace VARDEF when using user-defined variable. TS when using trace data.

ABS Absolute

Example

10 OUTPUT 718;"IP;SNGLS;"	<i>Initializes instrument, stops sweeping.</i>
20 OUTPUT 718;"VARDEF P_OINT,0;"	<i>Defines a variable, called P_OINT, and initializes it to 0.</i>
30 OUTPUT 718;"ABS P_OINT,-2;"	<i>Places the absolute value of -2 into POINT.</i>
40 OUTPUT 718;"P_OINT?;"	<i>Returns value of POINT to computer.</i>
50 ENTER 718;Second	<i>Assigns value to computer variable, Second.</i>
60 DISP Second	<i>Displays the absolute value (2).</i>
70 END	

Description

The ABS command places the absolute value of the source values in the destination.

The source and the destination may be different lengths. The lengths of predefined traces (trace A, trace B, or trace C) is 401, while user-defined traces have a length of up to 2047, and variables have a length of 1. When the source is longer than the destination, the source is truncated to fit. When the source is shorter than the destination, the last element is repeated to fill the destination.

ADD Add

Adds the sources and sends the sum to the destination.

Syntax

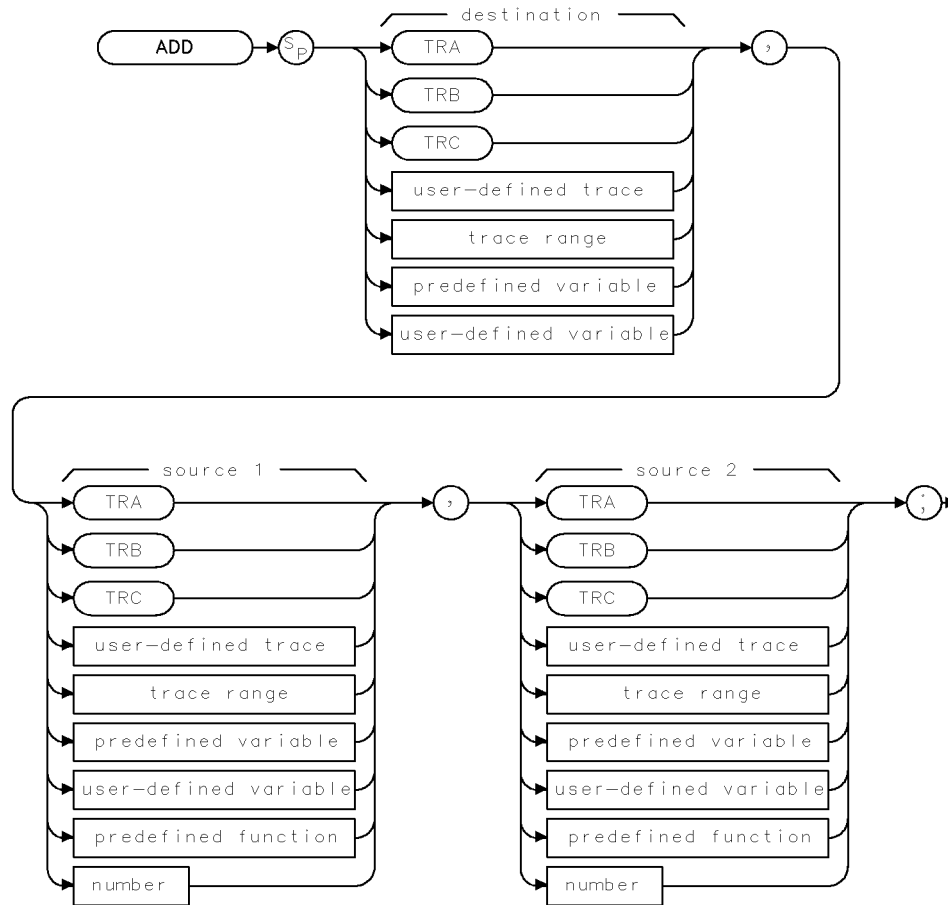

XADD

Item	Description/Default	Range
User-defined trace	A trace defined by the TRDEF command.	Any valid trace name.
User-defined variable	A variable defined by VARDEF command.	Any valid variable name.
Predefined variable	A command that acts as a variable. Refer to Table 4-1.	
Predefined funn	Function that returns a value. Refer to Table 4-1.	
Trace range	A segment of trace A, trace B, trace C, or a user-defined trace.	
Number	Any real or integer number.	Real number range.

Prerequisite Commands: TRDEF when using user-defined trace. VARDEF when using user-defined variable. TS when using trace data.

Related Commands: AMBPL, APB, SUB.

ADD Add

Example

Add 38 MHz to the center frequency, then store the sum in a user-defined variable.

10 OUTPUT 718;"IP;"	<i>Initializes instrument.</i>
20 OUTPUT 718;"CF 300MHZ;"	<i>Changes the center frequency.</i>
30 OUTPUT 718;"VARDEF N_EW,0;"	<i>Defines a variable, N_EW, and initializes it to 0.</i>
40 OUTPUT 718;"ADD N_EW,CF,38E6;"	<i>Adds 38 MHz to the center frequency, then places the sum in N_EW.</i>
50 OUTPUT 718;"N_EW?;"	<i>Returns value of N_EW to the computer.</i>
60 ENTER 718;Freq	<i>Assigns value to variable, Freq.</i>
70 DISP Freq	<i>Displays Freq on computer display.</i>
80 END	

Description

The ADD command adds values of source 1 and source 2 (point by point), and sends the sum to the destination.

Traces, user-defined traces, and trace ranges are added as 16-bit integers. Negative numbers are represented in two's complement format. Single variables and numbers are treated as floating point numbers and must be within the real number range as defined in Table 4-1.

The sources and destination may be different lengths. The length of predefined traces (trace A, trace B, or trace C) is 401. User-defined traces have a length of up to 2047, and variables have a length of 1. When sources differ in length, the last element of the shorter source is repeated for the addition process. After the addition, the last element is repeated if the destination is longer than the sum trace. When the sources are longer than the destination, they are truncated to fit.

AMB Trace A Minus Trace B

Subtracts trace B from trace A.

Syntax

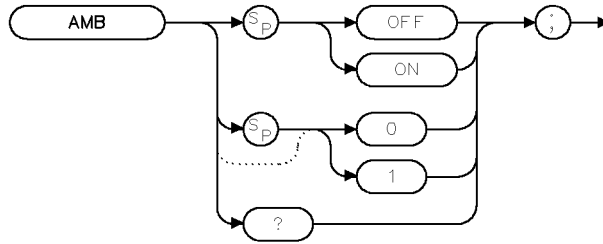

XAMB

Preset State: AMB OFF
 Related Commands: CLRW, CONTS, MXMH, SNGLS, TS, VAVG, VIEW
 Equivalent Softkey: A - B -> A ON OFF

Example 1

<pre> 10 OUTPUT 718;"IP;AUNITS DBUV;RL 80;" 20 OUTPUT 718;"CLRW TRB;TS;VIEW TRB;AMB ON;" 30 OUTPUT 718;"AMB?;" 40 ENTER 718;Reply\$ 50 DISP Reply\$ 60 END </pre>	<p><i>Initializes instrument.</i></p> <p><i>Displays trace B and turns on the AMB function. If trace A and trace B contain exactly the same trace data, the result is trace data at 0 measurement units, at the bottom of the display.</i></p> <p><i>Queries the state of the AMB function. The query response is placed in a string variable.</i></p> <p><i>"ON" is displayed on the computer display.</i></p>
--	---

AMB Trace A Minus Trace B

Example 2

10 OUTPUT 718;"IP;AUNITS DBUV;RL 80;SNGLS;"	<i>Initializes instrument.</i>
20 OUTPUT 718;"MOV TRA, 8000;"	<i>Each element of trace A is set to 8000 measurement units.</i>
30 OUTPUT 718;"VIEW TRA;"	<i>Places trace A in the view mode.</i>
40 OUTPUT 718;"MOV TRB,7000;"	<i>Each element of trace B is set to 7000 measurement units.</i>
50 OUTPUT 718;"VIEW TRB;"	<i>Places trace B in the view mode.</i>
60 OUTPUT 718;"AMB ON;"	<i>Subtracts trace B from trace A.</i>
70 OUTPUT 718;"BLANK TRB;VIEW TRA;"	<i>The result is displayed at 1000 measurement units.</i>
80 END	

Example 3

10 OUTPUT 718;"IP;SNGLS;AUNITS DBUV;RL 80DB;"	<i>Initializes the instrument and sets the reference level.</i>
20 OUTPUT 718;"MOV TRA,5000;"	<i>Sets trace A to 5000 measurement units, which is equal to 50 dBμV.</i>
30 OUTPUT 718;"VIEW TRA;"	<i>Places trace A in the view mode.</i>
40 OUTPUT 718;"MOV TRB,4000;"	<i>Sets trace B to 4000 measurement units, which is equal to 40 dBμV.</i>
50 OUTPUT 718;"VIEW TRB;"	
60 OUTPUT 718;"DL 60DB;"	<i>Sets display line to 60 dBμ, which is at 6000 measurement units.</i>
70 OUTPUT 718;"BML;"	<i>Subtracts trace B minus display line. Result is 4000 – 6000 = –2000 measurements units (off screen).</i>
80 OUTPUT 718;"AMB ON;"	<i>Subtracts trace A minus modified trace B (5000 – (–2000) = 7000 or 70 dBμV. Notice that this has resulted in a subtraction of amplitude in dBμV, 50 dBμV – (–20 dBμV) = 70 dBμV.</i>
90 OUTPUT 718;"BLANK TRB;VIEW TRA;"	
100 END	

Description

The AMB command subtracts trace B from trace A (point by point), and sends the result to trace A. The AMB function remains in effect until it is turned off by executing "AMB OFF;".

The AMB command is a trace math command and subtracts trace B from trace A in measurement units (see "CTA" for information about measurement units). Because subtracting trace B from trace A can cause the result in trace A to be displayed off screen, the trace A minus trace B plus display line (AMBPL) command can be used. As shown in example 2, if the trace data value of trace A is 92 dB μ V (107 dB μ V for the receiver RF section only), (8000 measurement units), and trace B is –10 dBm (7000 measurement units), the result of executing AMB is 1000 measurement units. If the AMBPL command is used instead of AMB, and the display line is set at –50 dB μ V (mid-screen), the result in trace A is kept at mid-screen.

AMB Trace A Minus Trace B

A common use of trace subtraction is to normalize one trace with respect to another. For example, traces are frequently subtracted to normalize the instrument response when a tracking generator is used. In such applications, amplitude units in $\text{dB}\mu\text{V}$ should be subtracted. As shown in example 2, subtraction of measurement units is not equivalent to subtraction of amplitude units. Correct results are obtained if the display line is set to $0 \text{ dB}\mu\text{V}$ using DL, and BML is used to subtract the display line from trace B. See example 3 for an example of subtracting the display line from trace B.

Query Response

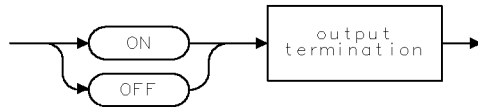

002

AMBPL Trace A Minus Trace B Plus Display Line

Subtracts trace B from trace A.

Syntax

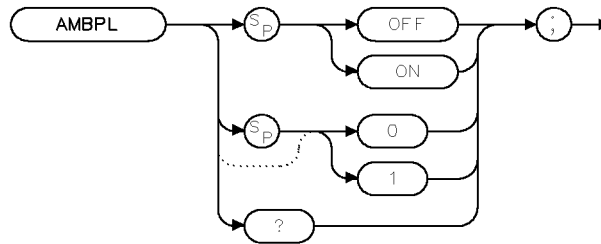

XAMBPL

Equivalent Softkey:

NORMLIZE ON OFF

Preset State:

AMBPL OFF

Related Commands:

ADD, AMB, CONTS, CLRW, DL, MXMH, SNGLS, SUB, TS, VAVG, VIEW

Example

<pre>10 OUTPUT 718;"IP;AUNITS DBUF;SNGLS;RL 80DB;" 20 OUTPUT 718;"MOV TRA,5000;" 30 OUTPUT 718;"VIEW TRA;" 40 OUTPUT 718;"MOV TRB,4000;" 50 OUTPUT 718;"VIEW TRB;" 60 OUTPUT 718;"DL 60DM;" 70 OUTPUT 718;"AMBPL ON;" 80 OUTPUT 718;"BLANK TRB;VIEW TRA;" 90 END</pre>	<p><i>Initializes instrument, activates single-sweep mode.</i></p> <p><i>Sets trace A to 5000 measurement units, which is equal to 50 dBμV.</i></p> <p><i>Sets trace B to 4000 measurement units, which is equal to 40 dBμV.</i></p> <p><i>Sets display line to 60 dBμV, which is at 6000 measurement units.</i></p> <p><i>Performs trace A – trace B + display line. The result is 5000 – 4000 + 6000 = 7000 or 70 dBμV. Note that this has resulted in a subtraction of amplitude in dBμV, 50 dBμV – (–20 dBμV) = 70 dBμV.</i></p>
---	--

AMBPL Trace A Minus Trace B Plus Display Line

Description

The AMBPL command subtracts trace B from trace A (point by point), adds the display line value to the difference, and sends the result to trace A. The AMBPL function remains in effect until it is turned off by executing "AMBPL OFF;".

A common use of trace subtraction is to normalize one trace with respect to another. For example, traces are frequently subtracted to normalize the instrument response when a tracking generator is used. In such applications, amplitude units in $\text{dB}\mu\text{V}$ should be subtracted. To accomplish this, the display line should be set to $0 \text{ dB}\mu\text{V}$ using DL as shown in the example. To compare how you would use the AMB command to do the same operation, see examples 2 and 3 for the AMB command.

Query Response

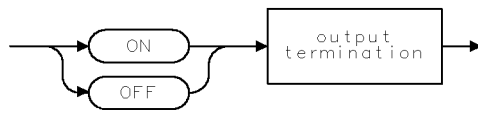

Q02

AMPCOR

Amplitude Correction

Applies amplitude corrections at specified frequencies.

Syntax

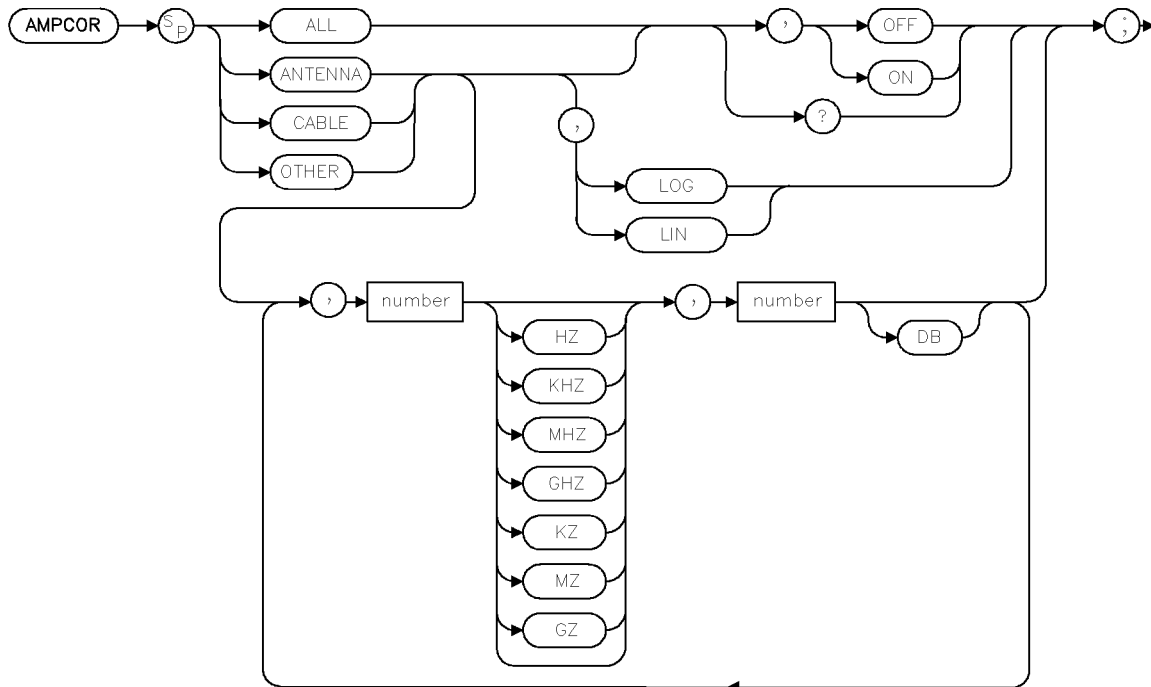

xampcorr

Item	Description/Default	Range
Number	Any real or integer number. Default unit is dB.	Frequency: 0 to 1000 GHz Amplitude: ±327 dB.

Equivalent Softkeys: the softkeys accessed by **Correctn Factors**

Preset State: AMPCOR ALL OFF

Related Commands: XUNITS, AUNITS

Note ANTENNA corrections interact with the instrument's AUNITS setting. When AMPCOR ANTENNA corrections are on, AUNITS are as specified by the XUNITS command. When ANTENNA corrections are off, AUNITS are the currently selected amplitude units, that is, as specified by the AUNITS command (default dBm). Refer to the XUNITS command for more information.

Example

Compensate for frequency-dependent amplitude inaccuracies at the input.

10	DIM A\$ [200]	
20	OUTPUT 718;"CF 1GHZ;SP 200MHZ;"	<i>Sets center frequency and span.</i>
30	OUTPUT 718;"AMPCOR CABLE, 100MHZ,5DB, 1GHZ,-5DB,1.5GHZ,10DB;"	<i>Stores frequency-amplitude pairs in receiver. Notice that frequencies are in ascending order.</i>
40	OUTPUT 718;"AMPCOR CABLE?;"	<i>Returns correction values to computer.</i>
50	ENTER 718;A\$	
60	PRINT A\$	<i>Displays the frequency-amplitude pairs.</i>
70	OUTPUT 718;"AMPCOR OFF;"	<i>Turns off the amplitude correction constants.</i>
80	OUTPUT 718;"AMPCOR CABLE?;"	
90	ENTER 718;A\$	
100	PRINT A\$	<i>Because AMPCOR is off, "0,0" is displayed.</i>
110	END	

Description

Use AMPCOR to compensate for frequency-dependent amplitude variations at the receiver input.

AMPCOR consists of three independent sets of correction data. The three data sets are: ANTENNA, CABLE, and OTHER. Each data set may be turned on or off independently and the entire AMPCOR system may be turned on or off.

Turning on any of the ANTENNA, CABLE, or OTHER data sets causes ALL currently enabled AMPCOR data to be used. Setting AMPCOR ALL OFF disables the feature. Setting AMPCOR ALL ON will restore the current mix of data. That is, sending the following commands disables all amplitude correction.

```
AMPCOR ANTENNA,ON;
AMPCOR CABLE,OFF;
AMPCOR OTHER,ON;
AMPCOR ALL,OFF;
```

Sending, AMPCOR ALL,ON; enables ANTENNA and OTHER, since these two data sets were turned on.

Up to 80 pairs of frequency-amplitude correction points can be entered in each of the three data sets, restricted to a total of 80 frequency points among the three sets.

Each set of corrections (or data set) is interpolated using either a linear frequency scale or a logarithmic frequency scale.

SETUP Correctn Factors

The individual amplitude correction factors can be saved or edited on disk using the softkeys in the **SETUP** menu under **Correctn Factors** or by using the STOR command.

Note When AMPCOR ANTENNA correction factors are ON, the current XUNITS is used. When AMPCOR ANTENNA correction factors are OFF, the current AUNITS is used.

AMPCOR Amplitude Correction

Query Response

AMPCOR ANTENNA?, AMPCOR CABLE?, and AMPCOR OTHER? return the frequency and amplitude correction pairs.

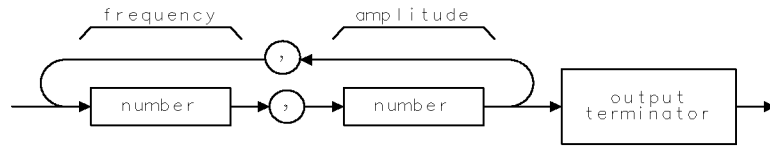

QAMPCOR .

Returned values are 0,0 when AMPCOR is set to OFF.

AMPLEN Amplitude Correction Length

Returns the number of frequency-amplitude correction factors that have been entered.

Syntax

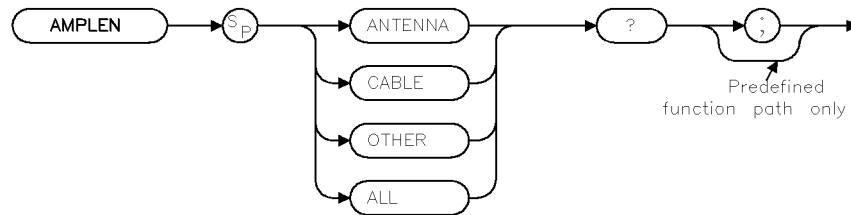

xampleng .

Related Commands: AMPCOR

Example

```
OUTPUT 718;"AMPLEN CABLE?;"
```

Description

The AMPLEN command returns the number of frequency-amplitude correction factors that have been entered. The absolute value of the number that AMPLEN? returns is the number of frequency-amplitude correction factors that have been entered. If no amplitude correction factors have been entered, AMPLEN? returns a 0. (See “AMPCOR” for more information about frequency-amplitude correction factors.)

AMPLEN returns the number of frequency-amplitude correction factors

as a positive or negative number. If AMPLEN returns a positive number, the frequency-amplitude correction factors are turned on. If AMPLEN returns a negative number, the frequency-amplitude correction factors are turned off.

Query Response

AMPLEN can return a number from 80 to -80.

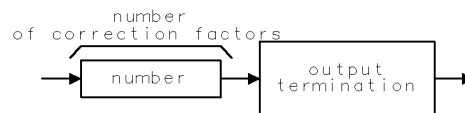

QAMPLEN .

ANNOT

Annotation

Turns on or off the display annotation.

Syntax

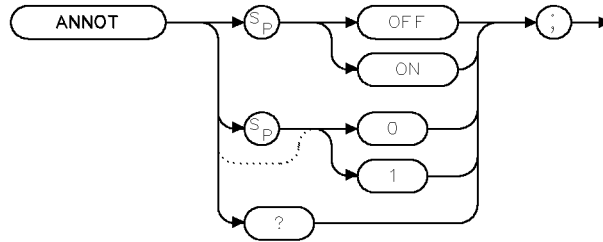

XANNOT

Equivalent Softkey: **ANNOTATN ON OFF**

Preset State: ANNOT ON

Related Commands: GRAT, TITLE

Example

```

10 OUTPUT 718;"ANNOT ON;" Turns on the annotation.
20 OUTPUT 718;"ANNOT?;" Queries state of the annotation function.
30 ENTER 718;Reply$ Places response in a variable.
40 DISP Reply$ Displays response on the computer screen.
50 END

```

Description

The ANNOT command turns on or off all the words and numbers (annotation) on the display (except for the softkey labels).

Query Response

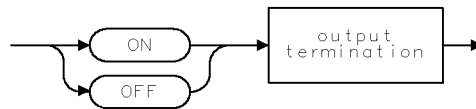

Q02

APB Trace A Plus Trace B

Adds trace A to trace B and sends the result to trace A.

Syntax

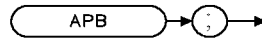

XAPB

Related Commands: CLRW, SNGLS, TS, VIEW

Example

10 OUTPUT 718;"IP;SNGLS;"	<i>Initializes instrument, changes to single-sweep mode.</i>
20 OUTPUT 718;"TS;"	<i>Updates the trace.</i>
30 OUTPUT 718;"VIEW TRA;RL 80DM;CLRW TRB;"	<i>Changes the reference level.</i>
40 OUTPUT 718;"TS;VIEW TRB;"	<i>Takes a measurement sweep.</i>
50 OUTPUT 718;"APB;"	<i>Activates APB command.</i>
60 OUTPUT 718;"BLANK TRB;VIEW TRA;"	<i>Displays the result of APB.</i>
70 END	

Description

The APB command adds trace A to trace B and sends the result to trace A. The traces are added as 16-bit integers. Negative numbers are represented in two's complement format. The two's complement representation of a negative number is obtained by changing the 1s to 0s in the binary representation of the number, and then binarily adding 1.

ARNG Auto Range

Enables or disables the auto-range function.

Syntax

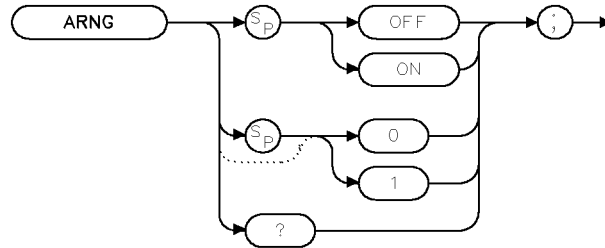

xarng

Equivalent Key: **AUTO RANGE**
Preset State: ARNG OFF
Related Commands: OVLD, AT, RL

Example

```
OUTPUT 718;"ARNG ON;"
```

Description

The ARNG command allows the user to enable, disable, or query the current state of the instrument's auto-range function. When enabled, the auto-range function automatically adjusts RF attenuation or reference level (IF step-gain) in response to either an IF or RF overload condition detected during the previous sweep.

Auto range requires overload detection capability. The RF filter section must be present (and not in a bypass state) for RF overload detection. IF overload detection does not require the RF filter section.

When enabled, auto range automatically enables overload detection. When disabled, auto range does *not* disable overload detection.

Query Response

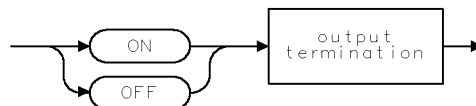

Q02

AT Attenuation

Specifies the RF input attenuation.

Syntax

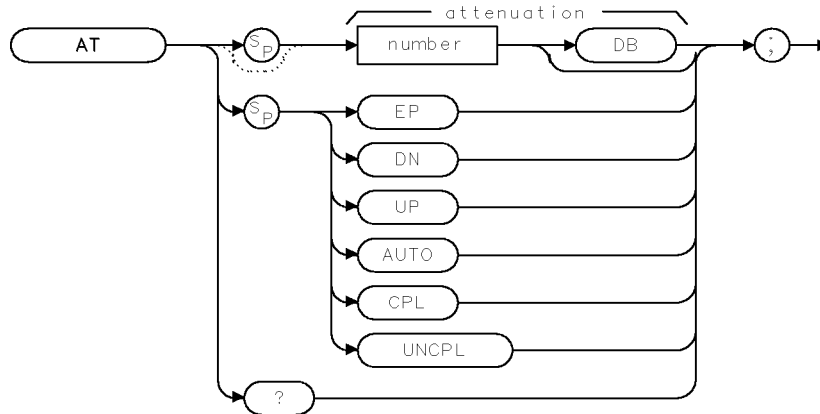

xat

Item	Description/Default	Range
Number	Any real or integer. Default units are dB.	Input attenuator range of receiver.

- Equivalent Softkey: **ATTEN AUTO MAN**
- Preset State: 10 dB
- Step Increment: in 10 dB steps
- Related Commands: AUTO, CPL, ML, RL

Example

```
OUTPUT 718;"AT 40DB;" Sets the attenuation to 40 dB.
OUTPUT 718;"AT UP;" Increases the attenuation to 50 dB.
```

Description

The AT command specifies the input attenuation in 10 dB steps. Normally, the input attenuator is coupled to the reference level. When a continuous wave signal is displayed with its peak at or below the reference level, the coupling keeps the mixer input level at or below the specified level. The AT command allows less than the specified value at the mixer input.

When the attenuation is increased with the AT command, the reference level does not change. If the attenuation is decreased from the coupled value using the AT command, the reference level will be decreased. When the reference level is changed using the RL command, the input attenuation changes to maintain a constant signal level on the display if attenuation is auto-coupled. Using auto-couple resets the attenuation value so that a continuous wave signal

AT Attenuation

displayed at the reference level yields -10 dBm (or the specified mixer level) at the mixer input.

The step keys, knob, and DN parameter do not allow an attenuation entry below 10 dB. Only direct entry of “AT 0DB;” will achieve 0 dB attenuation.

CAUTION Signal levels above +30 dBm will damage the receiver.

The CPL and UNCPL parameters allow greater control in distribution of system input attenuation when the optional RF filter section is present in the system. At instrument preset, the input attenuator is used exclusively to control system input attenuation when the filter section is in either the 9 kHz to 50 MHz input path (INPUT 1), or the 20 MHz to 2.9 GHz input path (INPUT 2).

The UNCPL parameter “uncouples” the filter section’s attenuator from system control, leaving it at its current setting. When the filter section’s attenuator has been uncoupled, changes to system attenuation will not change the setting of the filter section’s input attenuator. The CPL parameter re-establishes system control of the filter section’s attenuator.

Query Response

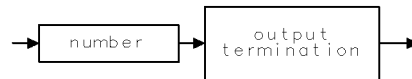

QQ1

AUNITS Amplitude Units

Specifies the amplitude units for input, output, and display.

Syntax

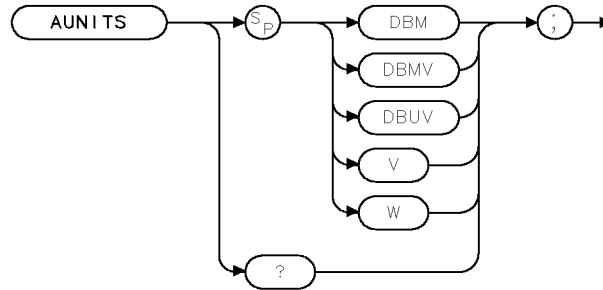

XAUNITS .

Equivalent Softkey: Amptd Units

Related Commands: CAL, DL, MKA, RL, TH, AMPCOR ANTENNA, XUNITS

Example

OUTPUT 718;"LN;"	<i>Changes instrument to linear mode.</i>
OUTPUT 718;"AUNITS DBMV;"	<i>Changes the linear amplitude units to DBMV.</i>
OUTPUT 718;"AUNITS?;"	<i>Queries current amplitude units.</i>
ENTER 718;Reply\$	<i>Puts response in a variable.</i>
DISP Reply\$	<i>Displays response on the computer screen.</i>

Description

The AUNITS command sets the amplitude readouts (reference level, marker, display line, and threshold) to the specified units. Different amplitude units can be set for log and linear amplitude scales.

Note When AMPCOR antenna correction factors are ON, the current XUNITS is used. When AMPCOR antenna correction factors are OFF, the current AUNITS is used.

AUNITS Amplitude Units

Query Response

The query response returns the current amplitude units for the current amplitude scale.

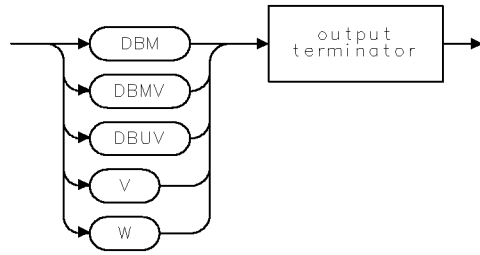

QAUNITS .

AUTO Auto Couple

Couples the active functions automatically.

Syntax

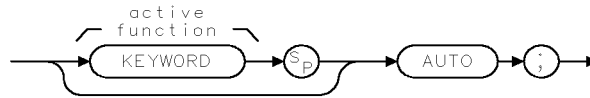

QAUTO

Equivalent Softkey: **AUTO ALL**

Related Commands: AVBW, AT, DL, HD, IFBW, MKA, MKD, MKF, MKFCR, MKN, SRCPSTP, SRCPSWP, SRCPWR, SS, ST, TH, VAVG, VBR

Example

OUTPUT 718;"AT AUTO;" *Couples the attenuation.*
 OUTPUT 718;"HD;AUTO;" *Couples all functions.*
 OUTPUT 718;"AUTO;" *Couples and deactivates a related function (if one was active), or couples all functions (if no functions were active).*

Description

The result of the AUTO command depends on the active function it acts upon. The functions that are affected by the AUTO parameter are:

AT	couples attenuation to the reference level.
AVBW	couples average video bandwidth to intermediate frequency.
DL	turns off display of line but does not change the value of the display line.
IFBW	couples intermediate frequency bandwidth to frequency.
MKA	turns off marker.
MKD	turns off marker.
MKF	turns off marker.
MKFCR	deactivates use of user-supplied counter resolution value, however, the value remains unchanged.
MKN	turns off marker.
SRCPSTP	sets source power step to 0 (it may value may be displayed at 10 however).
SRCPSWP	turns off power sweep.
SRCPWR	turns off source power.
SS	couples step size to frequency span.
ST	couples sweep time to frequency span.
TH	turns off display of threshold, but does not change its value or prevent usage in peak searching.
VAVG	stops averaging.
VB	couples video bandwidth to resolution bandwidth.
VBR	sets the video to bandwidth ratio to 0.3.

AUTO Auto Couple

Individual functions can be coupled by entering the keyword for the command before AUTO, for example, "AT AUTO;"

AUTO has no effect if the active function is not in the above list.

Executing "AUTO;" if no functions are active, couples all functions. Executing "HD;AUTO;" couples all functions, turns off the reference position, and turns off normalization.

AUTOAVG Auto Average

Turns on and off the automatic measuring of the average detector.

Syntax

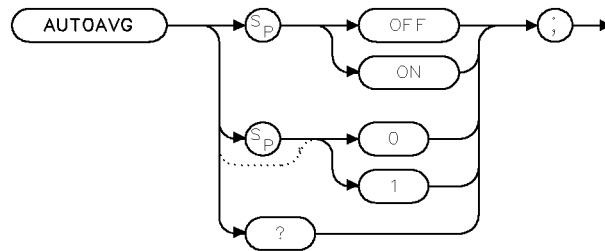

xautavg .

Equivalent Softkey: **DETECTOR PK QP AV**

Preset Value: AUTOAVG ON

Related Commands: AUTOQPD, MEASFREQ, MEASSIG, REMEASSIG, MEASALLSIGS

Example

OUTPUT 718;"AUTOAVG ON:"

Description

The AUTOAVG command turns on and off automatic measuring of the average detector. This affects which detectors are measured using the **MEAS STEPPED** softkey or during the MEASFREQ, MEASSIG, REMEASSIG and MEASALLSIGS commands.

Query Response

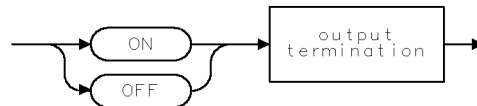

002 .

AUTOCAL

Automatic Calibration

Returns the status of the EMI receiver automatic calibration feature.

Syntax

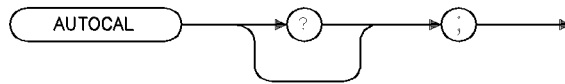

xautocl

Equivalent Softkey: **AUTO CAL ON OFF**

Related Commands: CAL AUTOON, CAL AUTOOFF, CALTIME

Example

```
OUTPUT 718; "AUTOCAL;"  
ENTER 718;A  
DISP A
```

Description

The AUTOCAL command returns the status of the EMI receiver automatic calibration feature. A "0" is returned if an automatic calibration is disabled, a "1" is returned if auto cal is enabled.

Query Response

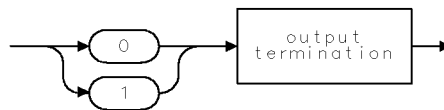

qgen1

AUTOQPD Quasi-Peak Detector

Turns on and off the automatic measuring of the quasi-peak detector.

Syntax

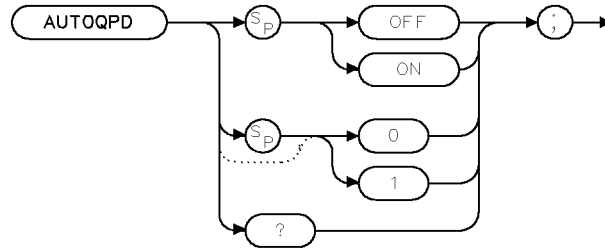

xoutqpk .

Equivalent Softkey: **DETECTOR PK QP AV**
 Preset Value: AUTOQPD ON
 Related Commands: AUTOAVG, MEASSIG, REMEASSIG, MEASALLSIGS

Example

OUTPUT 718; "AUTOQPD ON:"

Description

The AUTOQPD command turns on and off automatic measuring of the quasi-peak detector. This affects which detectors are measured during the MEASSIG, REMEASSIG, and MEASALLSIGS commands.

Query Response

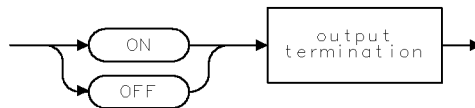

Q02 .

AVBW

Average Video Bandwidth

Specifies the average video bandwidth.

Syntax

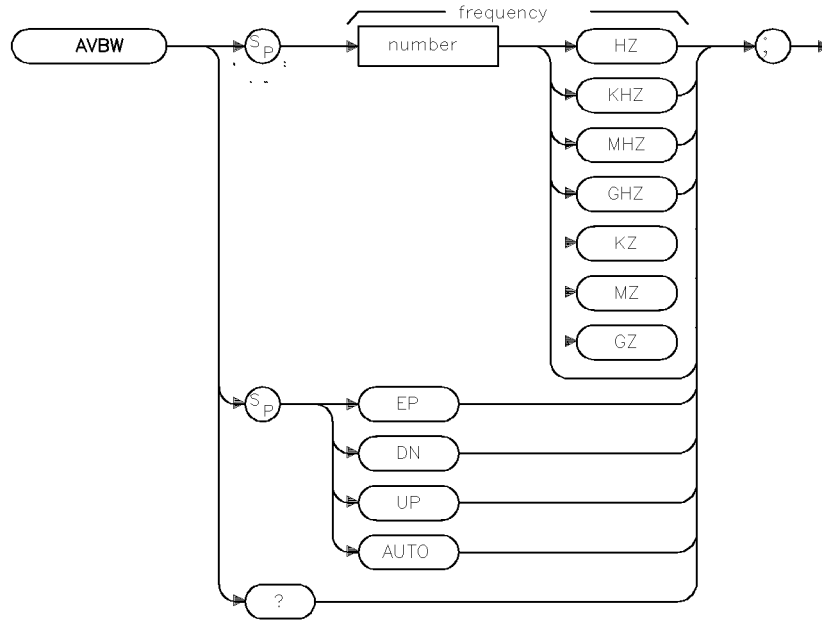

xavbw

Item	Description/Default	Range
Number	Any real or integer number. Default unit is Hz.	30 Hz to 3 MHz.

Equivalent Softkeys: **AVG BW AUTO MAN**

Preset State: 300 kHz

Step Increment: In a 1, 3, 10 sequence

Related Commands: AUTO, IFBW, RB, SP, ST, VB, VBR

Example

OUTPUT 718;"AVBW 10KHZ;" *Changes the average video bandwidth to 10 kHz.*

Description

The AVBW command specifies the average video bandwidth, which is a post-detection, low-pass filter. The intermediate frequency bandwidth, video bandwidth, and sweep time are normally coupled to the span. Executing AVBW uncouples the average video bandwidth from intermediate frequency bandwidth (it does nothing to the sweep time and span coupling). Executing AUTO recouples average video bandwidth to the intermediate frequency bandwidth.

Frequency values other than the values in the 1, 3, 10 sequence are rounded to the nearest permissible value.

Query Response

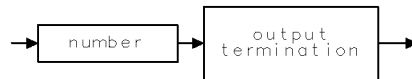

001

AVG

Average

Averages the source and the destination.

Syntax

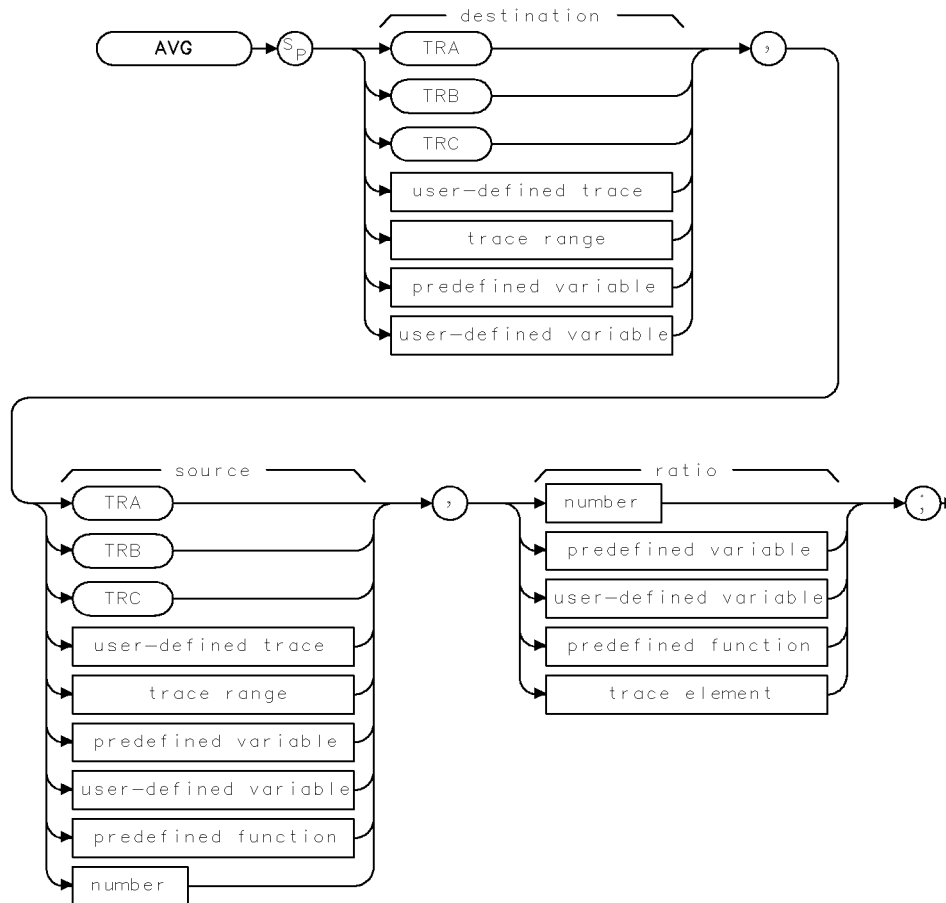

XAVG

Item	Description/Default	Range
User-defined trace	A trace defined by the TRDEF command.	Any valid trace name.
User-defined variable	A variable defined by VARDEF command.	Any valid variable name.
Predefined variable	A command that acts as a variable. Refer to Table 4-1.	
Predefined function	Function that returns a value. Refer to Table 4-1.	
Trace range	A segment of trace A, trace B, trace C, or a user-defined trace.	
Trace element	An element of trace A, trace B, trace C, or a user-defined trace.	
Number	Any real or integer number.	Real number range.

Prerequisite Commands: TRDEF when using a user-defined trace. VARDEF when using a user-defined variable. TS when using trace data.

Related Commands: CLRAVG, TS

Example

10 OUTPUT 718;"IP;"	<i>Initializes instrument.</i>
20 OUTPUT 718;"SNGLS;"	<i>Activates single-sweep mode.</i>
30 OUTPUT 718;"DET POS;TS;"	<i>Activates the positive-peak detector and updates the trace.</i>
40 OUTPUT 718;"VIEW TRA;"	<i>Stores results and displays trace A.</i>
50 OUTPUT 718;"DET SMP;"	<i>Activates sample detection.</i>
60 OUTPUT 718;"CLR W TRB;TS;"	<i>Activates trace B and takes a sweep of trace B.</i>
70 OUTPUT 718;"VIEW TRB;"	<i>Displays trace B.</i>
80 OUTPUT 718;"AVG TRA,TRB,2;"	<i>Averages traces B and A with ratio of 2 and stores the result in trace A.</i>
90 OUTPUT 718;"BLANK TRB;"	<i>Blanks trace B and displays result in trace A.</i>
100 END	

Description

The AVG command averages the source and the destination and then stores the result in the destination according to the following algorithm:

$$\text{Average} = \frac{((\text{ratio} - 1) \times \text{destination}) + \text{source}}{\text{ratio}}$$

The results of AVG are invalid if the ratio is equal to zero.

When the source is longer than the destination, the source is truncated to fit. When the source is shorter than the destination, the last element is repeated to fill the destination.

AXB

Exchange Trace A and Trace B

Exchanges trace A and trace B.

Syntax

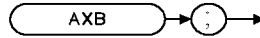

XAXB

Equivalent Softkey: **A <--> B**

Related Commands: CLRW, SNGLS, TS, VIEW

Example

10 OUTPUT 718;"IP;"	<i>Initializes instrument.</i>
20 OUTPUT 718;"SNGLS;"	<i>Activates single-sweep mode.</i>
30 OUTPUT 718;"DET POS;TS;"	<i>Activates positive-peak detection of trace A.</i>
40 OUTPUT 718;"VIEW TRA;"	<i>Stores results, displays trace A.</i>
50 OUTPUT 718;"DET SMP;"	<i>Activates sample detection.</i>
60 OUTPUT 718;"CLRW TRB;TS;"	<i>Clear-writes trace B and takes sweep.</i>
70 OUTPUT 718;"VIEW TRB;"	<i>Stores results of sweep in trace B.</i>
80 OUTPUT 718;"AXB;"	<i>Exchanges trace A with trace B.</i>
90 OUTPUT 718;"BLANK TRB;"	<i>Blanks trace B, leaving only trace A on screen.</i>
100 END	

Description

The AXB command exchanges trace A and trace B, point by point. AXB sets trace A and trace B to the view mode.

BAUDRATE Baud Rate of Instrument

Specifies the baud rate of an instrument with the RS-232 interface installed.

Note The RS-232 interface is only available with Option 023.

Syntax

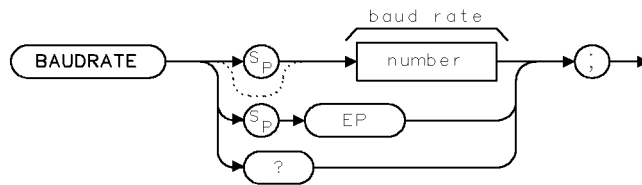

XBAUDRATE

Item	Description/Default	Range
Number	Any valid integer number.	4 to 57600.

Equivalent Softkey: **BAUD RATE**

Require Option: Option 023

Example

OUTPUT 718; "BAUDRATE 1200;"

BAUDRATE Baud Rate of Instrument

Description

The BAUDRATE command changes the baud rate of the instrument to one of the standard baud rates. The standard baud rates are as follows: 300, 1200, 2400, 4800, 9600, and 19200. If you specify a baud rate other than one of the standard baud rates, the nearest standard baud rate will be used.

To communicate with the computer, the baud rates of the instrument and the computer must be the same. Because changing the baud rate of the instrument within a program ends communication with the computer, you should only use BAUDRATE when using the external keyboard to enter programming commands. To reestablish communication with the computer, you must set the baud rate back to the baud rate of the computer.

Query Response

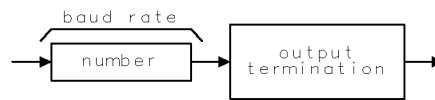

QBAUDRATE

BIT Bit

Places the state (“1” or “0”) of a bit in the destination.

Syntax

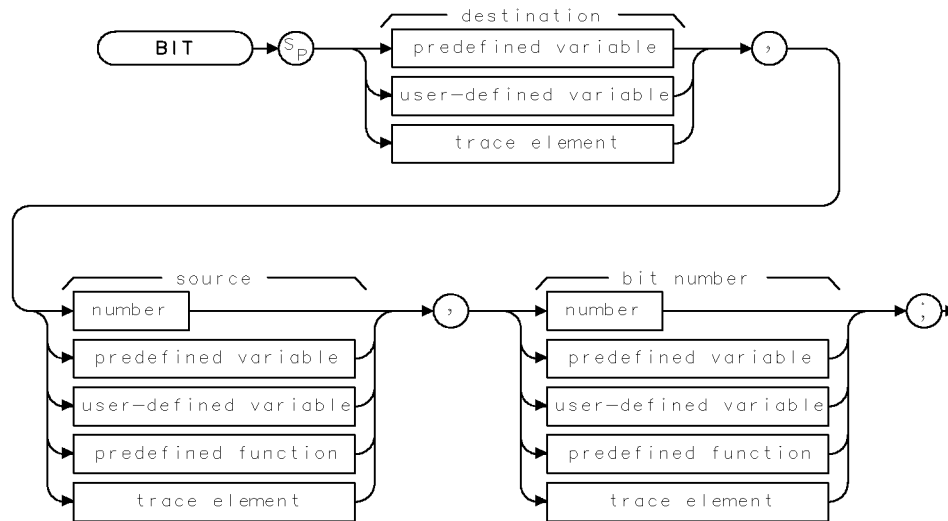

XBIT

Item	Description/Default	Range
User-defined variable	A variable defined by VARDEF command.	Any valid variable name.
Predefined variable	A command that acts as a variable. Refer to Table 4-1.	
Predefined function	Function that returns a value. Refer to Table 4-1.	
Trace element	An element of trace A, trace B, trace C, or a user-defined trace.	64-bit integer.
Number (source)	Any valid integer number.	
Number (bit number)	Any valid integer number.	

Prerequisite Commands: VARDEF when using a user-defined variable.

Related Commands: INT, STB

BIT Bit

Example

10 CLEAR 718	<i>Clears HP-IB bus.</i>
20 OUTPUT 718;"IP;"	<i>Initializes instrument.</i>
30 OUTPUT 718;"VARDEF E_RROR,0;"	<i>Defines user-defined variable E_RROR and sets it equal to 0.</i>
40 OUTPUT 718;"BIT E_RROR,STB,5;"	<i>Stores value of bit 5 of status byte in E_RROR.</i>
50 OUTPUT 718;"E_RROR?;"	<i>Returns value of E_RROR.</i>
60 ENTER 718;Err	<i>Assigns value to computer variable, Err.</i>
70 IF NOT Err THEN DISP "NO ";	<i>If Err equals zero, displays "NO" on computer screen.</i>
80 DISP "ERROR PRESENT";	<i>Displays "ERROR PRESENT" on computer screen.</i>
90 END	

Description

The BIT places either a "0" or a "1" in the destination. A "0" indicates the bit is off, a "1" indicates the bit is on.

Specifying the bit number: When you specify the bit number, remember the following:

- The bit number is limited from 0 to 63. If you enter a negative number for the bit number, the bit number defaults to 0. If you enter a number that is greater than 63, the bit number defaults to the remainder of the number divided by 64.
- The least significant bit is bit 0. The most significant bit is bit 63.
- Floating-point numbers are changed to a 64-bit integer before BIT is executed.

The BIT command can be used to determine information about the status byte or a memory disk inserted into the instrument's memory disk reader. (See "HAVE" for more information about determining information about the memory disk.)

BITF Bit Flag

Returns the state (“1” or “0”) of a bit.

Syntax

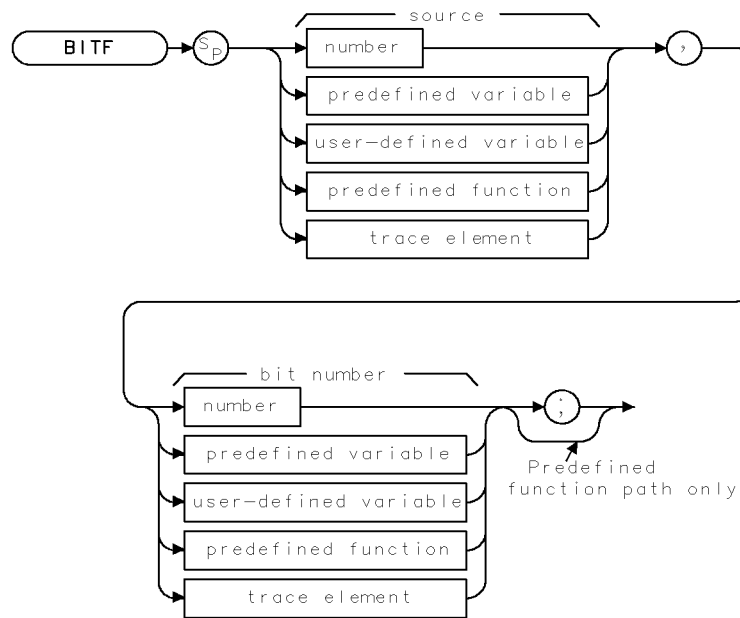

XBITF

Item	Description/Default	Range
User-defined variable	A variable defined by VARDEF command.	Any valid variable name.
Predefined variable	A command that acts as a variable. Refer to Table 4-1.	
Predefined function	Function that returns a value. Refer to Table 4-1.	
Trace element	An element of trace A, trace B, trace C, or a user-defined trace.	
Number (source)	Any valid integer number.	64-bit integer.
Number (bit number)	Any valid integer number.	0 to 63.

Prerequisite Commands: VARDEF when using a user-defined variable.

Related Commands: BIT

BITF Bit Flag

Example

10 CLEAR 718	<i>Clears HP-IB bus.</i>
20 OUTPUT 718;"IP;"	<i>Initializes instrument.</i>
30 OUTPUT 718;"BITF STB,5;"	<i>Determines the value of bit 5 of status byte.</i>
40 ENTER 718;Err	<i>Assigns value to computer variable, Err.</i>
50 IF NOT Err THEN DISP "NO ";	<i>If Err equals zero, displays "NO" on computer screen.</i>
60 DISP "ERROR PRESENT";	<i>Displays "ERROR PRESENT" on computer screen.</i>
70 END	

Description

The value returned by BITF is either a "0" or a "1." A "0" indicates the bit is off, a "1" indicates the bit is on. Unlike BIT, BITF returns the state of the bit directly; the state of the bit is not stored in a destination.

Specifying the bit number: When you specify the bit number, remember the following:

- The bit number is limited from 0 to 63. If you enter a negative number for the bit number, the bit number defaults to 0. If you enter a number that is greater than 63, the bit number defaults to the remainder of the number divided by 64.
- The least significant bit is bit 0. The most significant bit is bit 63.
- Floating-point numbers are changed to a 64-bit integer before BITF is executed.

The BITF command can be used to determine information about the status byte or a memory disk inserted into the instrument's memory disk reader. (See "HAVE" for more information about determining information about the memory disk.)

BLANK Blank Trace

Blanks trace A, trace B, or trace C and stops taking new data into the specified trace.

Syntax

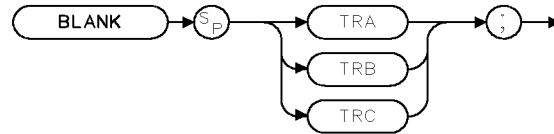

XBLANK

Equivalent Softkeys: `BLANK A`, `BLANK B`, and `BLANK C`

Preset State: `BLANK TRB`, `BLANK TRC`

Related Commands: `CLR`, `MXMH`, `TRDSP`, `VIEW`

Example

```
OUTPUT 718;"BLANK TRA;"
```

Description

The BLANK command blanks trace A, trace B, or trace C and stops taking new data into the specified trace.

BML

Trace B Minus Display Line

Subtracts display line from trace B and places the result in trace B.

Syntax

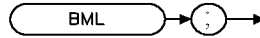

XBML

Equivalent Softkey: `B - DL -> B`

Related Commands: BLANK, CLRW, SUB, TS

Example

```
10 OUTPUT 718;"IP;SNGLS;"      Initializes instrument, activates single-sweep mode.
20 OUTPUT 718;"BLANK TRA;"     Blanks trace A.
30 OUTPUT 718;"CLRW TRB;TS;"   Clear-writes trace B, takes sweep.
40 OUTPUT 718;"DL 22DB;"       Sets the display line to 22 dBμV.
50 OUTPUT 718;"BML;"           Activates BML function.
60 END
```

Note For a receiver RF section standalone, set the display line to 37 dBμV.

Description

The BML command subtracts the display line from trace B (point by point), and sends the difference to trace B.

BTC

Transfer Trace B to Trace C

Transfers trace B into trace C.

Syntax

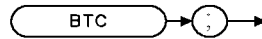

XBTC

Equivalent Softkey: `B -> C`

Related Commands: BLANK, CLRW, SNGLS, TS, VIEW

Example

10 OUTPUT 718;"IP;"	<i>Initializes instrument.</i>
20 OUTPUT 718;"SNGLS;"	<i>Activates single-sweep mode.</i>
30 OUTPUT 718;"BLANK TRA;"	<i>Blanks trace A.</i>
40 OUTPUT 718;"CF 300 MHZ;SP 1MHZ;"	<i>Sets up measurement range.</i>
50 OUTPUT 718;"CLRW TRB;TS;"	<i>Takes measurement sweep.</i>
60 OUTPUT 718;"BTC;"	<i>Moves trace B to trace C.</i>
70 OUTPUT 718;"BLANK TRB;VIEW TRC;"	<i>Displays result in trace C.</i>
80 END	

Description

The BTC command moves trace B into trace C, then stops updating trace C by placing it in the view mode. Trace B is unchanged by BTC. Trace B must contain a complete sweep of measurement information.

BXC

Trace B Exchange Trace C

Exchanges trace B and trace C.

Syntax

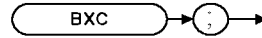

xBXC

Equivalent Softkey: **B <--> C**

Related Commands: BLANK, CLRW, SNGLS, TS

Example

10 OUTPUT 718;"IP;BLANK TRA"	<i>Initializes instrument.</i>
20 OUTPUT 718;"SNGLS;"	<i>Activates single-sweep mode.</i>
30 OUTPUT 718;"DET POS;CLRW TRB;TS;"	<i>Activates positive-peak detection of trace B.</i>
40 OUTPUT 718;"VIEW TRB;"	<i>Stores results and displays trace B.</i>
50 OUTPUT 718;"DET SMP;CLRW TRC;"	<i>Activates sample detection.</i>
60 OUTPUT 718;"TS;"	
70 OUTPUT 718;"VIEW TRC;"	<i>Stores results of sweep in trace C.</i>
80 OUTPUT 718;"BXC;"	<i>Exchanges trace B with trace C.</i>
90 OUTPUT 718;"BLANK TRB;"	<i>Blanks trace B leaving only trace C on screen.</i>
100 END	

Description

The BXC command exchanges the contents of traces B and C, then places both traces in the view mode.

To retain all data, trace B and trace C should contain a complete sweep of measurement data before BXC is executed.

BYPASS Bypass Path

Switches in and out of the bypass input path.

Syntax

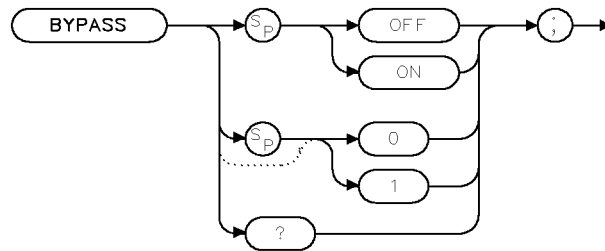

xbypass .

Equivalent Softkey: **INPUT 2 BYPASS**

Related Commands: RFIN, HAVE

Example

```
OUTPUT 718; "BYPASS ON:"
```

Description

The BYPASS command switches in and out of the bypass input path for INPUT 2 of the optional RF filter section.

- Note** An illegal command SRQ will be set if you issue the BYPASS command when:
- the optional RF filter section is not present and operational in the system, or
 - the optional RF filter section input path is set to INPUT 1 (9 kHz–50 MHz). INPUT 1 cannot be put into bypass.

Query Response

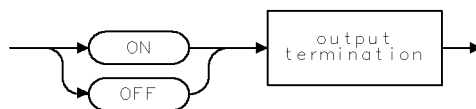

002 .

CAL

Calibration

Initiates self-calibration routines.

Syntax

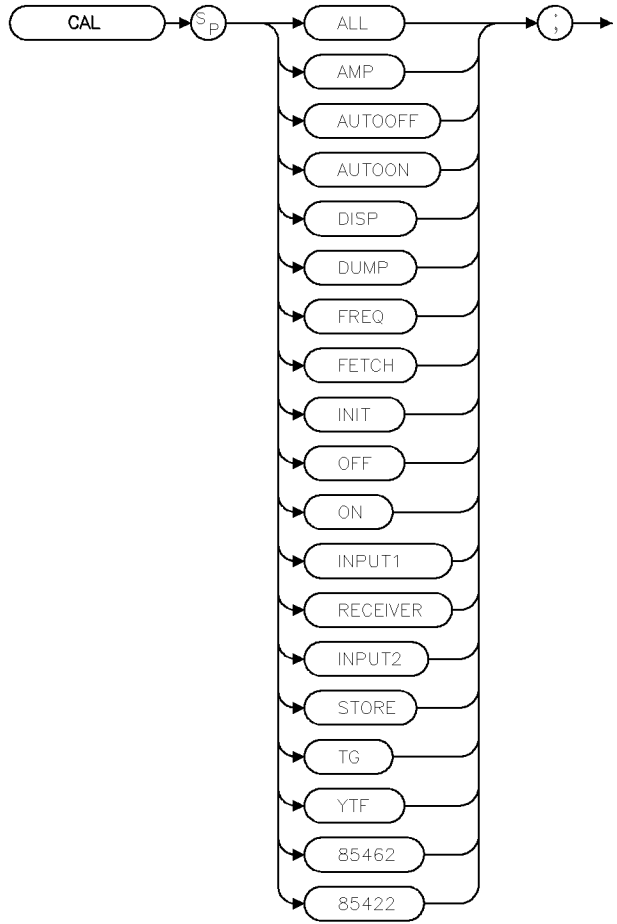

xcalib

Equivalent Key: softkeys accessed by **CALIBRATE**

Example

OUTPUT 718;"CAL FREQ;" *Performs the frequency correction routine.*

Description

The CAL command controls calibration functions. CAL initiates action according to the CAL parameters. The various parameters correspond to receiver softkeys as shown below.

ALL	initiates frequency and amplitude correction routines. It corresponds to <u>CAL ALL</u> for a full system calibration for the EMI receiver.
AMP	initiates the amplitude correction routine and corresponds to <u>CAL AMP</u> . This softkey is available for the receiver RF section only.
AUTOON	enables the AUTOCAL function.
AUTOOFF	disables the AUTOCAL function.
CALSW	measures the difference in amplitude between a calibrator signal attached to the receiver RF section RFIN connector and the calibrator signal routed through the internal switches to the RF attenuator input.
DISP	displays some of the correction factors on the receiver display.
DUMP	returns correction factors to the controller.
FETCH	recalls the correction factors from the “working” random-access memory. The “working” random-access memory is the section of memory that is accessed when the receiver is turned on. CAL FETCH corresponds to <u>CAL FETCH</u> .
FREQ	initiates the frequency correction routine and corresponds to <u>CAL FREQ</u> . This softkey is available for the receiver RF section only.
INIT	sets the calibration data back to predetermined values. CAL INIT corresponds to <u>DEFAULT CAL DATA</u> . Before executing CAL INIT, you must set the receiver’s center frequency –37 Hz to access this function. After a CAL INIT has been performed, you should perform CAL YTF (<i>For an HP 8546A/HP 85462A only</i>).
OFF	turns correction factors off and corresponds to <u>CORRECT ON OFF</u> (OFF is underlined). (See also “CORREK.”)
ON	turns correction factors on and corresponds to <u>CORRECT ON OFF</u> (ON is underlined). (See also “CORREK.”)
INPUT1	calibrates the receiver’s conducted measurement band, 9 kHz to 50 MHz, for amplitude flatness through each filter.
RECEIVER	performs a full receiver cal. receiver RF section CAL FREQ and AMP. External level loop cal and the two input calcs of the RF filter section). This parameter corresponds to <u>CAL ALL</u> .
INPUT2	calibrates the receiver’s radiated measurement band, 20 MHz to 2.9 GHz, for amplitude flatness through each filter.
STORE	moves the correction factors to an area of receiver memory that is accessed when the receiver is powered on. STORE corresponds to <u>CAL STORE</u> . The CAL STORE command cannot be executed if the correction data is not valid. Correction data is valid if <u>CORRECT ON OFF</u> (ON is underlined) causes CORR to be displayed on the receiver display. Executing the CAL STORE command with invalid data generates an SRQ 110.
85422	performs a calibration only on the HP 85422E receiver RF section when configured as an HP 8542E EMI receiver.

CAL Calibration

85462 performs a calibration only on the HP 85462A receiver RF section when configured as an HP 8546A EMI receiver.

Note Execute CAL STORE after successful completion of the self-calibration routines.

TG performs the tracking generator calibration routines. CAL TG corresponds to CAL TRK GEN .

Note Before executing the CAL TG command, a cable must be connected between the tracking generator output and the receiver input.

For an HP 8546A/HP 85462A only.

YTF initiates the correction routine for the YIG-tuned filter. The CAL YTF command corresponds to CAL YTF .

Refer to the *EMI Receiver Series User's Guide* for more information about the self-calibration routines, which includes the correct instrument setup for each routine.

CAL DISP and CAL DUMP do not return all of the correction factors because the number of characters that can be displayed on the receiver display is limited. CAL DUMP only returns the correction factors (as ASCII values) that would be displayed on the receiver display. Refer to the service guide for more information about displaying calibration data and reinitializing calibration data.

If the calibration data has been corrupted or is obviously inaccurate, use CAL FETCH to retrieve the calibration data that has been previously saved. If the calibration data fetched is corrupt, the following example can be used to set the calibration data back to predetermined values. Execute OUTPUT 718;"CF -37HZ;CAL INIT;", then perform the CAL AMP, CAL FREQ, or CAL ALL calibration routines. Use CAL STORE if the calibration routines have finished successfully.

Note Using the default calibration data may cause the calibration routine to fail. If this occurs, execute "OUTPUT 718;CF -37HZ;" before performing the CAL FREQ or CAL ALL calibration routines.

The take sweep (TS) and DONE commands can be used to indicate that the correction routine has finished. Query the CORREK command to check that the calibration routines have finished successfully.

CALCHECK Calibration Check

Performs a quick confidence check of the EMI receiver calibration.

Syntax

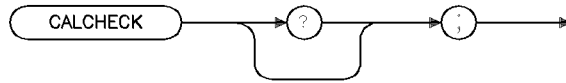

xcalck

Equivalent Key:

CAL CHECK

Example

```
OUTPUT 718; "CALCHECK;"
ENTER 718;A
DISP A
```

Description

The CALCHECK command performs a quick confidence check of the EMI receiver calibration and returns the result. The receiver RF section amplitude accuracy is tested at 300 MHz to assure ± 0.75 dBm accuracy relative to the calibrator signal level. If a RF filter section is present the system calibration data will be checked for validity.

A "0" is returned if calibration check fails, a "1" is returned if calibration check passes.

Query Response

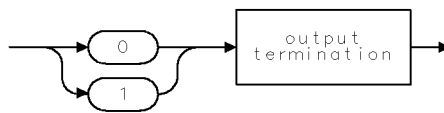

qgen1

CALSW Calibration Switch

Switches the 300 MHz calibrator signal.

Syntax

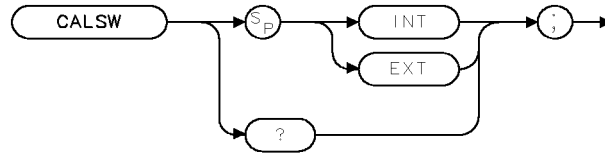

xcalsw . . .

Equivalent Softkey: **VIEW CAL ON OFF**

Preset Value: EXT

Related Commands: RFIN, CAL

Example

```
OUTPUT 718; "CALSW INT;"
```

Description

The CALSW command switches the 300 MHz calibrator signal so that it is routed internally to the instrument's input or externally to the instrument's 300 MHz output.

Query Response

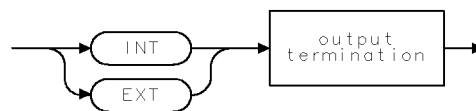

qcalsw . . .

CALTIME Calibration Time

Allows you to set the time of day of an automatic calibration.

Syntax

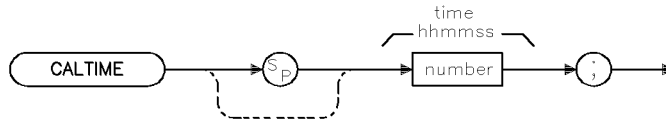

xctime

Item	Description/Default	Range
Number	A number in the HHMMSS (24 hour) format.	Valid hour, minutes, and seconds.

Equivalent Softkey: **SET TIME**

Related Commands: CAL AUTOON, CAL AUTOOFF, AUTOCAL

Example

OUTPUT 718; "CALTIME 141000;" *Sets the autocal time to 2:10 PM.*

Description

The CALTIME command allows you to set the time of day that an automatic calibration of the instrument or system will execute. The CALTIME command will not enable or disable the AUTOCAL function.

CAT Catalog

Catalogs either internal memory or the floppy disk.

Syntax

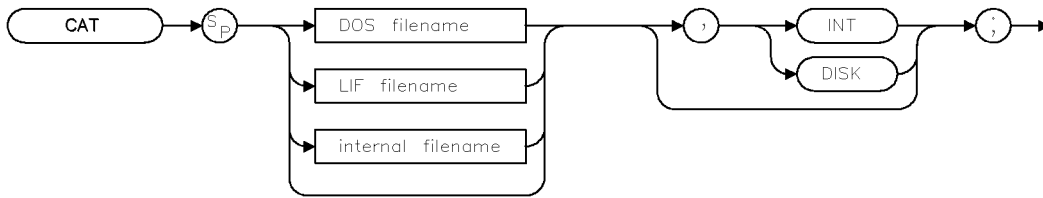

xcat

Where DOS filename is:

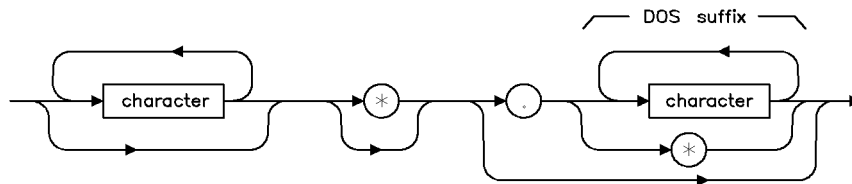

xcat1

Where LIF filename is:

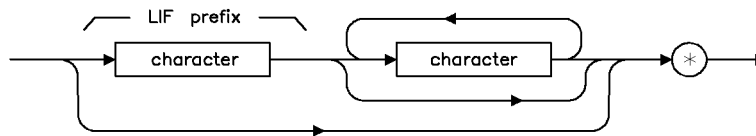

xcat2a

Where internal filename is:

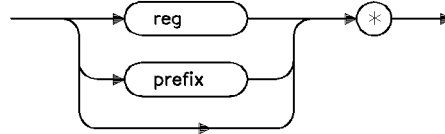

xcat3

Refer to Table 4-5 for a list of DOS suffixes and LIF prefixes..

Equivalent Softkeys: `Catalog Internal` or `CATALOG DISK`

Related Commands: `MSI, STOR, LOAD`

Example

This example returns the catalog information for the instrument setups stored on the floppy disk in DOS format. Catalog information is sent as individual catalog lines that are separated by a carriage return and a line feed. A carriage return, a line feed, and a line feed with an EOI (equivalent to a carriage return, a line feed, and a line feed) is asserted after the last item.

10	<code>DIM User\$ [2000],Catalog\$(1:100) [80]</code>	<i>Dimensions strings to store the catalog information. User\$ stores the entire string of catalog information. Catalog\$ stores the catalog information line by line (up to 100 lines and 80 characters long).</i>
20	<code>INTEGER I,Pos_lf</code>	<i>I and Pos_lf are used to search through User\$ string.</i>
30	<code>OUTPUT 718;"CAT *.ALL,DISK;"</code>	<i>The instrument sends catalog information for all the states stored on the floppy disk.</i>
40	<code>ENTER 718 USING "#,-K";User\$</code>	<i>Reads the catalog information into the User\$ string.</i>
50	<code>I=0</code>	
60	<code>WHILE LEN(User\$)>1</code>	<i>Loops until the User\$ string is empty.</i>
70	<code> I=I+1</code>	
80	<code> Pos_lf=POS(User\$,CHR\$(10))</code>	<i>Checks for line feeds. CHR\$(10) represents the line feed, the ASCII code for a line feed is "10."</i>
90	<code> Catalog\$(I)=User\$[1,Pos_lf-2]</code>	<i>Extracts catalog line.</i>
100	<code> OUTPUT CRT;Catalog\$(I)</code>	<i>Displays catalog line.</i>
120	<code> User%=User\$[Pos_lf+1]</code>	
130	<code>END WHILE</code>	
140	<code>END</code>	

CAT Catalog

Description

The CAT command catalogs either internal memory or the floppy disk and returns the catalog information to the controller.

To use the CAT command, you must specify the type of information to be cataloged and either the internal memory or the floppy disk as the catalog source. After the instrument has sent the catalog information to the controller, the instrument sends two line feed characters to the controller.

Specifying the type of information: The types of information that can be cataloged depend on the source. See the following sections, “Cataloging the Floppy Disk” and “Cataloging Internal Memory” for more information.

Specifying the source: You can specify the internal memory or the floppy disk as the source by specifying INT or DOS respectively. If source (INT) is omitted, the default is the current mass storage device. See “MSI” for more information about setting the current mass storage device.

Note When CAT is executed from a remote port, the catalog information is sent to the remote port and is not displayed on the screen.

Cataloging the Floppy Disk

When cataloging a floppy disk, you can specify the type of information to be cataloged, in either LIF or DOS format. Specify a prefix for LIF format or a suffix for DOS format to indicate the data type (see the following table). For example, if you execute “CAT l*,DISK;” all of the limit line files on a LIF formatted floppy disk will be returned, executing “CAT *.LIM,DISK;” all of the limit line files on a DOS formatted floppy disk will be returned. The file prefix or suffix corresponding to the data types are as follows:

Table 4-5. LIF or DOS File Types

LIF Prefix	DOS Suffix	File Description
s	STA	Instrument state
t	TRC	Trace
l	LIM	Limit lines
i	BMP	Display image file
g	SIG	Signal list
n	ANT	Antenna correction factors
c	CBL	Cable correction factors
o	OTH	Other correction factors
e	ALL	All information

CAT returns the directory information only if a file has been found.

Cataloging Internal Memory

When cataloging internal memory, you can use “reg” or “prefix” to specify information to be cataloged.

- prefix* Catalogs the variables in internal memory according to the current prefix. (Use `Change Prefix` or `PREFIX` to change the current prefix.)
- reg* Catalogs the contents of the state and trace registers. The center frequency and span of the state registers are displayed; the title and date of the trace registers are displayed.
- * Catalogs all the variables stored in internal memory, but does not return the contents of the state and trace registers.

Cataloging instrument (internal) memory returns the following information:

- MSI device (internal).
- Bytes of internal memory used.
- Total amount of internal memory (in bytes). This number includes the amount of internal memory in use and the amount of internal memory available.
- Name of the stored data and the number of bytes used.

Note The difference between the bytes of internal memory used and the total internal memory available is the amount of internal memory available.

CF

Center Frequency

Specifies the center frequency.

Syntax

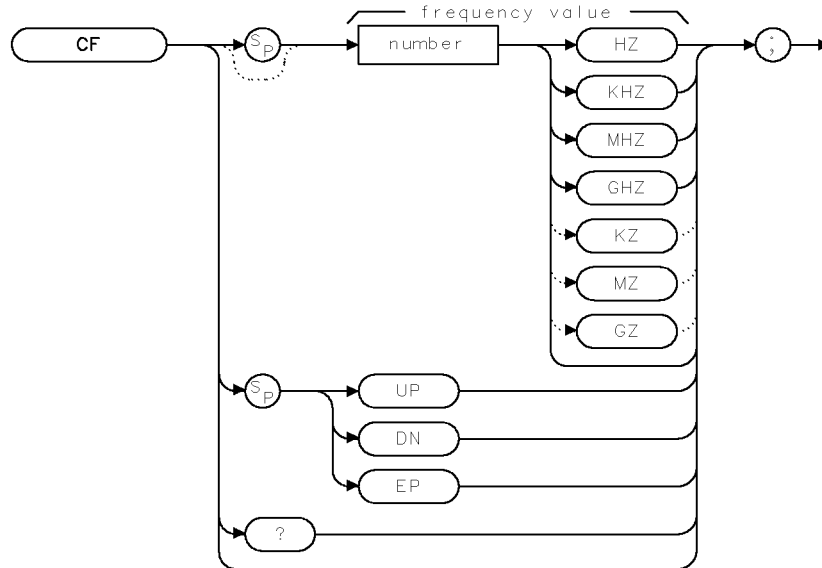

XCF

Item	Description/Default	Range
Number	Any real or integer number. Default unit is Hz.	Frequency range of the instrument.

Equivalent Softkey: **CENTER FREQ**

Step Increment: If uncoupled, step size is determined by the SS command. If coupled, step size is 10% of span.

Related Commands: HNLOCK, FA, FB, FOFFSET, FS, MKCF, MKSS, SP, SS

Note Although the instrument allows entry of frequencies not in the specified frequency range, using frequencies outside the frequency span of the instrument is not recommended and is not warranted to meet specifications.

Example

OUTPUT 718;"CF 300MHZ;" *Sets the center frequency to 300 MHz.*

Description

The CF command specifies the value of the center frequency.

Query Response

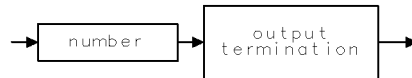

QQ1

CLRAVG

Clear Average

Restarts video averaging.

Syntax

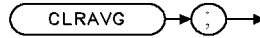

XCLRAVG .

Related Commands: AMB, CLRW, MINH, MXMH, VAVG

Example

```
OUTPUT 718;"IP;"            Initializes the instrument.
OUTPUT 718;"VAVG 100;"    Initializes video averaging.
WAIT 30
OUTPUT 718;"CLRAVG;"      Restarts video averaging.
```

Description

The CLRAVG command restarts the VAVG command by resetting the number of averaged sweeps to one. The video averaging routine resets the number of sweeps, but does not stop video averaging. Use "VAVG OFF;" to stop video averaging.

CLRW Clear Write

Clears the specified trace and enables trace data acquisition.

Syntax

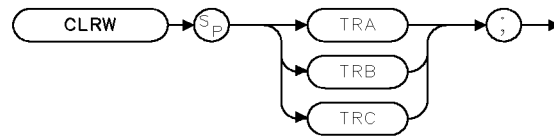

XCLRW

Equivalent Softkeys: CLEAR WRITE A , CLEAR WRITE B , and CLEAR WRITE C

Preset State: CLRW TRA

Related Commands: BLANK, DET, MINH, MXMH, VAVG, VIEW

Example

```
OUTPUT 718;"CLRW TRA;"
```

Description

The CLRW command places the indicated trace in the clear-write mode. Data acquisition begins at the next sweep. (See "TS" for more information about data acquisition.)

CLS

Clear Status Byte

Clears all status bits.

Syntax

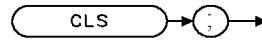

XCLS

Related Commands: RQS, SRQ, STB

Example

```
OUTPUT 718;"CLS;"
```

Description

The CLS command clears all the status bits in the status byte. (See “SRQ” for more information on the status byte.)

CNTLA Auxiliary Interface Control Line A

Sets the control line A of the auxiliary interface high or low.

Syntax

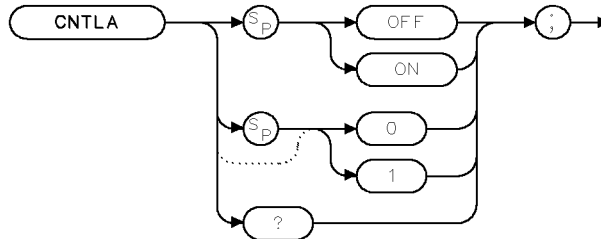

XCNTLA

Equivalent Softkey: `CNTL A 0 1`

Related Commands: CNTLB, CNTLC, CNTLD, CNTLI

Example

```
OUTPUT 718;"CNTLA ON;"   Sets control line A high.
OUTPUT 718;"CNTLA?;"    Queries the state of control line A.
ENTER 718;A$            Gets the response from the instrument.
DISP A$                 Displays the response.
```

Description

CNTLA ON sets control line A to high, CNTLA OFF sets it to low (the auxiliary interface connector outputs use transistor-transistor logic).

Note This command is not accessible if the RF filter section is present.

Query Response

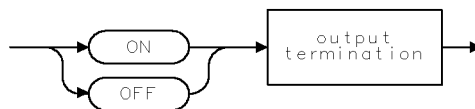

QQ2

CNTLB Auxiliary Interface Control Line B

Sets the control line B of the auxiliary interface high or low.

Syntax

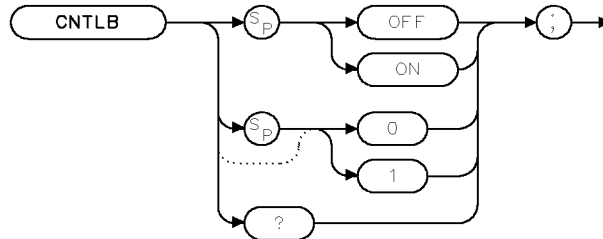

XCNTLB

Equivalent Softkey: `CNTL B 0 1`

Related Commands: CNTLA, CNTLC, CNTLD, CNTLI

Example

```
OUTPUT 718;"CNTLB ON;"  Sets control line B high.
OUTPUT 718;"CNTLB?;"    Queries the state of control line B
ENTER 718;A$             Gets the response from the instrument.
DISP A$                  Displays the response.
```

Description

CNTLB ON sets control line B to high, CNTLB OFF sets it to low (the auxiliary connector outputs use transistor-transistor logic).

Note This command is not accessible if the RF filter section is present.

Query Response

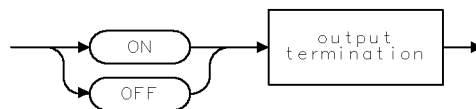

Q02

CNTLC Auxiliary Interface Control Line C

Sets the interface control line C of the auxiliary interface high or low.

Syntax

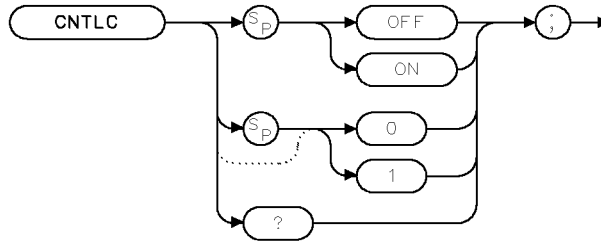

Equivalent Softkey: `CNTL C 0 1`

Related Commands: CNTLA, CNTLB, CNTLD, CNTLI

Example

```
OUTPUT 718;"CNTLC ON;"   Sets control line C high.
OUTPUT 718;"CNTLC?;"    Queries the state of control line C.
ENTER 718;A$             Gets the response from the instrument.
DISP A$                  Displays the response.
```

Description

CNTLC ON sets control line C to high, CNTLC OFF sets it to low (the auxiliary interface connector outputs use transistor-transistor logic).

Note This command is not accessible if the RF filter section is present.

Query Response

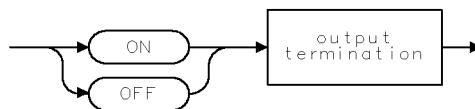

CNTLD

Auxiliary Interface Control Line D

Sets the interface control line D of the auxiliary interface high or low.

Syntax

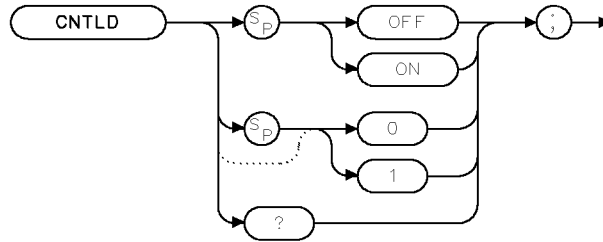

XCNTLD

Equivalent Softkey: `CNTL D 0 1`

Related Commands: CNTLA, CNTLB, CNTLC, CNTLI

Example

```

OUTPUT 718;"CNTLD ON;"   Sets control line D high.
OUTPUT 718;"CNTLD?;"    Queries the state of control line D.
ENTER 718;A$             Gets the response from the instrument.
DISP A$                  Displays the response.
  
```

Description

CNTLD ON sets control line D to high, CNTLD OFF sets it to low (the auxiliary connector outputs use transistor-transistor logic).

Note This command is not accessible if the RF filter section is present.

Query Response

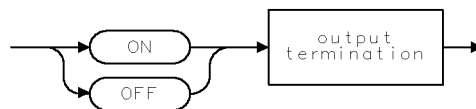

Q02

CNTLI Auxiliary Interface Control Line Input

Returns a “1” when the interface control line I of the auxiliary interface is high, and “0” if the line input is low.

Syntax

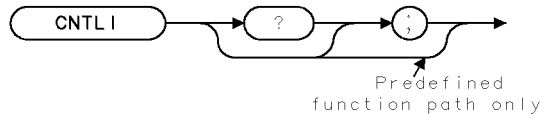

XCNTLI

Equivalent Softkey: **DISPLAY CNTL I**

Related Commands: CNTLA, CNTLB, CNTLC, CNTLD

Example

OUTPUT 718;"CNTLI;" *Gets the status of control line I.*

ENTER 718;A

DISP A *Displays status.*

Description

The CNTLI command returns a “1” when the interface control line I of the auxiliary interface is high, and “0” if the line input is low.

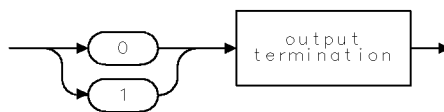

qgen1

COMPRESS

Compress Trace

Reduces the number of trace elements.

Syntax

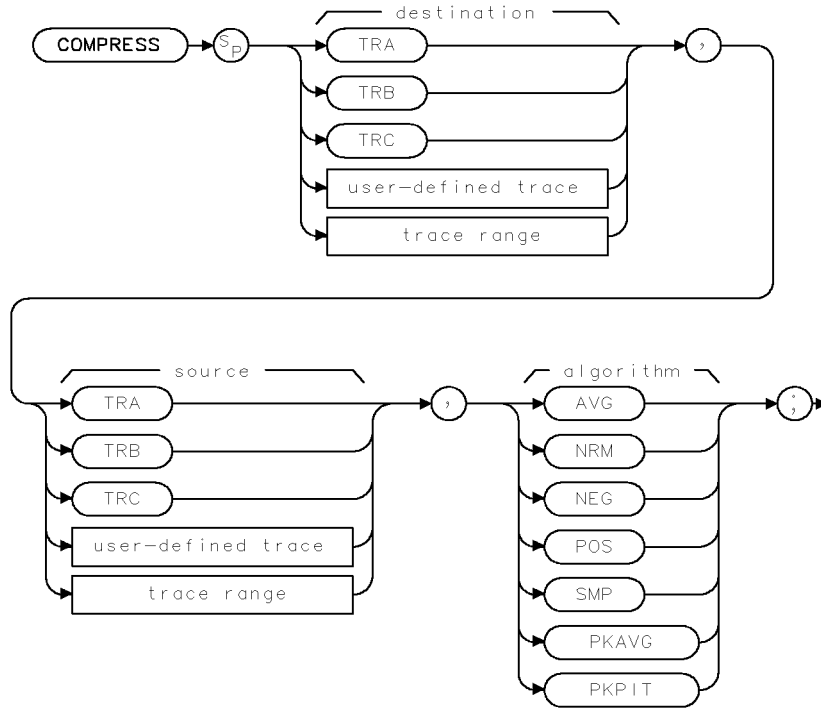

XCOMPRESS

Item	Description/Default	Range
User-defined trace	A trace defined by the TRDEF command	Any valid trace name.
Trace Range	A segment of trace A, trace B, trace C, or a user-defined trace.	

Prerequisite Commands: TRDEF when using user-defined trace. TS when using trace data.

Example

This example compresses trace B into “C_OMPTRAC” using the positive (POS) algorithm.

10 OUTPUT 718;"IP;"	<i>Initializes instrument.</i>
20 OUTPUT 718;"TRDEF C_OMPTRAC,100;"	<i>Creates a trace called C_OMPTRAC with a length of 100 elements.</i>
30 OUTPUT 718;"BLANK TRA;SNGLS;"	<i>Blanks trace A, activates single-sweep mode.</i>
40 OUTPUT 718;"CLRW TRB;TS;"	<i>Measures with trace B.</i>
50 OUTPUT 718;"COMPRESS C_OMPTRAC,TRB,POS;"	<i>Compresses trace B into C_OMPTRAC.</i>
60 OUTPUT 718;"BLANK TRB;"	<i>Blanks trace B.</i>

<pre>70 OUTPUT 718;"MOV TRA,C_OMPTRAC;" 80 OUTPUT 718;"VIEW TRA;" 90 END</pre>	<p><i>Moves C_OMPTRAC into trace A.</i></p> <p><i>Displays the result.</i></p>
--	--

Description

The COMPRESS command reduces the number of trace elements while retaining the relative frequency and amplitude characteristics of the trace data. It stores a compressed copy of the source trace into a smaller destination trace. The source trace is divided into the same number of intervals as there are points in the destination trace, and the data within each interval are compressed into the value for the corresponding destination trace point. The algorithm used to compress the data is given as an parameter to the command.

The algorithms available are as follows:

- AVERAGE (AVG) The average of the points within an interval is used.
- NORMAL (NRM) NRM computes the compressed value of the interval by using a rosenfell algorithm. The rosenfell algorithm is a mathematical operation defined in instrument firmware. The algorithm compresses a locally continuously rising or falling signal into the peak value detected in each interval. If the detected signal is not continuously rising or falling, then the data value alternates between minimum and maximum in the compressed interval. This shows the peak-to-peak noise variations. The rosenfell option is useful for accurately displaying noise, because peak detection can give misleading representation of noise.
- NEGATIVE (NEG) The lowest value in each interval is used.
- POSITIVE (POS) Specifying POS selects the highest point in the interval as the compressed value.
- SAMPLE (SMP) Specifying SMP selects the last point in the interval as the compressed value.
- PEAK AVERAGE (PKAVG) The PKAVG algorithm selects the difference between the peak and the average value of the interval as the compressed value.
- PEAK PIT (PKPIT) The PKPIT algorithm returns the difference between the positive and the negative peaks within the interval.

CONCAT

Concatenate

Combines two traces.

Syntax

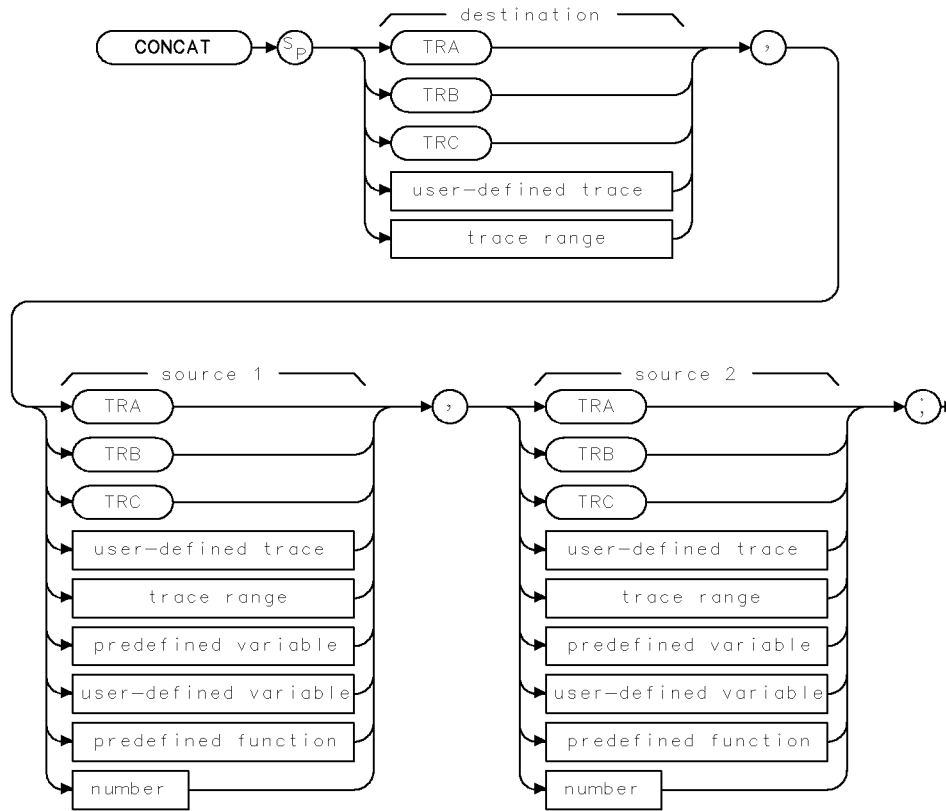

XCONCAT .

Item	Description/Default	Range
User-defined trace	A trace defined by the TRDEF command.	Any valid trace name.
User-defined variable	A variable defined by VARDEF command.	Any valid variable name.
Predefined variable	A command that acts as a variable. Refer to Table 4-1.	
Predefined function	Function that return a value. Refer to Table 4-1.	
Trace Range	A segment of trace A, trace B, trace C, or a user-defined trace.	
Number	Any real or integer number.	Real number range.

Prerequisite Commands: TRDEF when using a user-defined trace. VARDEF when using a user-defined variable. TS when using trace data.

Related Commands: MOV, VIEW

Example

10 OUTPUT 718;"IP;"	<i>Initializes the instrument.</i>
20 OUTPUT 718;"SNGLS;"	<i>Activates the single-sweep mode.</i>
30 OUTPUT 718;"TS;VIEW TRA;"	<i>Stores and displays trace A.</i>
40 OUTPUT 718;"CLRW TRB;TS;"	<i>Takes a measurement sweep with trace B.</i>
50 OUTPUT 718;"CONCAT TRC,TRA[1,200],TRB[201,401];"	<i>Concatenates the last half of trace B to the first half of trace A.</i>
60 OUTPUT 718;"BLANK TRA;BLANK TRB;"	<i>Blanks trace A and trace B.</i>
70 OUTPUT 718;"VIEW TRC;"	<i>Displays the result.</i>
80 END	

Description

The CONCAT command concatenates source 2 to the end of source 1, then stores the result in the destination. If the destination length is less than the length of source 1 and source 2, the list is truncated. For example, executing "CONCAT TRA[1,15],TRB[3,6],TRB[7,207];" results in trace A elements 1 to 4 being replaced by trace B elements 3 to 6, and trace A elements 5 to 15 being replaced by trace B elements 7 to 17. Trace B elements 18 to 207 are ignored. If necessary, reduce trace lengths with the COMPRESS command.

If the length of the destination is greater than the length of source 1 and source 2, the last value is repeated. For example, executing "CONCAT TRA[1,15],TRB[3,6],TRB[7,9];" results in trace A elements 1 to 4 being equal to trace B elements 3 to 6, trace A elements 5 and 6 being replaced by trace B elements 7 and 8, and trace A elements 7 to 15 being replaced by trace B element 9.

CONTS

Continuous Sweep

Sets the instrument to the continuous sweep mode.

Syntax

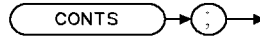

XCONTS

Equivalent Softkey: SWEEP CONT SGL (when CONT is underlined)

Preset State: CONTS

Related Commands: SNGLS, ST, TM

Example

```
OUTPUT 718;"CONTS;"
```

Description

The CONTS command sets the instrument to continuous sweep mode. In the continuous sweep mode, the instrument takes its next sweep as soon as possible after the current sweep (as long as the trigger conditions are met). A sweep may temporarily be interrupted by data entries made from the front panel or over the remote interface.

CORREK Correction Factors On

Returns status of the correction factors.

Syntax

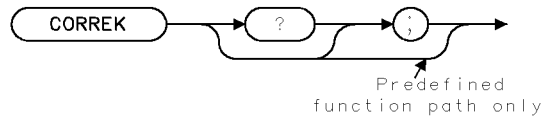

XCORREK .

Equivalent Softkey: `CORRECTN ON OFF`

Related Commands: CAL

Example

```

OUTPUT 718;"CORREK;"
ENTER 718;A
DISP A
  
```

Description

The CORREK command returns a "1" if the correction factors are on, a "0" if they are off.

Note CORREK OFF will also disable AMPCOR amplitude correction. However, CORREK ON will not enable AMPCOR amplitude correction.

Query Response

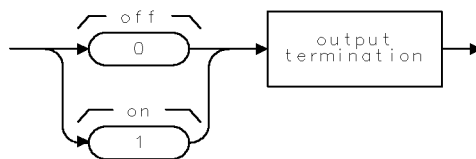

003 .

COUPLE

Couple

Selects direct-current (dc) coupling or alternating-current (ac) coupling.

Syntax

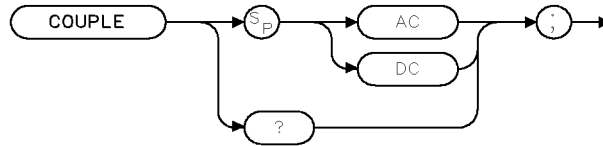

XCOUPLE .

Equivalent Softkey: `COUPLE AC DC`

Preset State: AC

Related Commands: IP

Example

```
OUTPUT 718;"COUPLE DC;"
```

Description

The COUPLE command selects direct-current (dc) coupling or alternating-current (ac) coupling.

CAUTION Do not use dc coupling if there is *any* dc voltage at the instrument input. Do not exceed the power stated on the instrument input. See the specifications for the instrument in the Calibration Guide for your instrument for more information.

If there is no dc voltage at the instrument input, dc coupling is useful for observing low frequency signals at the instrument input. Use ac coupling when there is dc voltage at the instrument input (ac coupling blocks the dc voltage and allows only the ac voltage at the instrument input).

When used as a predefined variable, COUPLE returns a "0" if COUPLE has been set to DC, a "1" if COUPLE has been set to AC.

Query Response

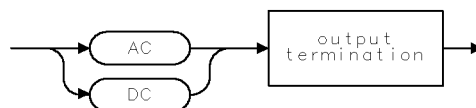

QCOUPLE .

CTA Convert to Absolute Units

Converts the source values from measurement units to the current absolute amplitude units.

Syntax

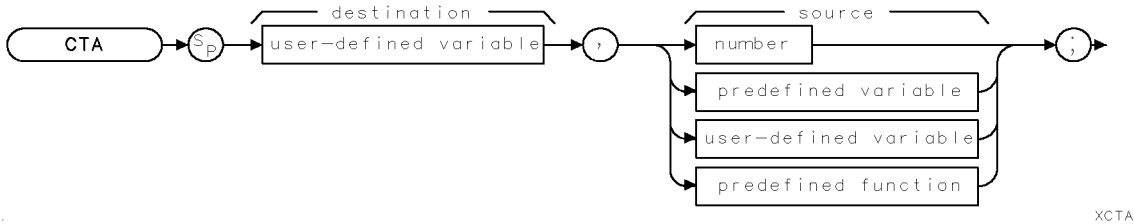

Item	Description/Default	Range
User-defined variable	A variable defined by VARDEF command.	Any valid variable name.
Number	Any valid integer number.	-32,768 to +32,767.
Predefined variable	A command that acts as a variable. Refer to Table 4-1.	
Predefined function	Function that return a value. Refer to Table 4-1.	

Prerequisite Commands: VARDEF when using a user-defined variable

Related Commands: AUNITS, LG, LN, RL

Example

```

10 OUTPUT 718;"VARDEF C_ONLV,0;"   Declares a variable called C_ONLV.
20 OUTPUT 718;"LG;"               Puts the instrument in log mode.
30 OUTPUT 718;"RL 80DB;"          Changes the reference level.
40 OUTPUT 718;"CTA C_ONLV, 8000;" Stores 80 in C_ONLV.
50 OUTPUT 718;"RL 70DB;"          Changes the reference level.
60 OUTPUT 718;"CTA C_ONLV,8000;"  Stores 70 in C_ONLV.
70 OUTPUT 718;"C_ONLV?;"
80 ENTER 718;A
90 DISP A
100 END

```

CTA Convert to Absolute Units

Description

The CTA command converts the source values from measurement units to the current absolute units and then stores the results in the destination.

The result of the CTA command depends on the reference level, the current amplitude units, and the amplitude scale (log or linear).

Measurement units are the internal binary data representation of measured results. The internal binary data representation is 16-bit amplitude values that are stored in traces. The values range from $-32,768$ to $32,767$. The value of 8000 corresponds to an amplitude equal to the reference level. In log mode, each count represents 0.01 dB. A signal 0.01 dB above the reference level is at 8001 , and signal 1.0 dB below the reference level is at 8000 minus 100 , or 7900 . In linear mode, 8000 is the reference level and 0 is the 0 volt level. If the reference level is at 80 mV, each count would represent 0.080 divided by 8000 or 10 μ V, but a reference level of 2.4 volts would represent 2.4 divided by 8000 or 300 μ V per count.

CTM Convert to Measurement Units

Converts the source values to measurement units.

Syntax

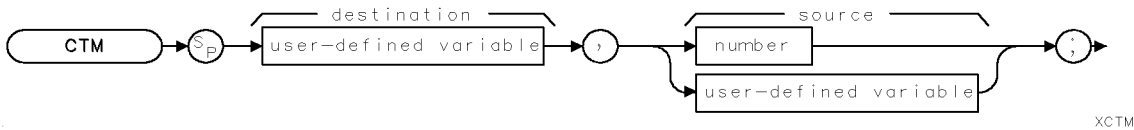

Item	Description/Default	Range
User-defined variable	A variable defined by VARDEF command.	Any valid variable name.
Number	A number expressed in integer, decimal, or exponential form.	Real number range.

Prerequisite Commands: VARDEF when using a user-defined variable

Related Commands: AUNITS, CTA, LG, LN, RL

Example

```

OUTPUT 718;"VARDEF A_MPV,0;"  Declares a variable called A_MPV.
OUTPUT 718;"LG;"             Puts the instrument in log mode.
OUTPUT 718;"RL 70DB;"       Changes the reference level.
OUTPUT 718;"CTM A_MPV,70;"  Stores 8000 in A_MPV.
    
```

Description

The CTM command converts the source values to measurement units and places the result in the destination.

The result of the CTM command depends on the reference level, the current amplitude units, and the amplitude scale (log or linear).

Measurement units are the 16-bit amplitude values stored in traces. The values range from -32,768 to 32,767. The value of 8000 corresponds to an amplitude equal to the reference level. In log mode, each count represents 0.01 dB. A signal 0.01 dB above the reference level is at 8001, and a signal 1.0 dB below the reference level is at 8000 minus 100, or 7900. In linear mode, 8000 is the reference level and 0 is the 0 volt level. If the reference level is at 80 mV, each count would represent 0.080 divided by 8000 or 10 μ V, but a reference level of 2.4 volts would represent 2.4 divided by 8000 or 300 μ V per count.

DATEMODE

Date Mode

Sets the format for displaying the real-time clock.

Syntax

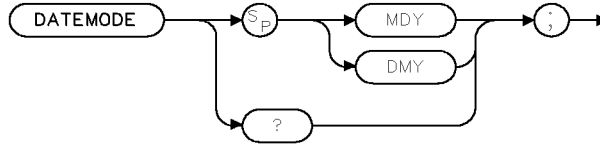

XDATEMODE

Equivalent Softkey: `DATEMODE MDY DMY`

Example 1

```
OUTPUT 718;"DATEMODE DMY;"   Sets the date mode to day, month, year format.
OUTPUT 718;"DATEMODE?;"     Queries the format of the display of the real-time clock.
ENTER 718;A$
DISP A$
```

Example 2

```
OUTPUT 718;"VARDEF T_EMP,0;"   Creates a variable.
OUTPUT 718;"DATEMODE DMY;"   Sets the date mode to day, month, year format.
OUTPUT 718;"MOV T_EMP,DATEMODE?;" Queries the format of the display of the real-time clock as a predefined variable.

OUTPUT 718;"T_EMP?;"         Gets the result.
ENTER 718;A
DISP A
```

Description

The DATEMODE command sets the format for displaying the real-time clock in either the month, day, year format or day, month, year format.

When used as a predefined variable, DATEMODE returns a "0" if DATEMODE has been set to MDY, a "1" if DATEMODE has been set to DMY. See example 2.

Query Response

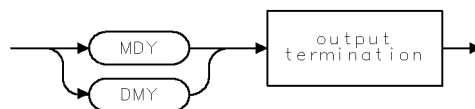

QDATEMODE

DEMODO Demodulation

Turns the demodulator on or off, and selects between AM, FM, or quasi-peak demodulation.

Syntax

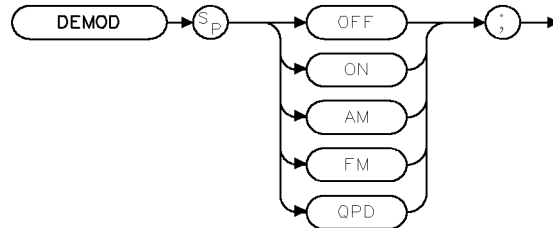

XDEMODO

Equivalent Softkey: `DEMODO ON OFF`

Related Commands: DET, FMGAIN, HAVE, MKPAUSE, SP, SPEAKER, SQLCH

Example

This example demonstrates FM demodulation in a span greater than zero.

10 OUTPUT 718;"IP;FA 90MHZ;"	<i>Sets start frequency.</i>
20 OUTPUT 718;"FB 110MHZ;"	<i>Sets stop frequency.</i>
30 OUTPUT 718;"TS;MKPK HI;MKCF;"	<i>Places marker on the highest peak and brings the peak to center frequency.</i>
40 OUTPUT 718;"DEMODO ON;DEMODO FM;"	<i>Turns on FM demodulation.</i>
50 OUTPUT 718;"MKPAUSE 500MS;"	<i>Turns on marker pause. The detector switches automatically to the FMV detector during the dwell time.</i>
60 END	

Description

Execute "DEMODO ON;" to turn on the demodulator. "DEMODO AM;" , "DEMODO FM;" , or "DEMODO QPD;" selects the demodulation mode, but does not turn on the demodulator.

For AM or FM demodulation in nonzero frequency spans, use MKPAUSE to set the dwell time of the marker.

DET Detection Mode

Selects the instrument detection mode.

Syntax

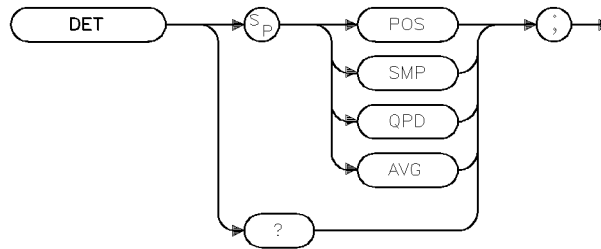

Equivalent Softkey: **DETECTOR SMP PK**
Preset State: DET POS
Related Commands: DEMOD, MEANTH, TV

Example

10 OUTPUT 718;"IP;"	<i>Initializes the instrument.</i>
20 OUTPUT 718;"SNGLS;"	<i>Activates single-sweep mode.</i>
30 OUTPUT 718;"DET POS;TS;"	<i>Activates the positive-peak detection of trace A.</i>
40 OUTPUT 718;"VIEW TRA;"	<i>Stores results in trace A.</i>
50 OUTPUT 718;"DET SMP;"	<i>Activates sample detection for trace B.</i>
60 OUTPUT 718;"CLRWB TRB;TS;"	<i>Measures with trace B.</i>
70 OUTPUT 718;"VIEW TRB;"	<i>Stores results in trace B.</i>
80 OUTPUT 718;"AVG TRA,TRB,2;"	<i>Averages trace A and B with a ratio of 2, and stores the results in trace A.</i>
90 OUTPUT 718;"BLANK TRB;"	<i>Blanks trace B, leaving only averaged results on screen.</i>
100 END	

Description

The DET command selects the type of instrument detection (positive-peak, sample, quasi-peak, or average) and accesses service-diagnostic detection functions.

- **POS** enables positive-peak detection, which displays the maximum video signal detected over a number of instantaneous samples for a particular frequency.
- **SMP** enables sample detection, which uses the instantaneous video signal value. Video averaging and noise-level markers, when activated, activate sample detection automatically.
- **QPD** switches the active detector to the quasi-peak detector.
- **AVG** switches the active detector to the average detector.

DET Detection Mode

When used as a predefined variable, DET returns a number. The number that is returned corresponds to the DET parameter as shown in the following table.

DET Parameter Setting	Value DET Returns
POS	1
SMP	0
QPD	45
AVG	58

Query Response

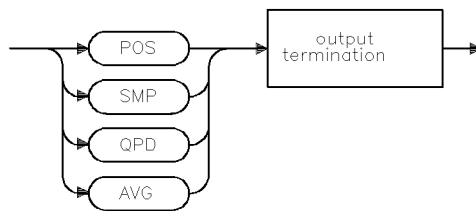

qdet

DISPOSE

Dispose

Frees internal memory that was previously allocated for user-defined operands.

Syntax

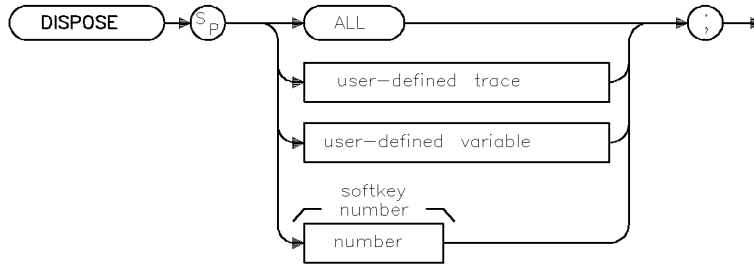

XDISPOSE

Item	Description/Default	Range
User-defined trace	A trace defined by the TRDEF command.	Any valid trace name.
User-defined variable	A variable defined by the VARDEF .	Any valid variable name.
Number	Any valid softkey number.	1 to 6, 601 to 1200.

Equivalent Softkey: `DISPOSE USER KEY`

Prerequisite Commands: TRDEF when using a user-defined trace. VARDEF when using a user-defined variable.

Related Commands: ERASE, LIMIDEL,

Example

OUTPUT 718;"VARDEF T_EMP,10;" *Defines a variable for use in a program. When the variable is no longer needed, it can be deleted using the DISPOSE command*

OUTPUT 718;"DISPOSE T_EMP;" *Deletes T_EMP from instrument memory.*

Description

The DISPOSE command frees internal memory that was previously allocated for user-defined operands. Using the TRDEF, VARDEF, programming commands create a trace, variable, that remains in the instrument's memory until you delete it with the DISPOSE command, or execute the ERASE command. With the DISPOSE command, you can select which item is to be deleted. Or, if you execute DISPOSE ALL, all of the traces, variables, functions, softkeys that have created will be deleted from internal memory. Executing "DISPOSE ALL;" or the ERASE command frees all available internal memory (except the state registers and predefined traces), to make the total available user-allotted memory the maximum size.

DIV Divide

Divides source 1 by source 2 and places the result in the destination.

Syntax

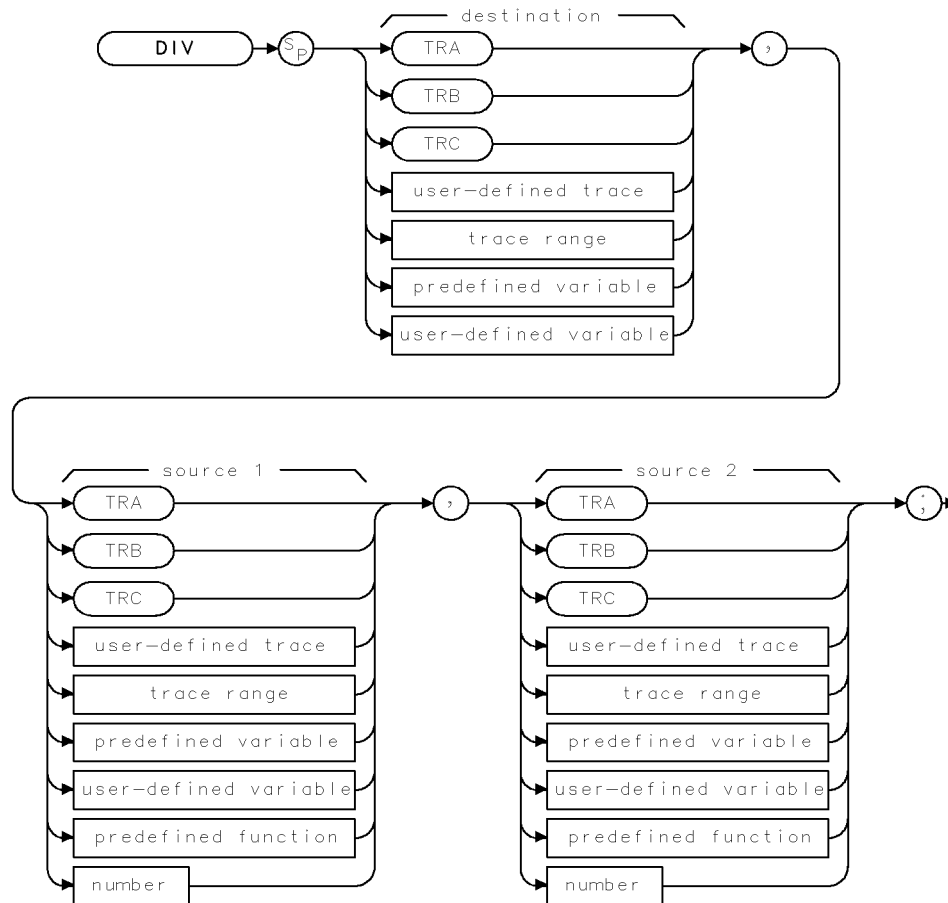

XDIV

Item	Description/Default	Range
User-defined trace	A trace defined by the TRDEF command.	Any valid trace name.
User-defined variable	A variable defined by VARDEF command.	Any valid variable name.
Predefined variable	A command that acts as a variable. Refer to Table 4-1.	
Predefined function	Function that returns a value. Refer to Table 4-1.	
Trace range	A segment of trace A, trace B, trace C, or a user-defined trace.	
Number	Any real or integer number.	Real number range.

Prerequisite Commands: TRDEF when using a user-defined trace. VARDEF when using a user-defined variable. TS when using trace data.

Related Commands: MPY, SNGLS, TS

DIV Divide

Example

OUTPUT 718;"IP;"	<i>Initializes the instrument.</i>
OUTPUT 718;"SNGLS;"	<i>Activates single-sweep mode.</i>
OUTPUT 718;"TS;"	<i>Updates trace information.</i>
OUTPUT 718;"DIV TRB,TRA,2;"	<i>Divides trace A by two and places it in trace B.</i>
OUTPUT 718;"VIEW TRB;"	<i>Displays the result.</i>

Description

The DIV command divides source 1 by source 2 and places the result in the destination. Integer values are used when a trace is either the destination or one of the sources. If trace data is used both as the source and the destination, the DIV function is done with 32-bit arithmetic on 16-bit integer data. If a user-defined variable or predefined variable is used as either the source or the destination, the DIV function is done in floating-point format. If a real number is used as a source, but the destination is an integer value, the result is truncated. If a trace is used as a source, be sure the trace contains a complete sweep of measurement information before executing DIV.

When the source is longer than the destination, the source is truncated to fit. When the source is shorter than the destination, the last element is repeated to fill the destination.

The results of the DIV function are invalid if source 2 is equal to zero.

DL Display Line

Defines the level of the display line in active amplitude units.

Syntax

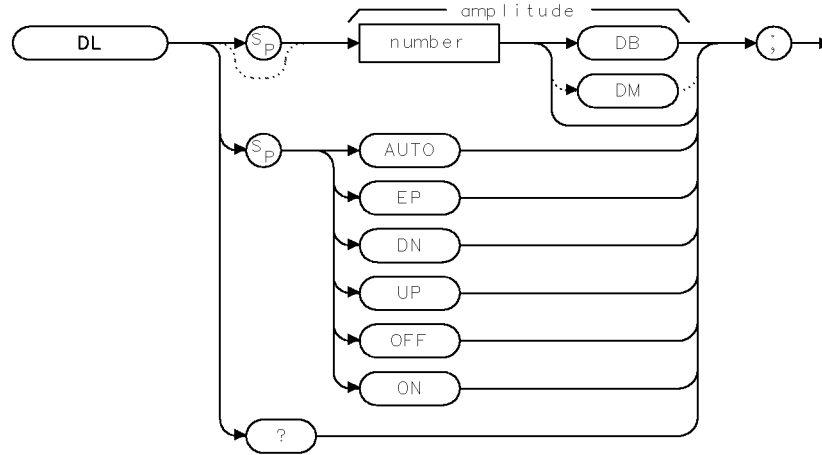

XDL

Item	Description/Default	Range
Number	Any real or integer number. Default units are dBm.	Dependent on the reference level.

Equivalent Softkey: **DSP LINE ON OFF**

Preset State: DL OFF

Step Increment: 1 major division

Related Commands: AUNITS, AUTO, LG, LN, NRL, RL, ROFFSET, TH

Example

OUTPUT 718;"DL ON;" *Turns on the display line.*

OUTPUT 718;"DL 80DB;" *Changes display line to 80 dB μ V*

DL Display Line

Description

The DL command defines the level of the display line in active amplitude units and displays the display line on the screen. Activating video trigger mode activates the display line. The AUTO command and “DL OFF;” turn off the display line. See “AUNITS” for more information on changing the active amplitude units.

Query Response

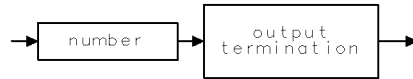

001

DN Down

Reduces the active function by the applicable step size.

Syntax

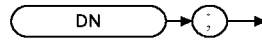

XDN

Related Commands: See the list of active functions listed in the description for DN

Example

```

OUTPUT 718;"SS 1MHZ;CF 999 MHZ;DN;"   Sets center frequency to 999 MHz.
OUTPUT 718;"SP 40MHZ;MKPK;DN;"       Decreases the frequency span.
  
```

Description

The DN command reduces the active function by the applicable step size. Before executing DN, be sure that the function to be decreased is the active function. For example, the second line of the programming example decreases the span, because marker peak (MKPK) is not an active function.

The active functions are: AT, AVBW, CF, DL, FA, FB, FMGAIN, IFBW, LG, MKA, MKD, MKFCR, MKN, MKPAUSE, MKPX, ML, NRL, RB, RCLS, ROFFSET, RL, RLPOS, SAVES, SETDATE, SETTIME, SP, SQLCH, SRCALC, SRCAT, SRCPOFS, SRCPSWP, SRCPWR, SRCTK, SS, ST, TH, VB, VBR.

DONE

Done

Determines when the instrument has separated the instrument commands and has started to execute all commands prior to and including DONE.

Syntax

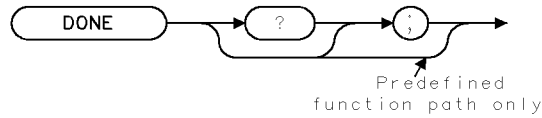

XDONE

Related Commands: TS

Example

```
OUTPUT 718;"IP;SNGLS;CF 1GHZ;SP 1GHZ;DONE;"
```

Because TS does not precede the DONE command in this line, the center frequency and span values are set before DONE returns a "1." Functions coupled to SP, such as RB, have not been changed, and there is no trace data associated with the new frequency settings.

```
ENTER 718;Done  
DISP Done
```

Example 2

```
OUTPUT 718;"IP;SNGLS;CF 1GHZ;SP 1GHZ;TS;DONE;"
```

Because the take sweep (TS) must be completed before the DONE command is executed, the autocoupled functions and trace data have been changed before the DONE command is executed.

```
ENTER 718;Done
```

Stores 1 in computer variable, called Done.

```
DISP Done
```

Description

The DONE command determines when the instrument has separated the instrument commands and has started to execute all commands prior to and including DONE. The instrument returns a value of “1” when all commands in a command string entered before DONE have been started.

As shown by the example, if a take sweep (TS) precedes the DONE command, DONE is executed after all the preceding commands have been completed. Use a take sweep (TS) to ensure all previous commands have completed before DONE returns a “1.”

Query Response



QDONE

EDITANNOT

Edit Annotation

Enters the annotation editor.

Syntax

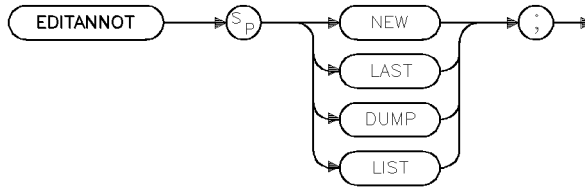

xeditan

Related Softkey: `EDIT ANNOTATN`

Related Commands: `EXITANNOT`

Example

```
OUTPUT 718; "EDITANNOT NEW;"
```

Description

The EDITANNOT command enters the annotation editor (NEW or LAST) or sends the contents of the annotation buffer to a printer (LIST) or to a controller (DUMP). The NEW parameter clears the annotation editor of all text.

EK Enable Knob

Allows data entry with the front-panel knob when the instrument is under remote control.

Syntax

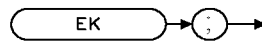

XEK

Example

<pre> 1 PRINTER IS 1 10 OUTPUT 718;"MKN;EK;" </pre>	<p><i>Activates a marker and enables the front-panel knob.</i></p>
<pre> 20 PRINT "USE KNOB TO PLACE MARKER" </pre>	<p><i>While the program pauses, the operator positions a marker on a signal that needs further analysis.</i></p>
<pre> 30 PRINT "PRESS CONTINUE WHEN DONE" 40 PAUSE </pre>	<p><i>Prompts user. The operator positions a marker on a signal that needs further analysis.</i></p>
<pre> : 100 END </pre>	<p><i>Insert analysis program here.</i></p>

Description

The EK command allows data entry with the front-panel knob when the instrument is under remote control.

With the EK command, the knob is functional, but other front-panel functions remain inoperative. Moving the knob changes the active function. If no function is active, moving the knob has no effect.

EP

Enter Parameter Function

Sends values entered on the instrument number keyboard to the present active function value.

Syntax

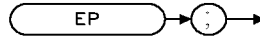

XEP

Related Commands: See the list of active functions listed in the description for EP

Example

OUTPUT 718;"ST;EP;" *The sweep time can be entered by using the front-panel keys.*

Description

The EP command allows the user to enter a value manually through the numeric keypad. When the value is terminated by a unit or **ENTER** key on the instrument, the instrument will be ready to execute more remote commands. EP must be invoked each time a new value is entered.

Note Because the EP command uses the current active function, confirm that the desired function is active before executing the EP command.

The active functions are: AT, AVBW, BAUDRATE, CF, DL, FA, FB, FMGAIN, FOFFSET, IFBW, LG, MKA, MKD, MKFCR, MKN, MKPAUSE, MKPX, ML, M4, NRL, PREAMPG, PRNTADRS, RB, RCLS, ROFFSET, RL, RLPOS, SAVES, SETDATE, SETTIME, SP, SQLCH, SRCAT, SRCPOFS, SRCPSTP, SRCPSWP, SRCPWR, SRCTK, SS, ST, TH, TIMEDATE, VB, VBR.

ERASE

Erase

Clears trace A and trace B.

Syntax

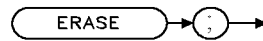

XERASE

Related Commands: DISPOSE, PSTATE

Example

```
OUTPUT 718;"ERASE;"
```

Description

The ERASE command erases *all* of the user memory by performing a DISPOSE ALL, moving zeros into the trace elements of trace B, and performing an instrument preset (IP). If PSTATE is set to OFF, ERASE clears the state registers also.

EXITANNOT

Exit Annotation

Exits from the annotation editor.

Syntax

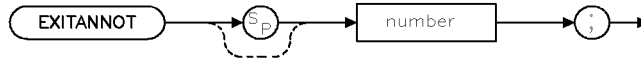

xexitant

Item	Description/Default	Range
Number	Any integer.	0 to 5461

Equivalent Softkey: `Exit Edit`

Related Commands: EDITANNOT, MENU

Example

```
OUTPUT 718; "EXITANNOT;"
```

Description

The EXITANNOT command exits from the annotation editor. The parameter specifies which menu to display on the screen and make active.

EXP Exponent

Places the exponential of the source in the destination.

Syntax

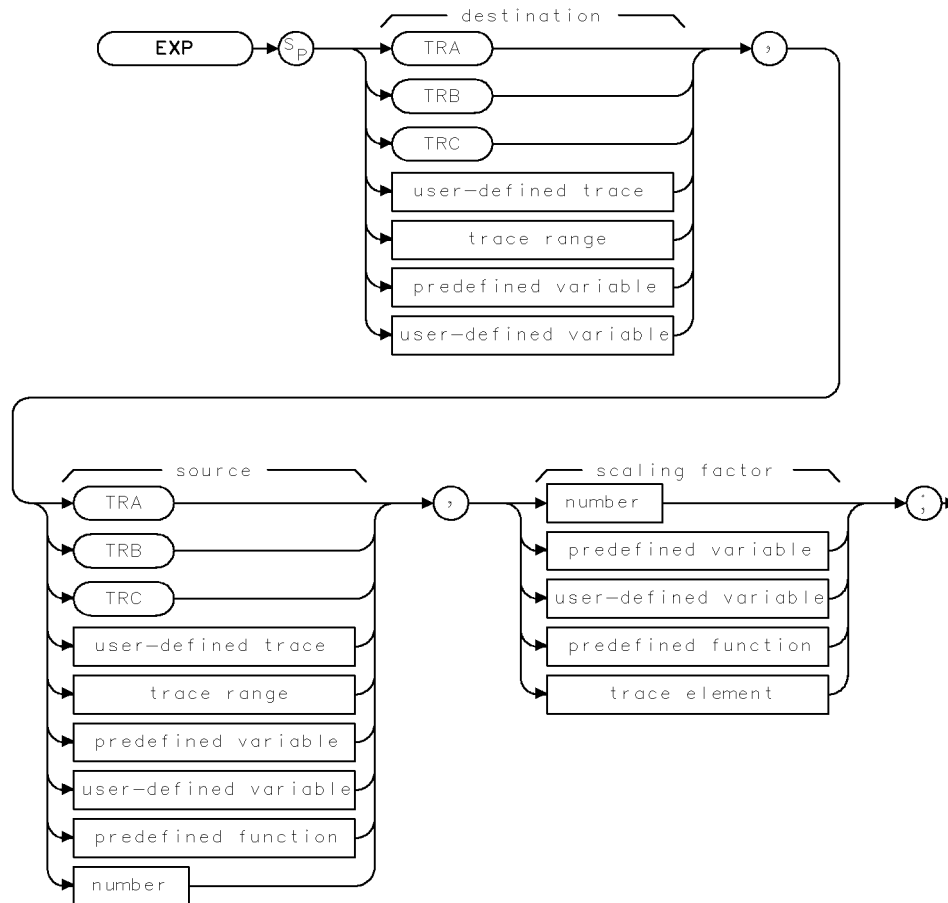

Item	Description/Default	Range
User-defined trace	A trace defined by the TRDEF command.	Any valid trace name.
User-defined variable	A variable defined by VARDEF command.	
Predefined variable	A command that acts as a variable. Refer to Table 4-1.	
Predefined function	Function that returns a value. Refer to Table 4-1.	
Trace range	A segment of trace A, trace B, trace C, or a user-defined trace.	
Trace element	An element of trace A, trace B, trace C, or a user-defined trace.	
Number	Any real or integer number.	Real number range.

Prerequisite Commands: TRDEF when using a user-defined trace. VARDEF when using a user-defined variable. TS when using trace data.

Related Commands: LOG

EXP Exponent

Example 1

This example converts the marker amplitude to power units.

10 OUTPUT 718;"IP;"	<i>Initializes the instrument.</i>
20 OUTPUT 718;"SNGLS;"	<i>Activates the single-sweep mode.</i>
30 OUTPUT 718;"VARDEF P_MW,0;"	<i>Initializes variable P_MW to 0.</i>
40 OUTPUT 718;"TS;MKPK HI;"	<i>Finds highest peak of sweep.</i>
50 OUTPUT 718;"EXP P_MW,MKA,10;"	<i>Divides the marker amplitude by 10, raises the value of the marker amplitude to the power of 10, and stores the results in P_MW.</i>
60 OUTPUT 718;"P_MW?;"	<i>Returns the value of P_MW to computer.</i>
70 ENTER 718;Number	<i>Assigns value to computer variable.</i>
80 DISP Number;"mW"	<i>Displays result on the computer screen.</i>
90 END	

Example 2

This example finds the natural exponential of a number and uses the LOG command to return the original source value of the EXP function.

10 OUTPUT 718;"VARDEF E_XP,0;"	<i>Defines a variable called E_XP.</i>
20 OUTPUT 718;"EXP E_XP,2,2.30259;"	<i>Finds the natural exponential of 2.</i>
30 OUTPUT 718;"E_XP?;"	<i>Returns the natural exponent of 2.</i>
40 ENTER 718;Value	
50 PRINT Value	<i>Prints the value of the exponential.</i>
60 OUTPUT 718;"LOG E_XP,E_XP,2.30259;"	<i>Uses the log function on the exponential value.</i>
70 OUTPUT 718;"E_XP?;"	<i>The log of the exponential value is approximately 2.</i>
80 ENTER 718;Logvalue	
90 PRINT Logvalue	<i>Prints value.</i>
100 OUTPUT 718;"VARDEF E_XPY,0;"	<i>Declares a variable called E_XPY.</i>
110 OUTPUT 718;"EXP E_XPY,-5,2.30259;"	<i>Finds the natural exponential of -5.</i>
120 OUTPUT 718;"E_XPY?;"	<i>Returns the value of the natural exponential of -5.</i>
130 ENTER 718;Value2	
140 PRINT Value2	<i>Prints the value of the exponential.</i>
150 OUTPUT 718;"LOG E_XPY,E_XPY,2.30259;"	<i>Uses the log function on the exponential value.</i>
160 OUTPUT 718;"E_XPY?;"	<i>The log of the exponential value is approximately -5.</i>
170 ENTER 718;Logval	
180 PRINT Logval	
190 END	

Description

The EXP command places the exponential of the source in the destination. It first divides the source by the scaling factor, then uses the quotient as an exponent of 10:

$10^{\text{source}/\text{scaling factor}}$ is placed into the destination.

The EXP command can be used to evaluate a natural exponential function by using 2.30259 as the scaling factor. Because EXP and LOG are inverse functions, the EXP command has a scaling factor that may be used to “undo” the scaling factor of the LOG command. (See example 2.)

When the source is longer than the destination, the source is truncated to fit. When the source is shorter than the destination, the last element is repeated to fill the destination.

The EXP command is useful for converting log values to linear values. See “LOG” for more information on the scaling factor.

FA

Start Frequency

Specifies the start frequency.

Syntax

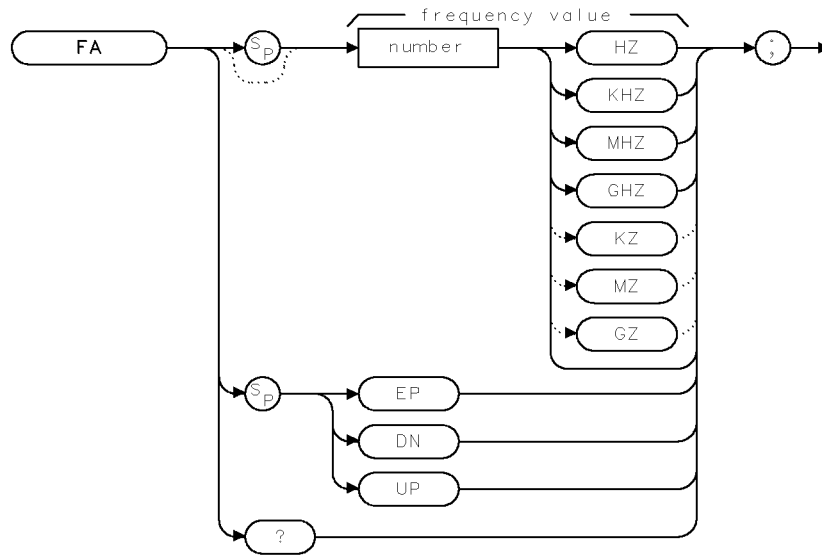

XFA

Item	Description/Default	Range
Number	Any real or integer number. Default unit is Hz.	Frequency range of the instrument.

Equivalent Softkey: **START FREQ**

Step Increment: Frequency span divided by 10

Related Commands: CF, FB, FOFFSET, FS, HNLOCK, HNUNLK, MKF, SP

Example

OUTPUT 718;"FA 88MHZ;FB 108MHZ;" *Sets the start frequency to 88 MHz, the stop frequency to 108 MHz.*

OUTPUT 718;"FA?;" *Returns the start frequency.*

ENTER 718;Freq *Stores the response from the instrument.*

DISP Freq *Displays the frequency on the computer screen.*

Description

The FA command specifies the start frequency value. The start frequency is equal to the center frequency minus the span divided by two ($FA = CF - SP/2$).

Note Changing the start frequency changes the center frequency and span. The start frequency may be limited by the harmonic band, if harmonic band locking is in effect, or may be limited by the input frequency range of the RF filter section.

Query Response

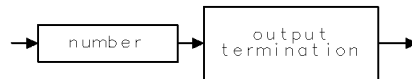

001

FASTMRKR

Fast Marker

Increases the range of the marker-positioning functionality of the knob and step keys.

Syntax

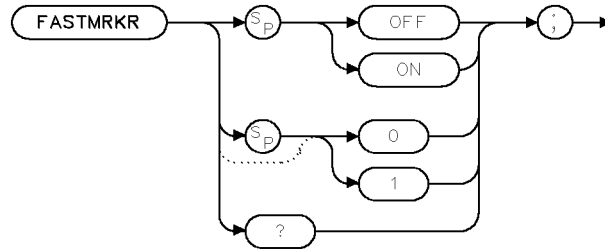

x f s t m r k .

Equivalent Softkey: **TUNE SLO FAST**

Prerequisite Command: RCVRMRKR

Preset Value: FASTMRKR OFF

Related Commands: MKN, MKD, MKACTION, MKACTIONV, MKFC, RCVRMRKR, UP, DN, CF

Example

```
10 OUTPUT 718; "FASTMRKR ON:"
```

Description

The FASTMRKR command increases the speed of the marker positioning and center frequency tuning functionality of the knob and step keys.

For marker positioning, there is no effect unless RCVRMRKR is also on. With FASTMRKR ON, the knob changes the marker position by four times the normal rate.

For center frequency, irregardless of the RCVRMRKR setting, with FASTMRKR ON, the knob tuning is eight times the normal rate.

Query Response

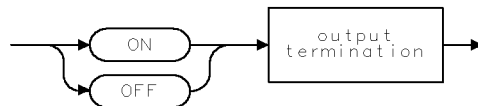

002

FB Stop Frequency

Specifies the stop frequency.

Syntax

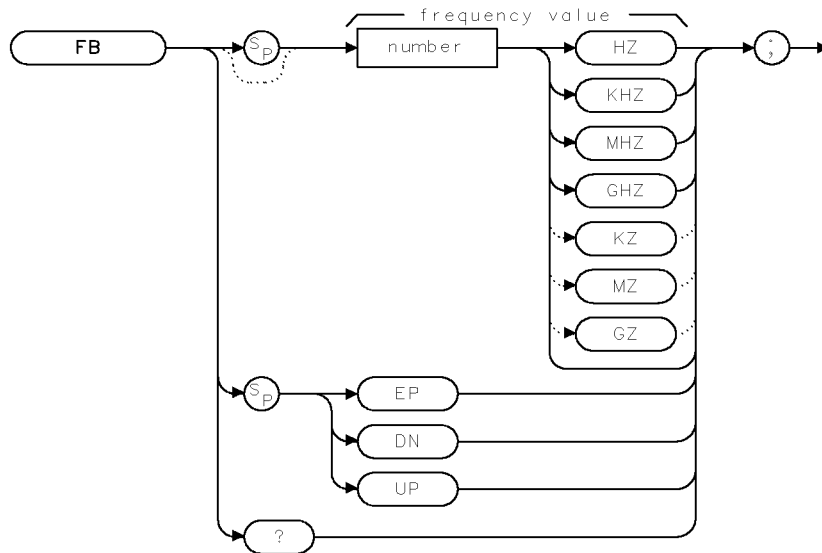

XFB

Item	Description/Default	Range
Number	Any real or integer number. Default unit is Hz.	Frequency range of the instrument.

Equivalent Softkey: **STOP FREQ**

Step Increment: Frequency span divided by 10

Related Commands: CF, FA, FOFFSET, FS, HNLOCK, MKF, SP

Example

OUTPUT 718;"FA 88MHZ;FB 108MHZ;" *Sets the start frequency to 88 MHz, the stop frequency to 108 MHz.*

OUTPUT 718;"FB?;" *Returns the stop frequency.*

ENTER 718;Freq *Stores the response from the instrument.*

DISP Freq *Displays the frequency on the computer screen.*

FB Stop Frequency

Description

The FB command specifies the stop frequency value. The stop frequency is equal to the center frequency plus the span divided by two ($FA = CF + SP/2$).

Note Changing the stop frequency changes the center frequency and span. The stop frequency may be limited by the harmonic band, if harmonic band locking is in effect, or may be limited by the input frequency range of the RF filter section.

Query Response

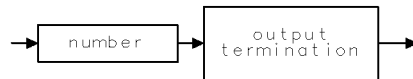

001

FCALDATE

Last Calibration Date

Returns the date of the last calibration that was performed.

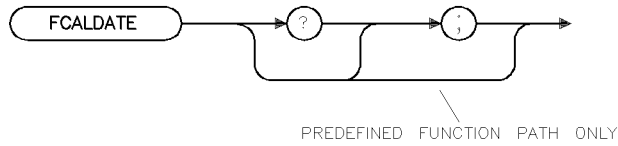

xfcaldt

Item	Description/Default	Range
Number	A number in YYMMDD format.	Valid year, month, and day.

Example

10 DIM Serial\$[24]	<i>Reserves memory space for a string.</i>
20 OUTPUT 718; "FCALDATE"	<i>Gets the cal date from the system.</i>
30 ENTER 718;Serial\$	<i>Puts the system response into the computer vairable.</i>
40 DISP Serial\$	<i>Displays the cal date on the computer screen.</i>

Description

The FCALDATE command returns the date of the last service calibration that was performed on the EMI receiver.

Query Response

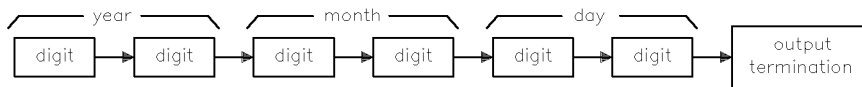

qfcaldt

FFT

Fast Fourier Transform

Performs a discrete fast Fourier transform on the source trace array.

Syntax

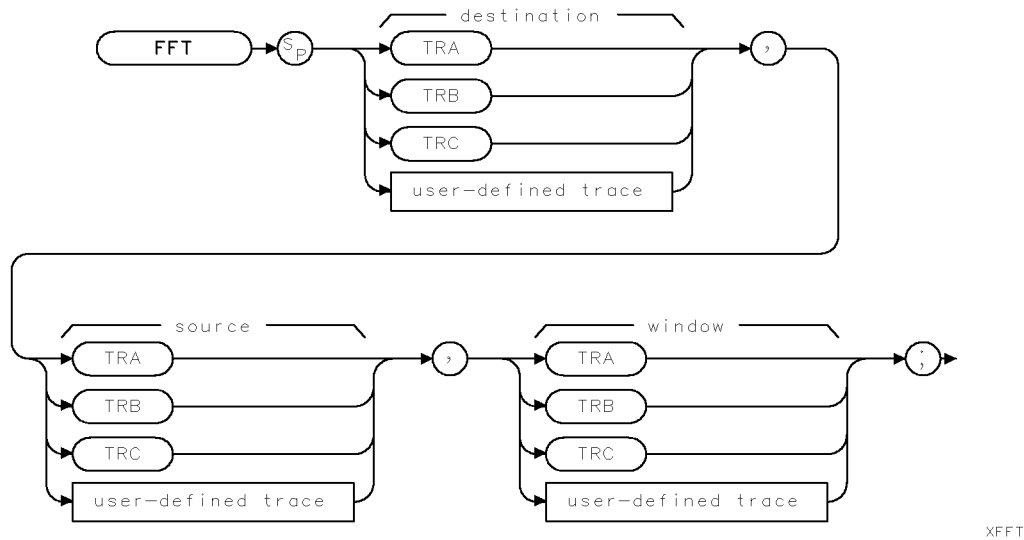

Item	Description/Default	Range
User-defined trace	A trace defined by the TRDEF command.	Any valid trace name.

Prerequisite Command: TWNDOW

Related Commands: MKREAD, TWNDOW

Example

OUTPUT 718;"IP;SNGLS;"	<i>Initializes instrument.</i>
OUTPUT 718;"CF 300MHZ;TS;MKPK HI;MKTRACK ON;"	<i>Tunes center frequency to the carrier and decreases span.</i>
OUTPUT 718;"CONTS;SP 200KHZ;IFBW 100KHZ;"	<i>Changes resolution bandwidth to capture modulation.</i>
OUTPUT 718;"MKTRACK OFF;SP 0HZ;"	<i>Reduces span to zero Hz to demodulate carrier.</i>
OUTPUT 718;"MKPK HI;MKRL;LN;SNGLS;"	<i>Changes to linear amplitude scale.</i>
OUTPUT 718;"ST 800MS;TS;"	<i>Sets sweep time to correspond to modulation frequency, the executes FFT function.</i>
OUTPUT 718;"TWNDOW TRB,FLATTOP;"	<i>The TWNDOW must be defined before using the FFT function.</i>
OUTPUT 718;"FFT TRA,TRA,TRB;VIEW TRA;"	<i>Executes the FFT function with the trace window function.</i>
OUTPUT 718;"MKPK HI;"	<i>Finds the highest signal.</i>

FFT Fast Fourier Transform

OUTPUT 718;"MKD;"	<i>Activates the marker delta function.</i>
OUTPUT 718;"MKPK NR;"	<i>Finds the next peak to the right.</i>
OUTPUT 718;"MKREAD FFT;"	<i>Selects the FFT marker to display the marker delta value as a frequency instead of time value.</i>
OUTPUT 718;"MKF?;"	<i>Finds the difference between the two peaks.</i>
ENTER 718;A	
DISP A	<i>Displays the frequency difference.</i>

Description

The FFT command performs a discrete fast Fourier transform on the source trace array and stores the result in the destination array.

FFT weights the source trace with the function in the window trace (the window trace is described below). The transform is computed and the results are placed in the destination trace.

The instrument should be in linear mode when using the FFT command. The FFT results are displayed on the instrument in logarithmic scale. For the horizontal dimension, the frequency at the left side of the graph is 0 Hz, and at the right side is Fmax.

Note An illegal command SRQ error will be returned if this command is used when the SWEEPTYPE is set to "LOG".

Fmax can be calculated using a few simple equations and the sweep time of the instrument. The sweep time divided by the number of trace array elements containing amplitude information is equal to the sampling period. The reciprocal of the sampling period is the sampling rate. The sampling rate divided by two yields Fmax.

For example, let the sweep time of the instrument be 20 ms and the number of trace elements be 400. The sweep time (20 ms) divided by 400 equals 50 μ s, the sampling period. The sample rate is 1/50 μ s. Fmax equals 1/50 μ s divided by 2, or 10 kHz.

FFT is designed to be used in transforming zero span information into the frequency domain. Performing FFT on a frequency sweep (when the frequency span is greater than zero) will not provide time-domain results.

The windowing function stored in the window trace may be selected with the trace window (TWINDOW) command or you can store your own values in that trace. The trace window function modifies the contents of a trace array according to one of three built-in algorithms: UNIFORM, HANNING, or FLATTOP. See Figure 4-2, Figure 4-3, and Figure 4-4. The TWINDOW command multiplies a trace array with one of these windows.

Selecting a window: The amplitude and frequency uncertainty of the Fourier-transformed display depends on both the choice of trace windows and the instrument sweep time. Amplitude uncertainty is maximum when the spectral component falls midway between the filter shapes. Passbands that are flatter in shape, like the FLATTOP filter, contribute less amplitude uncertainty, but frequency resolution and sensitivity are compromised.

The UNIFORM window algorithm has the least frequency uncertainty and greatest amplitude uncertainty. The UNIFORM window does not contain time-domain weighing and leaves the data alone. Use the UNIFORM window for transforming noise signals or transients that decay within one sweep time period. The UNIFORM window yields the best frequency resolution, but also produces the highest side lobes for periodic signals.

FFT Fast Fourier Transform

The FLATTOP window has the greatest frequency uncertainty of the windows, but it has outstanding side lobe suppression and amplitude flatness. Use FLATTOP to transform periodic signals.

The HANNING window is a traditional passband window found in most real-time instruments. The HANNING window offers a compromise between the FLATTOP and UNIFORM windows. Use the HANNING window when transforming periodic or random data.

The values in the window trace range from $-32,768$ to $32,767$ and are treated as fractional numbers. No offset is used. When FFT is called, the average window value is computed and used to correct the results in absolute units.

The Fourier transforms of the window functions (created with TWINDOW) are shown below. Use the graphs to estimate resolution and amplitude uncertainty of a Fourier transform display. Each horizontal division of the graphs equals $1/\text{sweep-time}$ or $F_{\text{max}}/200$, and represents two trace array elements.

When the source is longer than the destination, the source is truncated to fit. When the source is shorter than the destination, the last element is repeated to fill the destination.

Note TWINDOW should always be set before FFT is executed. Execute MKREAD FFT to read the marker value as a frequency value instead of time value.

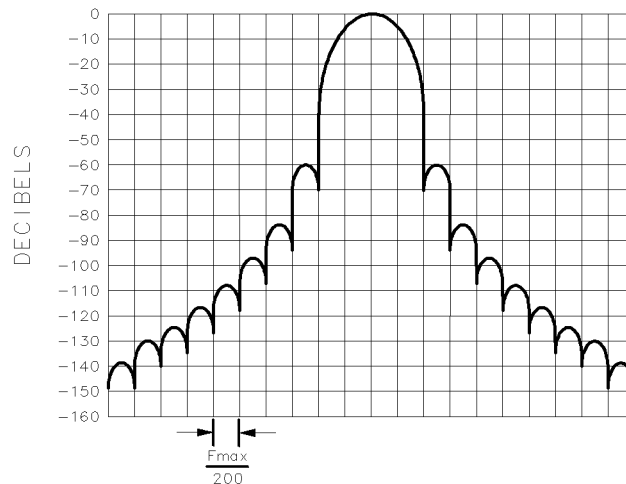

cu115e

Figure 4-2. Hanning Filter Window

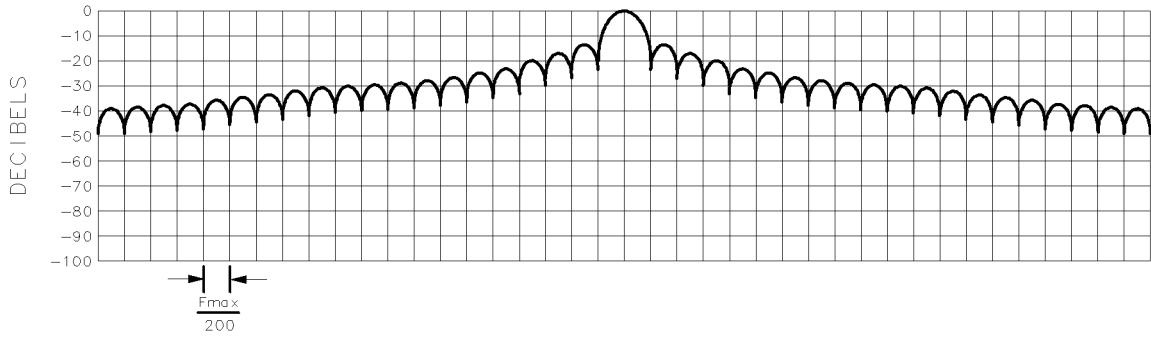

cu116e

Figure 4-3. Uniform Filter Window

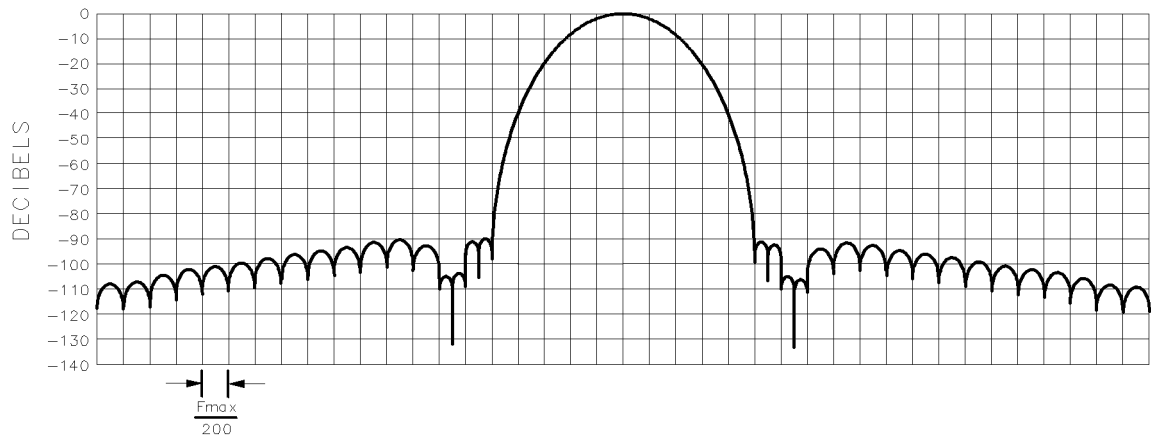

cu117e

Figure 4-4. Flat Top Filter Window

FMGAIN

FM Gain

Sets the total FM frequency deviation for full screen demodulation.

Syntax

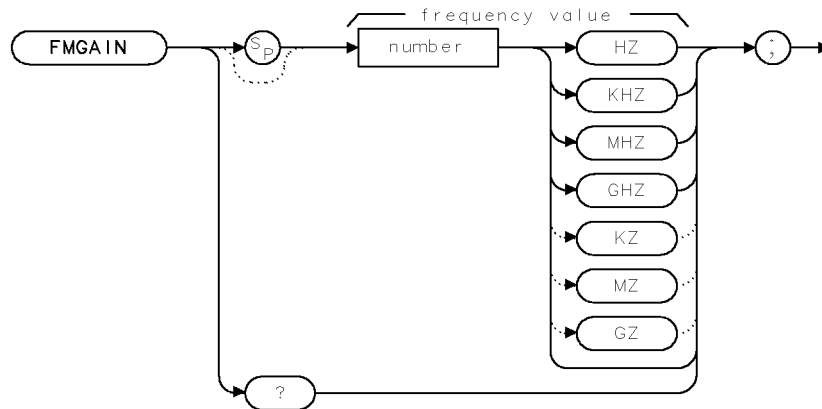

XFMGAIN

Item	Description/Default	Range
Number	Any real or integer number. Default unit is Hz.	10 kHz to 500 kHz.

Equivalent Softkey: **FM GAIN**
 Preset Value: 100 kHz
 Related Commands: DEMOD, SPEAKER, SQLCH

Example

OUTPUT 718;"FMGAIN 10KHZ;" *Sets the FM gain.*

Description

The FMGAIN command sets the total FM frequency deviation for full screen demodulation. The center of the display (the fourth graticule) represents zero frequency deviation from the instrument center frequency. The top graticule and the bottom graticule represent a positive or negative value of FM gain frequency deviation from the instrument center frequency. The value of FMGAIN divided by four yields the FM gain per division.

Query Response

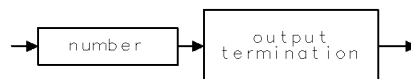

001

FOFFSET

Frequency Offset

Specifies the frequency offset for all absolute frequency readouts such as center frequency.

Syntax

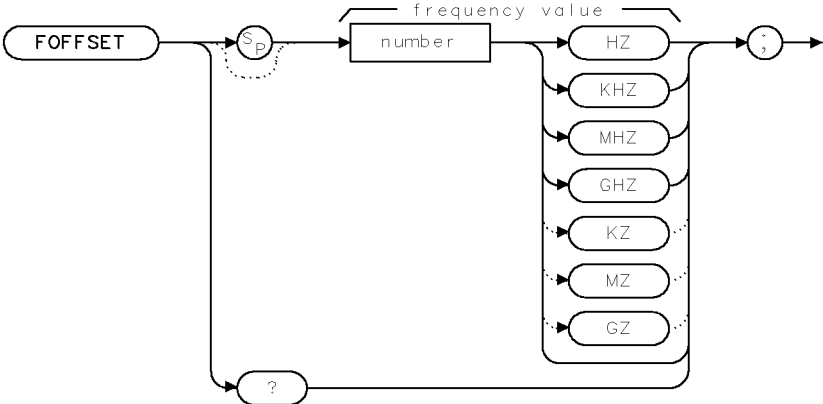

XFOFFSET

Item	Description/Default	Range
Number	Any real or integer number. Default unit is Hz.	

- Equivalent Softkey: **FREQ OFFSET**
- Preset State: 0 Hz
- Related Commands: CF, FA, FB, MKN, MKF, MKSP, MKSS

Example

```

10 OUTPUT 718;"IP;FA 200MZ;"      Initializes instrument. Sets start frequency.
20 OUTPUT 718;"FB 1GZ;"          Sets stop frequency.
30 OUTPUT 718;"TS;MKPK HI;"      Places marker on signal peak.
40 OUTPUT 718;"MF;"              Finds frequency of marker.
50 ENTER 718;A
60 PRINT A                        Prints frequency of marker.
70 OUTPUT 718;"FOFFSET 500MZ;"    Adds a frequency offset.
80 OUTPUT 718;"TS;MF;"           The frequency of the marker now is the frequency of
                                  the signal peak plus the frequency offset.

90 ENTER 718;A
100 PRINT A                       The displayed frequency is 500 MHz greater than the
                                  frequency displayed in line 60.

110 END

```

FOFFSET Frequency Offset

Description

The FOFFSET command selects a value that offsets the frequency scale for all absolute frequency readouts (for example, center frequency). Relative values such as span and marker delta are not offset.

After execution, the FOFFSET command displays the frequency offset in the active function readout. When an offset is in effect, it is displayed beneath the bottom graticule line on the screen.

Execute “FOFFSET 0;” or “IP;” to turn off the offset.

Query Response

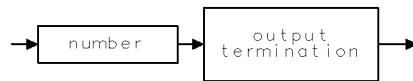

001

FORMAT Format Disk

Formats the floppy disk.

Syntax

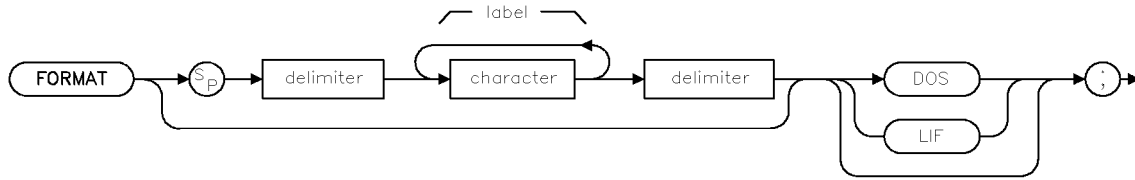

xformatd

Item	Description/Default	Range
Character	Any valid character.	0 to 6 characters long, A through Z and the underscore (the underscore cannot be the first character of the label).
Delimiter	Matching characters marking the beginning and end of the list of instrument commands.	~ \ @ = / ^ \$ % ; ! ' : " &

Equivalent Softkey: `FORMAT DOS DISK` or `FORMAT LIF DISK`

Example

OUTPUT 718;"FORMAT 'MYDISK' DOS;" *Formats a floppy disk, DOS format, with the label "MYDISK."*

Description

The FORMAT command formats the floppy disk. If the DOS/LIF specifier is not present, the disk will be formatted to its current format (DOS or LIF) . If the disk is not currently DOS or LIF formatted, and neither DOS or LIF is specified, the disk will be formatted as a DOS disk.

The volume label is limited to eleven characters. If a label is not specified, the label defaults to HP 8546A (the label defaults to HP 8542E for an HP 8542E).

FS

Full Span

Sets the frequency span of the instrument to full span.

Syntax

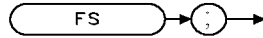

XFS

Equivalent Softkey: **FULL SPAN**

Related Commands: CF, FA, FB, HNLOCK, RFINLK, SP, SS

Example

OUTPUT 718;"FS;" *Puts the instrument in full-span mode.*

Description

The FS command sets the start frequency to 0 Hz and the stop frequency to 6.5 GHz (2.9 GHz for an HP 8542E/HP 85422E). Resolution bandwidth, video bandwidth, and sweep time are all set to autocoupled.

In harmonic lock, "FS;" sets both the center frequency and the span to: according to the harmonic band shown in the following table.

Center Frequency and Span Settings

Harmonic Band	Center Frequency	Span
0	1.45 GHz	2.9 GHz
1 ¹	4.638 GHz	3.6 GHz

¹ For an HP 8546A/HP 85462A only.

Note If the HP 85420E/HP 85460A RF filter section is present, the span resulting may be limited by the currently applicable input paths frequency range.

FSER RF Filter Section Serial Number

Returns the serial number of the RF filter section.

Syntax

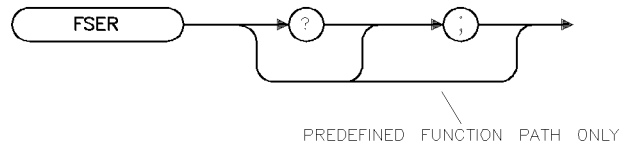

xfser

Related Commands: ID, REV, SER

Example

```

10 DIM Serial$[24]      !Reserves memory space for astring.
20 OUTPUT 718; "FSER;" !Gets the serial number from the instrument.
30 ENTER 718;Serial$    !Puts the instrument response in the computer variable.
40 DISP Serial$         !Displays the serial number on the computer screen.
    
```

Description

The FSER command returns the serial number suffix of the RF filter section.

Query Response

The last five digits of the serial number are returned.

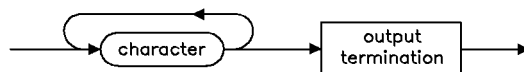

qq4

GRAT Graticule

Turns on or off the graticule.

Syntax

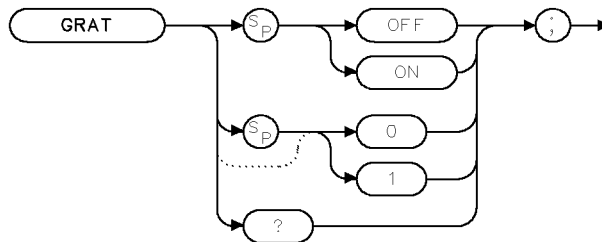

XGRAT

Equivalent Softkey: **GRAT ON OFF**

Preset State: GRAT ON

Related Commands: ANNOT

Example

```
OUTPUT 718;"GRAT OFF;"  Turns off the graticule.
OUTPUT 718;"GRAT?;"    Queries graticule status.
ENTER 718;Grat$        Gets response from the instrument.
DISP Grat$              Displays OFF on the computer screen.
```

Description

The GRAT command turns on or off the graticule.

Query Response

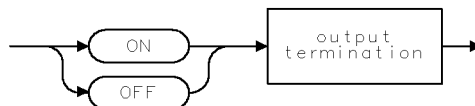

002

HAVE Have

Returns status of the device.

Syntax

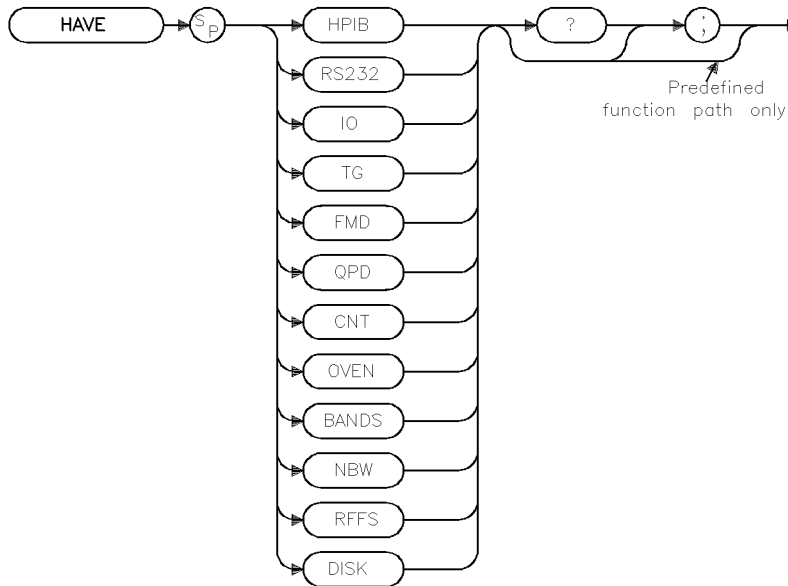

xhave

Equivalent Softkey: **SHW INST CONFIG**

Example

```
OUTPUT 718;"HAVE RFFS;" Queries whether the RF filter section is installed.
ENTER 718;A Receives response from instrument.
DISP A Displays response.
```

Description

The HAVE command returns the status of devices installed. In most cases, a “1” indicates that the device is installed; a “0” if the device is not installed. For specific device conditions, refer to the listing below.

- HPIB HP-IB interface
- RS232 RS-232 interface, Option 023
- IO Either the HP-IB interface or RS-232 interface (Option 023)
- TG Tracking generator
- FMD FM demodulator
- QPD Quasi-peak detector

HAVE Have

CNT	Counter-lock returns a 1 if installed but not enabled, or a 3 if installed and enabled
OVEN	Precision frequency reference
BANDS	Returns a value (1 or 2) for the number of frequency bands.
NBW	Narrow bandwidths
RFFS	RF filter section
DISK	Returns additional information about the disk drive.

“HAVE DISK;” returns additional information about the disk drive. By checking the bit status of the byte returned from “HAVE DISK;” you can determine the following:

Bit Position	Bit Status = 0	Bit Status = 1
0	Disk controller/drive not installed.	Disk controller/drive is installed.
1	Disk is write protected.	Disk is not write protected.
2	Always 0	N/A
3	Disk not inserted into disk drive.	Disk is inserted into disk drive.
4	Inserted disk is not LIF format.	Inserted disk is LIF format.
5	Inserted disk is not DOS format.	Inserted disk is DOS format.
6	Always 0	N/A
7	Always 0	N/A

You can use the BIT or BITF command to determine the status of the bits. For example,

OUTPUT 718;"VARDEF R_RESULT,0;"	<i>Stores the bit status in R_RESULT.</i>
OUTPUT 718;"BIT R_RESULT,HAVE DISK,3;"	<i>Checks the status of bit 3.</i>
OUTPUT 718;"R_RESULT?;"	<i>Gets the result.</i>
ENTER 718;A	
DISP A	<i>Displays the bit status of bit 3.</i>

Query Response

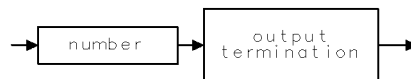

001

HD Hold Data Entry

Disables data entry via the instrument numeric keypad, knob, or step keys.

Syntax

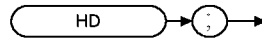

XHD

Equivalent Softkey:

HOLD

Related Commands:

Any active function. See the description below for a list of the active functions.

Example

```
OUTPUT 718;"HD;"
```

Disables the active function and clears the active function block area on the screen.

```
OUTPUT 718;"CF 600MHZ;HD;700MHZ;"
```

This will leave the center frequency at 600 MHz, because HD deactivates any current function.

Description

The HD command disables data entry via the instrument numeric keypad, knob, or step keys. The active function readout is blanked, and any active function is deactivated. The active functions are: AT, AVBW, BAUDRATE, CF, COUPLE, DL, FA, FB, FMGAIN, FOFFSET, GL, GP, IFBW, INZ, LG, MKA, MKD, MKFC, MKFCR, MKN, MKPAUSE, MKPX, ML, NRL, PREAMPG, RB, RCLS, ROFFSET, RL, RLPOS, SAVES, SETDATE, SETTIME, SP, SQLCH, SRCAT, SRCPOFS, SRCPSTP, SRCPSWP, SRCPWR, SRCTK, SS, ST, TH, TIMEDATE, VAVG, VB, VBR, ZMKSPAN, and ZMKCNTR.

HN Harmonic Number

Returns the harmonic number of the current harmonic band.

Syntax

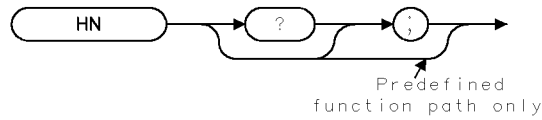

XHN

Related Commands: FS, HNLOCK, HNUNLK

Example

```
OUTPUT 718;"HN?;" Queries harmonic band of instrument.
ENTER 718;Number Gets response from the instrument.
DISP Number Displays the result on computer screen.
```

Query Response

The HN command returns the harmonic number of the current harmonic band in which the instrument is tuning. A “-1” is returned if the instrument is sweeping multiband.

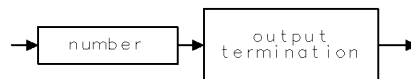

001

HNLOCK

Harmonic Number Lock

For an HP 8546A/HP 85462A only.

Forces the instrument to use only the selected harmonic band.

Syntax

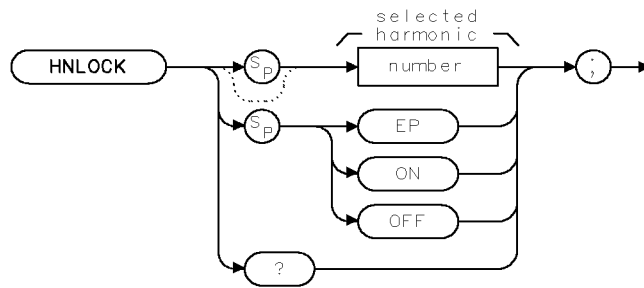

Item	Description/Default	Range
Number	Any integer	0 to 1

Equivalent Softkey: the softkeys accessed by **Band Lock**

Preset State: HNLOCK OFF

Related Commands: CF, FA, FB, FOFFSET, HN, HNUNLK, SNGLS, SP

Example

INPUT "SELECT THE DESIRED FREQUENCY BAND",Harm *Gets harmonic band from user.*
 OUTPUT 718;"HNLOCK ";Harm;" *Locks harmonic band.*

Description

The HNLOCK command forces the instrument to use only the selected harmonic band. HNLOCK ON locks onto the harmonic band that is appropriate for the current center frequency, lowering the span, if necessary, due to the limits of the harmonic band.

HNLOCK <number>, where <number> is an integer, locks onto harmonic band <number> and automatically selects the settings shown in the following table.

Remote Commands	Equivalent Softkey	Frequency Settings	
HNLOCK 0	BAND 0	Center frequency 1.450 GHz	Span 2.900 GHz
HNLOCK 1	BAND 1	Center frequency 4.638 GHz	Span 3.600 GHz

Once HNLOCK is set, only frequencies and spans that fall within the frequency band of the current harmonic may be entered. The span is reduced automatically to accommodate a center frequency specified near the end of the band range.

HNLOCK Harmonic Number Lock

Note Before changing the frequency range to another harmonic, unlock the band with the harmonic unlock command, “HNLOCK OFF;” or “HNUNLK;”.

BAND LOCK ON (HNLOCK ON)

Start Frequency

If a start frequency is entered that is outside of the current band boundaries, it will be set to the nearest band edge instead. If a start frequency that is greater than the current stop frequency is entered, the (possibly modified) start frequency is used for both the start and the stop frequency; therefore, the span will be set to zero. If the start and stop frequencies specify too large a span, they will be modified. (Also see “FA.”)

Stop Frequency

If a stop frequency is entered that is outside of the current band boundaries, it will be set to the nearest band edge instead. If a stop frequency that is less than the current start frequency is entered, the (possibly modified) stop frequency will be used for both the start and stop frequency; therefore, the span will be set to zero. (Also see “FB.”)

Center Frequency

The span will be modified if necessary to get the center frequency specified without crossing the band edges. (Also see “CF.”)

Span

The span will be limited as necessary to keep the start and stop frequencies within the band edges without changing the center frequency. The maximum span allowed is 2.943 GHz in band 0, 3.600 GHz in band 1. (Also see “SP.”)

BAND LOCK OFF (HNLOCK OFF)

The start and stop frequencies are bounded by the range of the instrument, and limits the RF filter section inputs.

Query Response

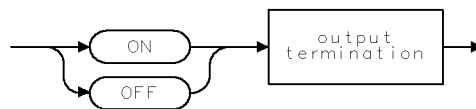

002

HNUNLK Unlock Harmonic Number

For an HP 8546A/HP 85462A only.

Unlocks the harmonic band.

Syntax

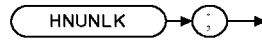

XHNUNLK .

Equivalent Softkey: **BND LOCK ON OFF**
 Preset State: HNUNLK OFF
 Related Commands: CF, FA, FB, FOFFSET, FS, HN, HNLOCK, SP

Example

```
OUTPUT 718;"HNUNLK;"
```

Description

The HNUNLK command allows you to select frequencies and spans outside the range of a single harmonic band.

IB Input B

Provides a method for putting values into trace B.

Syntax

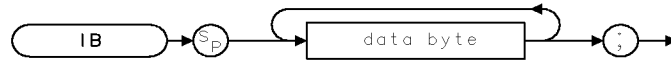

X1B

Item	Description/Default	Range
Data byte	8-bit byte containing numeric or character data.	

Example

```

10 ASSIGN @Sa TO 718;FORMAT ON
20 ASSIGN @Sa_bin TO 718;FORMAT OFF
30 INTEGER Binary(1:401)
40 OUTPUT @Sa;"CF 300MZ;CLRW TRB;BLANK TRA;SP
10MZ;SNGLS;TS;"
50 OUTPUT @Sa;"TDF B;MDS W;TB;"
60 ENTER @Sa_bin;Binary(*)
70 OUTPUT @Sa;"CF 100MZ;IFBW 30KZ;SP 1MZ;TS;"
80 DISP "PRESS CONTINUE WHEN READY"
90 PAUSE
100 OUTPUT @Sa;"IB";
110 OUTPUT @Sa_bin;Binary(*)
120 OUTPUT 718;"VIEW TRB;"
130 END

```

Dimensions an array called "Binary."

Takes a measurement sweep.

Outputs trace B (in binary) to computer.

Stores trace data in array.

Changes the instrument settings.

Prepares instrument to receive trace B data stored in array.

Sends trace B data to instrument.

Description

The IB command sends trace B data as binary data only; IB is independent of the measurement data size (MDS) command. The IB command expects 802 data bytes (401 data points, two bytes each). The data values can represent the range of the integer numbers.

ID Identify

Returns the instrument model number.

Syntax

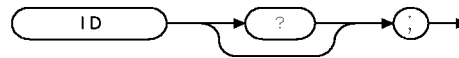

XID

Equivalent Softkey: `SHW INST CONFIG`

Related Commands: `REV, SER`

Example

```

10 ALLOCATE A$ [50]   Allocates string to hold model number;
20 OUTPUT 718;"ID;"  Gets model number;
30 ENTER 718;A$      Transfers number to computer;
40 DISP A$           Displays model number.
50 END

```

Description

The ID command returns the instrument model number to the controller; for example, HP 8546A or HP 8542E is returned for an EMI receiver, HP 85462A or HP 85422E for a receiver RF section.

Query Response

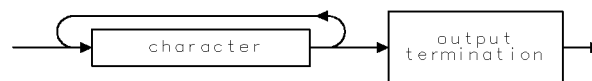

QID

IFBW

Intermediate Frequency Bandwidth

Specifies the intermediate frequency bandwidth.

Syntax

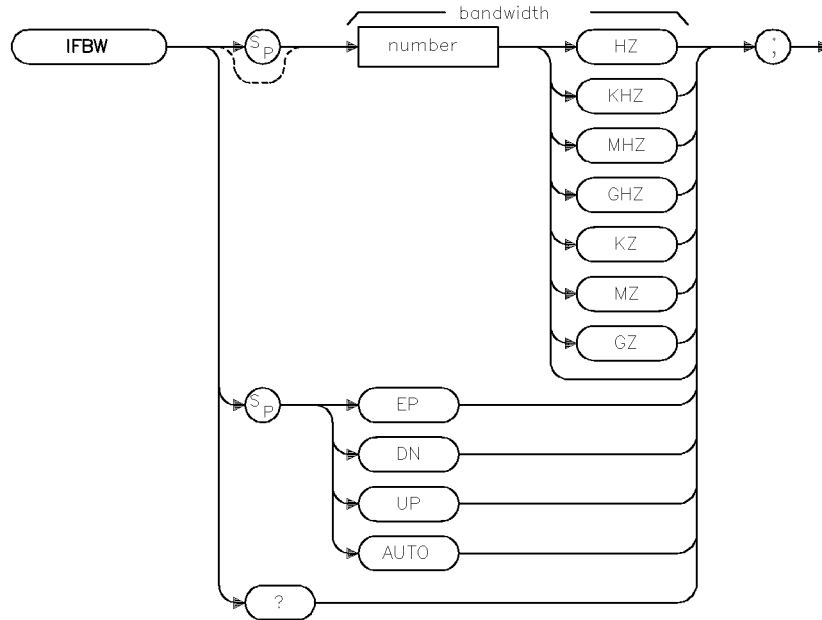

xifbw

Item	Description/Default	Range
Number	Any real or integer number. Default unit is Hz.	30 Hz to 3 MHz

Equivalent Softkeys: IF BW AUTO MAN

Preset State: 120 kHz

Step Increment: 1, 3, 10

Related Commands: AUTO, AVBW, SP, ST, VB, VBR, RB

Example

OUTPUT 718;"IFBW 1KHZ;" *Sets the intermediate frequency bandwidth to 1 kHz.*

IFBW Intermediate Frequency Bandwidth

Description

The IFBW command disables the coupling between sweep time and intermediate frequency bandwidth. Execute IFBW AUTO to reestablish coupling. (Also see “AUTO.”)

The 200 Hz, 9 kHz, and 120 kHz 6-dB intermediate frequency bandwidths (used for EMI testing) are available by specifying 200 Hz, 9 kHz, or 120 kHz as the frequency value; the front-panel knob, step increment keys, and auto-coupled settings provide the 1, 3, 10 intermediate frequency bandwidth sequence only. Frequencies are rounded to the nearest value in the 1, 3, 10 sequence if the frequency is other than 200 Hz 9 kHz, 120 kHz, 5 MHz, or in the 1, 3, 10 sequence.

The instrument provides uncalibrated bandwidths of 10 Hz and 5 MHz.

Query Response

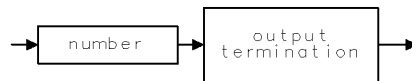

001

INT

Integer

Places the greatest integer that is less than or equal to the source value into the destination.

Syntax

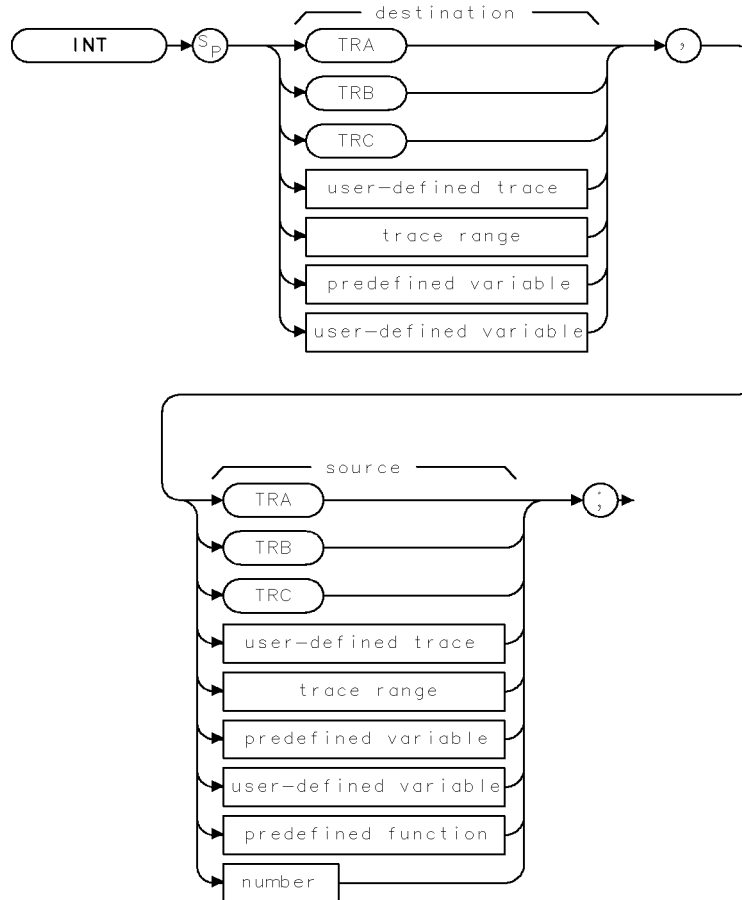

XINT

Item	Description/Default	Range
User-defined trace	A trace defined by the TRDEF command.	Any valid trace name.
User-defined variable	A variable defined by VARDEF command.	Any valid variable name.
Predefined variable	A command that acts as a variable. Refer to Table 4-1.	
Predefined function	Function that returns a value. Refer to Table 4-1.	
Trace range	A segment of trace A, trace B, trace C, or a user-defined trace.	
Number	Any real or integer number.	Real number range.

Prerequisite Command: TRDEF when using a user-defined trace. VARDEF when using a user-defined variable. TS when using trace data.

Related Commands: REPEAT/UNTIL

Example

OUTPUT 718;"INT RL,93.75;" *Resets the reference level using the integer value of 93.*

Description

The INT command places the greatest integer that is less than or equal to the source value into the destination. When the number of items in the source is longer than the destination, the source is truncated to fit. When the source is shorter than the destination, the last element is repeated to fill the destination.

When the instrument is sweeping across more than one band, taking the integer value of the sweep time (ST) may yield a real number.

INZ Input Impedance

For the HP 85422E/HP 85462A only.

Specifies the value of input impedance expected at the active input port.

Syntax

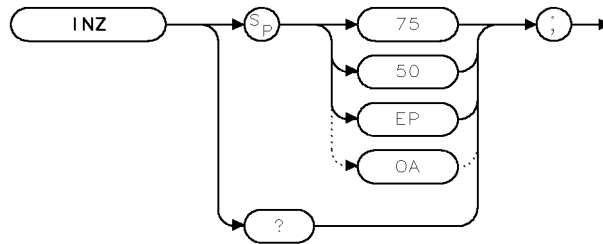

XINZ

Equivalent Softkey: **INPUT Z 50Ω 75Ω**

Preset Value: Returns impedance to the power-on value.

Related Commands: AUNITS

Example

OUTPUT 718;"INZ 75;" *Changes input impedance to 75 ohms.*

OUTPUT 718;"AUNITS V;" *Changes amplitude units to volts.*

Description

The INZ command specifies the value of input impedance expected at the active input port. The actual impedance can be affected only by internal hardware. The instrument hardware supports 50Ω only. The INZ command is used for computation purposes during power or voltage conversions.

The INZ command affects only the amplitude results that are reported in absolute relative power (dBm units or watts). (See "AUNITS.")

Query Response

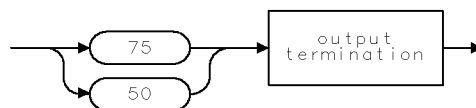

QINZ

IP Instrument Preset

Performs an instrument preset.

Syntax

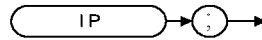

XIP

Equivalent Key:

PRESET

Example

```
OUTPUT 718;"IP;"
```

Description

The instrument preset command, IP, executes the following commands:

AMB:	Turns off A – B mode.
AMBPL:	Turns off A – B plus display line mode.
AMPCOR:	Turns off amplitude correction factors.
ANNOT:	Turns on annotation.
AT:	Sets attenuation to 10 dB.
AUNITS:	Loads the amplitude units from a configuration location in internal memory.
AUTO:	Couples AVBW, IFBW, RB, AT, SS, ST, and VB. Turns off display line and threshold.
AUTOAVG:	Turns on automatic measuring of the average detector.
AUTOQPD:	Turns on automatic measuring of the quasi-peak detector.
AVBW:	Sets the video bandwidth to 300 kHz.
BLANK B,BLANK C:	Blanks trace B and trace C.
CLRW A:	Clears and writes trace A.
CONTS:	Selects continuous sweep mode.
COUPLE:	Selects ac coupling.
DET:	Selects positive peak detection.
DL:	Turns off the display line.
FMGAIN:	Sets FM gain to 100 kHz.
FOFFSET:	Sets the frequency offset to 0 Hz.
GRAT:	Turns on the graticule.
HD:	Hold (deactivates active function).

IP Instrument Preset

HNLOCK OFF:	Unlocks harmonic band, allowing multiband sweeping.
IFBW:	Sets the resolution bandwidth to 125 kHz.
INZ:	Loaded from a configurable location in instrument memory.
LG:	Selects 10 dB per division log scale.
LIMIDISP:	Sets LIMIDISP to AUTO.
LIMIHI or LIMILO:	Clears any limit-line trace specified by LIMIHI or LIMILO.
LIMITEST:	Turns off limit-line testing.
MDS:	Selects data size of one word, which is two 8-bit bytes.
MEASURE:	Sets measurement to signal analysis.
MEASTIMEAVG:	Sets the average detector measurement time.
MEASTIMEQPD:	Sets the quasi-peak detector measurement time.
MEASTIMEPK:	Sets the peak detector measurement time.
MEASWITHPP:	Turns on the preselector.
MKFCR:	Marker counter resolution is set to AUTO, but a calculated value other than 0 may be returned if the marker counter resolution is queried.
MKNOISE:	Turns off noise markers.
MKOFF:	Turns off all markers.
MKPAUSE:	Turns off marker pause mode.
MKPX:	Minimum excursion for peak identification is set to 6 dB.
MKREAD:	Sets marker readouts to frequency.
MKTRACK:	Turns off marker tracking.
MKTYPE:	Sets the marker type as position type.
ML:	Sets mixer level to -10 dBm.
MSI:	Selects the disk drive as the mass storage device.
QPOFFSET:	Sets the QPOFFSET to 20.
RL:	Sets reference level to 92 dB μ V.
RLPOS:	Sets the reference level position to 8.
ROFFSET:	Sets reference offset to 0.
RQS 41:	Allows SRQ 110, SRQ 140 for illegal commands, broken hardware, or overload detection.
SPEAKER:	Turns on the speaker.
SQLCH:	Sets the squelch level to 0.
SRCALC:	Sets the source leveling control to internal.
SRCPSWP:	Sets the source power sweep to off.
SRCPWR:	Sets the source power level to 97 dB μ V.
SS:	Sets the center frequency step size to 100 MHz.
STATUS BYTE:	Clear the status byte.

IP Instrument Preset

TDF:	Selects parameter units output format.
TH:	One division above bottom graticule line, threshold line off.
TITLE:	Clears the title from the screen.
TM:	Selects free run trigger mode.
TRC:	Sets the trace values to 8000.
VAVG:	Turns off video averaging and sets the video averaging limit to 100.
VBR:	Sets VBR to 0.300.

IP also clears all user graphics, and turns off the windows display mode.

Instrument preset automatically occurs when you turn on the instrument. IP is a good starting point for many measurement processes. When IP is executed remotely, the instrument does not necessarily execute a complete sweep, however. You should execute a take sweep (TS) to ensure that the trace data is valid after an IP.

LASTKEYMENU

Last Key Menu

Changes the menu to the last hardkey menu that was active.

Syntax



x lastkm .

Equivalent Softkey:

LAST HRD KEY MENU

Example

```
OUTPUT 718; "LASTKEYMENU:"
```

Description

The LASTKEYMENU command changes the menu to the last hardkey menu that was active. This command provides quick access between two separate hardkey menus.

LF Base Band Instrument Preset

Performs an instrument preset.

Syntax

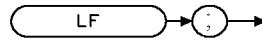

XLF

Related Commands: IP

Example

```
OUTPUT 718;"LF;"
```

Description

EMI Receiver Mode

The LF command is the same as the IP command. Refer to the IP command for a complete description of its functions.

Signal Analysis Mode

The LF command performs an instrument preset (IP) into base band (band 0). Use LF instead of IP if harmonic band 0 is desired.

LG

Logarithmic Scale

Specifies the vertical graticule divisions as logarithmic units, without changing the reference level.

Syntax

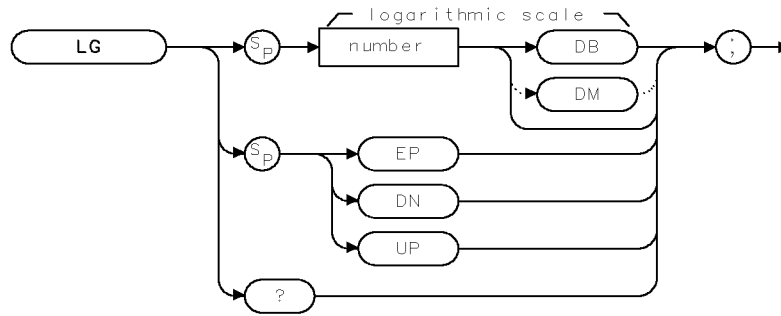

XLG

Item	Description/Default	Range
Number	Any real or integer number. Default units are dB.	0.1 to 20 dB.

Equivalent Softkey: **SCALE LOG LIN**

Preset State: 10 dB

Related Commands: LN

Example

```
OUTPUT 718;"LG 1DB;"
```

Description

The LG command specifies the vertical graticule divisions as logarithmic units, without changing the reference level. The vertical scale can be specified (in tenths) from 0.1 to 0.9 dB, or in integers from 1 to 20 dB per graticule division.

If LG is used as the destination in a MOV command, it changes the log scale, but does not change the scale from linear to logarithmic.

Query Response

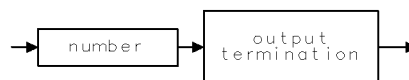

QQ1

LIMIAMPSC

Limit-Line Amplitude Scale

Specifies the limit-line amplitude scale definition as logarithmic or linear.

Syntax

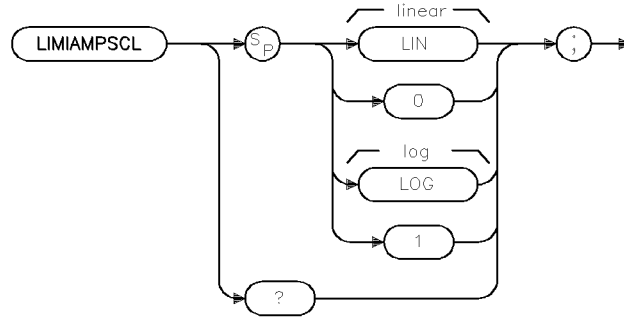

xlimiamp

Equivalent Softkey: **AMPL SCL LOG LIN**

Prerequisite Command: **LIMINUM**

Related Commands: **LIMIDEL, LIMIDISP, LIMIFAIL, LIMIFRQSC, LIMIFT, LIMIH, LIMILINE, LIMILINESTA, LIMILO, LIMIMARGAMP, LIMIMARGSTA, LIMIMIRROR, LIMIMODE, LIMINUM, LIMIREL, LIMISEG, LIMISEGT, LIMITEST, SEGDEL, SENTER, SENTERT**

Example

```
OUTPUT 718; "LIMINUM LIMIT_1;"
OUTPUT 718; "LIMIFRQSC LIN;"
OUTPUT 718; "LIMIAMPSC LOG;"
```

Description

The LIMAMPSC command specifies whether the limit line is derived from a logarithmic or linear amplitude axis. Use LIN to set the amplitude axis to linear and LOG to set the amplitude axis to logarithmic. The LIMINUM command must be issued prior to issuing the LIMAMPSC command.

Query Response

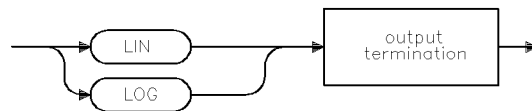

qq5

LIMIDEL

Delete Limit-Line Table

Deletes segments in the current limit-line table.

Syntax



XLIMIDEL .

Equivalent Softkey: **DELETE LIMIT , PURGE LIMITS**

Related Commands: LIMIAMPSCL, LIMIDISP, LIMIFAIL, LIMIFRQSCL, LIMIFT, LIMIH, LIMILINE, LIMILINESTA, LIMILO, LIMIMARGAMP, LIMIMARGSTA, LIMIMIRROR, LIMIMODE, LIMINUM, LIMIREL, LIMISEG, LIMISEGT, LIMITEST, SEGDEL, SENTER, SENTERT

Example

```
OUTPUT 718;"LIMIDEL;"
```

Description

The LIMIDEL command deletes the selected limit-line table specified by LIMINUM.

Note Use STOR or SAVET if you want to save the current limit-line table. LIMIDEL does not affect stored limit-line data.

LIMIDISP Limit Line Display

Controls when the limit lines are displayed.

Note Signal analysis mode only.

Syntax

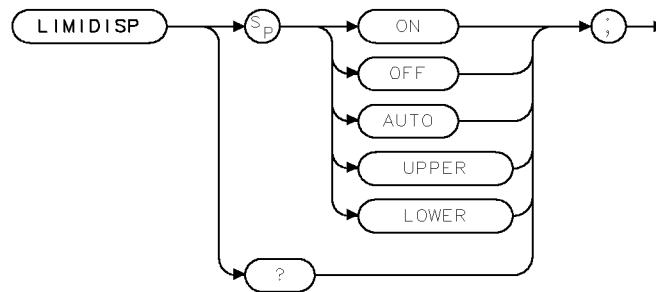

XLIMIDISP

Equivalent Softkey: `LMT DISP Y N AUTO`

Preset Value: AUTO

Related Commands: LIMIAMPSCL, LIMIDEL, LIMIFAIL, LIMIFRQSCL, LIMIFT, LIMIH1, LIMILINE, LIMILO, LIMIMIRROR, LIMIMODE, LIMIREL, LIMISEG, LIMISEGT, LIMITEST, SEGDEL, SENTER, SENTERT

Example

OUTPUT 718;"LIMIDISP ON;" *Displays any portion of the limit lines that are currently within the screen boundaries.*

Description

The LIMIDISP command controls when the limit line (or limit lines) are displayed. If a limit line is currently in internal memory, you can use LIMIDISP to control the display of the limit lines. The parameters of LIMIDISP do the following:

- ON Turns on the limit line display.
- OFF Turns off the limit line display.
- AUTO Allows LIMITEST to control the display of the limit lines. If LIMITEST is on, the limit lines will be displayed. If LIMITEST is off, the limit lines will not be displayed.
- UPPER Displays the upper limit line only.
- LOWER Displays the lower limit line only.

LIMIDISP Limit Line Display

When used as a predefined variable, LIMIDISP returns a number from 0 to four, depending on the setting of the LIMIDISP parameter. The number corresponds to the LIMIDISP parameter as shown in the following table.

LIMIDISP Parameter	Value Returned
OFF	0
UPPER	1
LOWER	2
ON	3
AUTO	4

Query Response

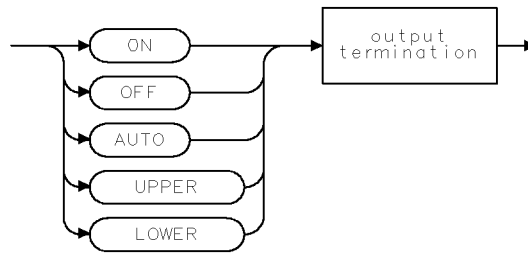

QLIMIDISP

LIMIFAIL Limits Failed

Returns the status of limit-line testing.

Syntax

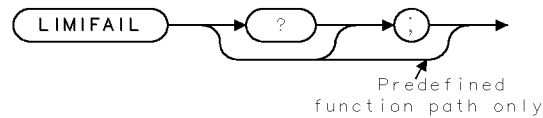

XLIMIFAIL

Related Commands: LIMIAMPSCL, LIMIDEL, LIMIDISP, LIMIFRQSCL, LIMIFT, LIMIH1, LIMILINE, LIMILINESTA, LIMILO, LIMIMARGAMP, LIMIMARGSTA, LIMIMIRROR, LIMIMODE, LIMINUM, LIMIREL, LIMISEG, LIMISEGT, LIMITEST, SEGDEL, SENTER, SENTERT

Related Softkey: **LMT TEST ON OFF**

Example

10	OUTPUT 718;"IP;SNGLS;CF300MHZ;SP100MHZ;"	<i>Initializes instrument and changes the frequency and span settings.</i>
20	OUTPUT 718;"LIMIDEL;"	<i>Deletes any limit-line tables, sets the table type to fixed.</i>
30	OUTPUT 718;"LIMIMODE UPPER;"	<i>Specifies the upper limit-line table.</i>
40	OUTPUT 718;"LIMISEG 250MHZ,-60DB,FLAT;"	<i>Creates an entry for the upper limit-line table. Because the LIMISEG command is used, the limit-line will be based on the frequency.</i>
50	OUTPUT 718;"LIMISEG 290MHZ,-60DB,SLOPE;"	
60	OUTPUT 718;"LIMISEG 295MHZ,-15DB,FLAT;"	
70	OUTPUT 718;"LIMISEG 305MHZ,-15DB,SLOPE;"	
80	OUTPUT 718;"LIMISEG 310MHZ,-60DB,FLAT;"	
90	OUTPUT 718;"LIMISEG 910MHZ,-60DB,FLAT;"	
100	OUTPUT 718;"LIMITEST ON;TS;"	<i>Turns on limit-line testing.</i>
110	OUTPUT 718;"LIMIFAIL?;"	<i>Returns the status of the limit-line testing.</i>
120	ENTER 718;A	
130	DISP A	<i>Displays the result.</i>
140	END	

LIMIFAIL Limits Failed

Description

The LIMIFAIL command returns one of the following values:

- 0 indicates that the measurement sweep was within the limit-line bounds.
- 1 indicates that the measurement sweep failed the lower limit, or LIMIT_2 and its related margin.
- 2 indicates that the measurement sweep failed the upper limit, or LIMIT_1 and its related margin.
- 3 indicates that the measurement sweep failed both the lower and upper limits.
- 4 indicates that no test was performed. A “4” is returned if LIMITEST is set to OFF.

Query Response

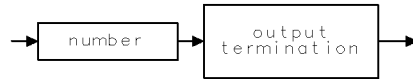

001

LIMIFRQSCL Limit-Line Frequency Scale

Specifies the limit-line frequency axis definition as logarithmic or linear.

Syntax

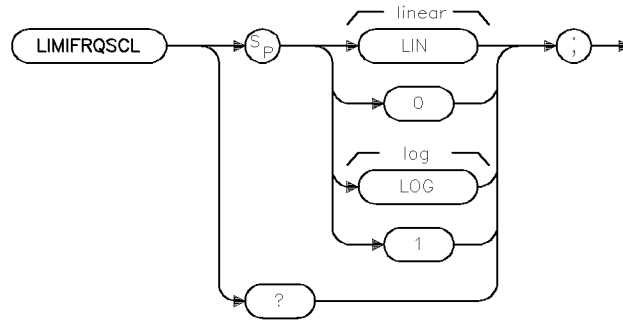

xlimifre

Equivalent Softkey: **FREQ SCL LOG LIN**

Prerequisite Command: LIMINUM, LIMIAMPSCL

Related Commands: LIMIAMPSCL, LIMIDEL, LIMIDISP, LIMIFAIL, LIMIFT, LIMIH, LIMILINE, LIMILINESTA, LIMILO, LIMIMARGAMP, LIMIMARGSTA, LIMIMIRROR, LIMIMODE, LIMINUM, LIMIREL, LIMISEG, LIMISEGT, LIMITEST, SEGDEL, SENTER, SENTERT

Example

```
OUTPUT 718; "LIMINUM LIMIT_1;"
OUTPUT 718; "LIMIAMPSCL LIN;"
OUTPUT 718; "LIMIFRQSCL LOG;"
```

Description

The LIMIFRQSCL command specifies whether the limit line is derived from a logarithmic or linear frequency axis. Use LIN to set the frequency axis to linear and LOG to set the frequency axis to logarithmic. The LIMINUM command must be issued prior to issuing the LIMIFRQSCL command.

Query Response

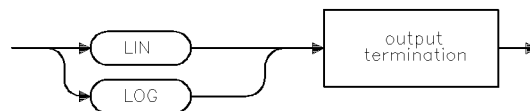

qq5

LIMIFT

Select Frequency or Time Limit Line

Selects how the limit-line segments are defined.

Note Signal analysis mode only.

Syntax

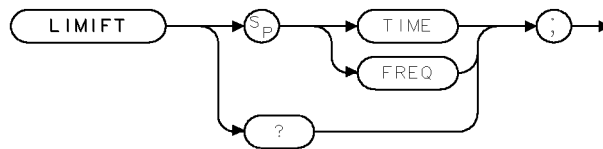

XLIMIFT .

Equivalent Softkey: **LIMITS FRQ TIME**

Related Commands: LIMIAMPSCL, LIMIDEL, LIMIDISP, LIMIFAIL, LIMIFRQSCL, LIMIH1, LIMILINE, LIMILO, LIMIMIRROR, LIMIMODE, LIMINUM, LIMIREL, LIMISEG, LIMISEGT, LIMITEST, SEGDEL, SENTER, SENTERT

Example

OUTPUT 718;"LIMIFT TIME;" *If the current limit-line table is a frequency limit-line table, it is purged. LIMIFT TIME places the limit-line segments on the display with respect to the sweep time of the instrument.*

Description

The LIMIFT command selects how the limit-line segments are defined: according to frequency, or according to the sweep-time setting of the instrument.

If you execute "LIMIFT TIME; ", LIMISEGT, or SENTERT, the limit-line segments are placed on the display with respect to the sweep time setting of the instrument. If you execute "LIMIFT FREQ; ", LIMISEG, or SENTER, the limit-line segments are placed according to the frequency that is specified for each segment. If a limit line has already been defined, changing the LIMIFT setting clears the existing limit line.

Query Response

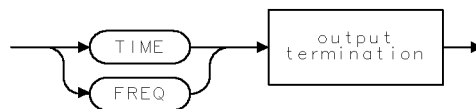

QLIMIFT .

LIMIHI Upper Limit

Specifies a fixed trace as the upper limit line or limit 1.

Syntax

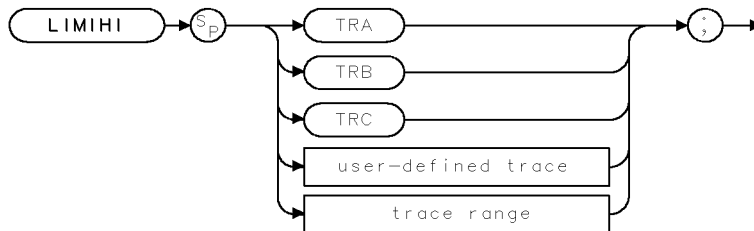

XLIMIHI .

Related Commands: LIMIAMPSCL, LIMIDEL, LIMIDISP, LIMIFAIL, LIMIFRQSCL, LIMIFT, LIMILINE, LIMILINESTA, LIMILO, LIMIMARGAMP, LIMIMARGSTA, LIMIMIRROR, LIMIMODE, LIMIREL, LIMISEG, LIMISEGT, LIMITEST, SEGDEL, SENTER, SENTERT

Example

10	OUTPUT 718;"TRDEF M_ASK,401;"	<i>Defines a trace called "M_ASK."</i>
20	OUTPUT 718;"MOV M_ASK[1,100],1000;"	<i>Moves values into sections of the M_ASK trace.</i>
30	OUTPUT 718;"MOV M_ASK[101,200],2000;"	
40	OUTPUT 718;"MOV M_ASK[201,300],3000;"	
50	OUTPUT 718;"MOV M_ASK[301,401],4000;"	
60	OUTPUT 718;"LIMIHI M_ASK;"	<i>Specifies M_ASK as the upper limit line.</i>
70	OUTPUT 718;"LIMITEST ON;"	<i>Turns on limit-line testing.</i>
80	OUTPUT 718;"LIMIFAIL?;"	<i>Tests if trace A fails limit-line testing.</i>
90	ENTER 718;A	
100	DISP A	<i>Displays result of limit-line testing.</i>
110	END	

LIMIHI Upper Limit

Description

The LIMIHl command specifies a fixed trace as the upper limit line or limit 1. Unlike specifying a limit line with LIMISEG, LIMISEGT, SENTER, or SENTERT, the limit line specified with LIMIHl is *not* updated if the center frequency, frequency span, sweep time, or reference level are changed.

Note Executing IP, LIMIDEL, LIMISEG, LIMISEGT, SENTER, or SENTERT will delete the limit line specified with LIMILO or LIMIHl. Executing LIMILO or LIMIHl will delete the limit line specified with LIMISEG, LIMISEGT, SENTER, or SENTERT.

Use LIMIDISP ON to display the limit line trace specified by LIMIHl. Use LIMIDISP OFF to blank the limit line trace specified by LIMIHl.

LIMILINE Limit Lines

Outputs the current limit-line table definitions.

Syntax

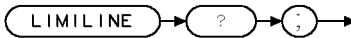

XLIMILINE

Related Commands: LIMIAMPSCL, LIMIDEL, LIMIDISP, LIMIFAIL, LIMIFRQSCL, LIMIFT, LIMIMIHI, LIMILINESTA, LIMILO, LIMIMARGAMP, LIMIMARGSTA, LIMIMIRROR, LIMIMODE, LIMINUM, LIMIREL, LIMISEG, LIMISEGT, LIMITEST, SEGDEL, SENTER, SENTERT

Example

10	DIM States\$[2000]	<i>Dimensions an array to store the limit-line information.</i>
20	OUTPUT 718;"IP;CF300MHZ;SP100MHZ;"	<i>Initializes instrument.</i>
30	OUTPUT 718;"LIMIDEL;"	<i>Deletes any limit-line tables, sets the table type to fixed.</i>
40	OUTPUT 718;"LIMIMODE UPPER;"	<i>Specifies the upper limit-line table.</i>
45	OUTPUT 718;"LIMIFT FREQ;"	<i>Selects a limit line based on frequency.</i>
50	OUTPUT 718;"LIMISEG 250MHZ,-60DB,FLAT;"	<i>Enters a value for the upper limit-line table. Because the LIMISEG command is used, the limit-line segment is for a limit-line based on frequency.</i>
60	OUTPUT 718;"LIMISEG 290MHZ,-60DB,SLOPE;"	
70	OUTPUT 718;"LIMISEG 295MHZ,-15DB,FLAT;"	
80	OUTPUT 718;"LIMISEG 305MHZ,-15DB,SLOPE;"	
90	OUTPUT 718;"LIMISEG 310MHZ,-60DB,FLAT;"	
100	OUTPUT 718;"LIMISEG 910MHZ,-60DB,FLAT;"	
110	OUTPUT 718;"LIMILINE?;"	<i>Gets the current limit-line table definitions.</i>
120	ENTER 718 USING "#,-K";States\$	<i>Enters information into array.</i>
130	PRINT States\$	<i>Prints the current limit-line table definitions.</i>
140	END	

LIMILINE Limit Lines

Description

The LIMILINE command is used to query the current limit line. Executing LIMILINE returns an ASCII string containing the commands needed to create the limit line.

Use these commands (in the order given) to build a limit line:

1. Use LIMIDEL to clear the limit-line table.
2. Use LIMIFT to select a limit line that is either based on frequency or sweep time.
3. Use LIMIREL to determine whether the values of the limit line are absolute values or positioned relative to the reference-level and center-frequency settings.
4. Use LIMIMODE, LIMISEG, LIMISEGT, SENTER, SENTERT to enter the limit-line segments. (Use LIMISEG or SENTER for a limit-line based on frequency; use LIMISEGT or SENTERT for a limit-line based on sweep time.)
5. Use the LIMIDISP or LIMILINESTA command to select if the limit line is displayed or not.
6. Use the LIMITEST command to turn on limit-line testing.
7. Use the LIMIFAIL command to determine if the measurement sweep passed or failed the limit line boundaries.

Enabling limit-line testing: When limit testing is enabled, the segments in the current table are interpolated into the limit-line traces according to the current span and center frequency or sweep time of the instrument. After the sweep, each value in trace A is compared to its corresponding value in the limit-line traces. If the current limit-line table is empty (for instance after using the command LIMIDEL) and limit testing is enabled, then the limit-line traces are blanked and set to out-of-range values. By using the SUB, MKPK HI, and MKF? commands, you can read the point of greatest difference between the trace and limit line. See “LIMITEST” for more information about limit-line testing.

Saving the limit line table: Once you have built the limit line, you can save the limit-line table on the disk drive or in internal memory. Use the STOR command, to store the current limit-line table on the disk drive. Use SAVET, to store the limit-line table in internal memory.

Query Response

The query response is a character string consisting of LIMIDEFNTYP, LIMINUM, LIMIMARGAMP, LIMILINESTA, LIMIMARGSTA, LIMIAMPSCL, LIMIFRQSCL, LIMIDISP, LIMITEST, LIMILINE, LIMIREL, LIMIHAF, LIMISEG, LIMISEGT, SENTER, or SENTERT commands. (The LIMIHAF command is for backward compatibility; it is not used as an HP 8546A/HP 8542E EMI system programming command.)

LIMILINE Limit Lines

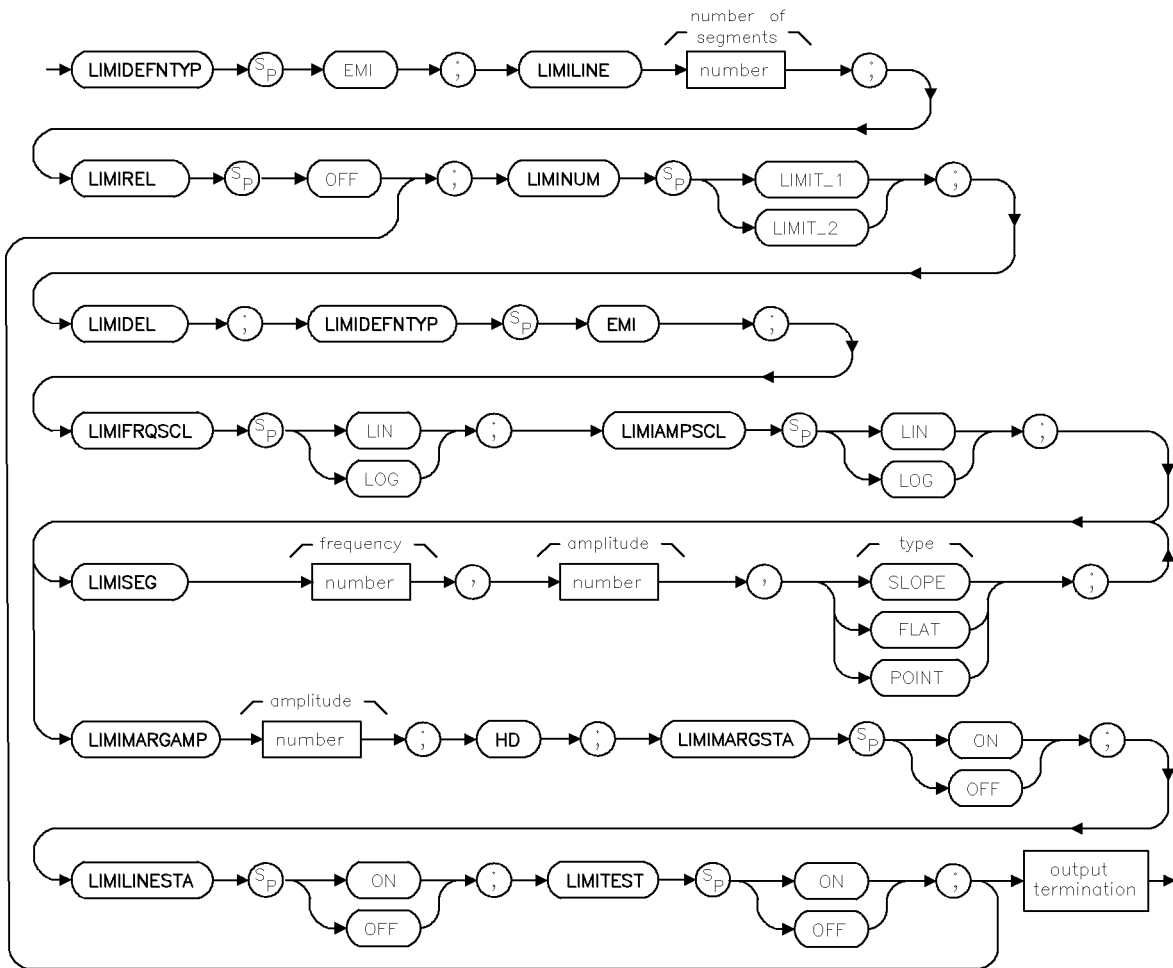

xlimiemi

LIMILINESTA

Limit-Line State

Displays the selected limit line.

Note EMI receiver mode only.

Syntax

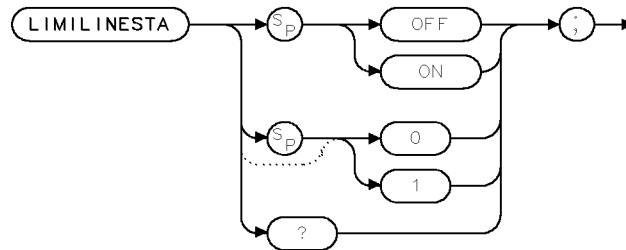

xlinsta .

Equivalent Softkeys: `LIMIT 1 ON OFF` or `LIMIT 2 ON OFF`

Prerequisite Command: `LIMINUM`

Preset State: `OFF`

Related Commands: `LIMIAMPSC`, `LIMIDEL`, `LIMIFAIL`, `LIMIFRQSCL`, `LIMIHI`, `LIMILINE`, `LIMILO`, `LIMIMARGAMP`, `LIMIMARGSTA`, `LIMINUM`, `LIMISEG`, `LIMITEST`, `SEGDEL`

Example

```
OUTPUT 718; "LIMINUM LIMIT_1;"  
OUTPUT 718; "LIMILINESTA ON;"
```

Description

The LIMILINESTA command displays the selected limit line. Setting LIMILINESTA to off disables the display of the selected limit line. Setting LIMILINESTA to on enables the display of the selected limit line. The LIMINUM command must be issued to select the limit line prior to issuing the LIMILINESTA command.

Note In order for limit-line testing to occur, LIMIMARGSTA or LIMILINESTA must be set to on.

Query Response

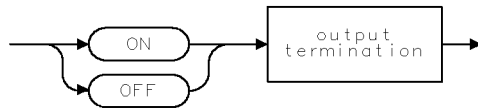

QQ2

LIMILO

Lower Limit

Specifies a fixed trace as the lower limit line or limit 2.

Syntax

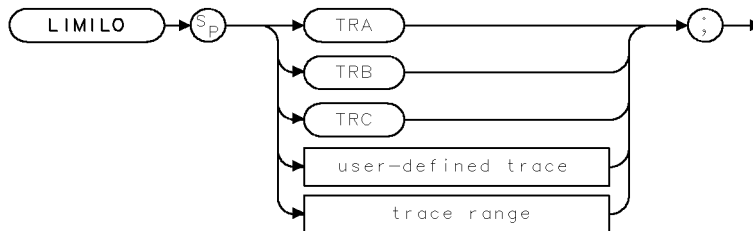

XLIMILO .

Related Commands: LIMIAMPSCL, LIMIDEL, LIMIDISP, LIMIFAIL, LIMIFRQSCL, LIMIFT, LIMIH1, LIMILINE, LIMILINESTA, LIMIMARGAMP, LIMIMARGSTA, LIMIMIRROR, LIMIMODE, LIMINUM, LIMIREL, LIMISEG, LIMISEGT, LIMITEST, SEGDEL, SENTER, SENTERT

Example

```
10  OUTPUT 718;"TRDEF M_ASK,401;"           Defines a trace called "M_ASK."
20  OUTPUT 718;"MOV M_ASK[1,100],1000;"     Moves values into sections of the M_ASK
                                           trace.

30  OUTPUT 718;"MOV M_ASK[101,200],2000;"
40  OUTPUT 718;"MOV M_ASK[201,300],3000;"
50  OUTPUT 718;"MOV M_ASK[301,401],4000;"
60  OUTPUT 718;"LIMILO M_ASK;"             Specifies M_ASK as the lower limit
                                           line.

70  OUTPUT 718;"LIMITEST ON;"              Turns on limit-line testing.
80  OUTPUT 718;"LIMIFAIL?;"               Tests if trace A fails limit-line testing.
90  ENTER 718;A
100 DISP A                                 Displays result of limit-line testing.
110 END
```

Description

The LIMILO command specifies a fixed trace as the lower limit line or limit 2. Unlike specifying a limit line with LIMISEG, LIMISEGT, SENTERT, or SENTER, the limit line specified with LIMILO is *not* updated if the center frequency, frequency span, sweep time, or reference level is changed.

Note Executing IP, LIMIDEL, LIMISEG, LIMISEGT, SENTERT, or SENTER will delete the limit line specified with LIMILO or LIMIH1. Executing LIMILO or LIMIH1 will delete the limit line specified with LIMISEG or SENTER.

Use LIMIDISP ON to display the limit line trace specified by LIMILO. Use LIMIDISP OFF to blank the limit line trace specified by LIMILO.

LIMIMARGAMP Limit Margin Amplitude

Sets the amplitude in negative dB for the limit margin.

Note EMI receiver mode only.

Syntax

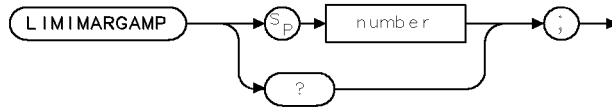

xLimamp .

Item	Description/Default	Range
Number	Any real or integer. Units are in decibels	-40 dB to 0 dB.

Equivalent Softkey: MARGIN 1 ON OFF or MARGIN 2 ON OFF

Prerequisite Command: LIMINUM

Preset State: 0.00 dB

Related Commands: LIMIAMPSCL, LIMIDEL, LIMIFAIL, LIMIFRQSCL, LIMIMI, LIMILINE, LIMILO, LIMILINESTA, LIMIMARGSTA, LIMINUM, LIMITEST, SEGDEL

Example

```
OUTPUT 718; "LIMINUM LIMIT_1;"
OUTPUT 718; "LIMIMARGAMP -3DB;"
```

Description

The LIMIMARGAMP command sets the amplitude (in negative decibels) for the limit margin. The limit margin is a fixed amplitude relative to the limit line. The LIMINUM command must be issued to select the limit margin prior to issuing the LIMIMARGAMP command and a limit line must be defined for limit margin to be active.

Query Response

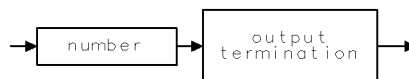

Q01 .

LIMIMARGSTA

Limit-Margin State

Displays the selected limit margin.

Note EMI receiver mode only.

Syntax

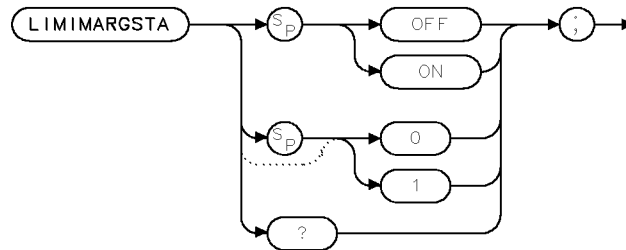

xLimr st .

Equivalent Softkey: **MARGIN 1 ON OFF** or **MARGIN 2 ON OFF**

Prerequisite Command: LIMINUM

Related Commands: LIMIAMPSCL, LIMIDEL, LIMIFAIL, LIMIFRQSCL, LIMIH1, LIMILINE, LIMILO, LIMILINESTA, LIMIMARGAMP, LIMINUM, LIMISEG, LIMITEST, SEGDEL

Example

```
10 OUTPUT 718; "LIMINUM LIMIT_1;"
20 OUTPUT 718; "LIMILINESTA ON;"
30 OUTPUT 718; "LIMIMARGSTA ON;"
```

Description

The LIMIMARGSTA command displays the selected limit margin. Setting LIMIMARGSTA to 0 or OFF disables the display of the selected limit margin. Setting LIMIMARGSTA to 1 or ON enables the display of the selected limit margin. The LIMINUM command must be issued to select the limit margin prior to issuing the LIMIMARGSTA command.

Note In order for limit-line testing to a margin to occur, LIMIMARGSTA or LIMILINESTA must be set to on.

Query Response

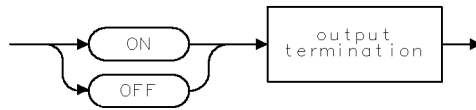

QQ2

LIMIMIRROR

Mirror Limit Line

Reflects the current definition about the amplitude axis at the largest frequency or sweep time.

Note Signal analysis mode only.

Syntax

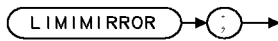

XLIMIMIRROR

Related Commands: LIMIAMPSCL, LIMIDEL, LIMIDISP, LIMIFAIL, LIMIFRQSCL, LIMIFT,
LIMIHI, LIMILINE, LIMILO, LIMIMODE, LIMIREL, LIMISEG,
LIMISEGT, LIMITEST, SEGDEL, SENTER, SENTERT

Example

10	OUTPUT 718;"IP;CF300MHZ;SP100MHZ;"	<i>Initializes instrument, changes the frequency and span.</i>
20	OUTPUT 718;"LIMIDEL;"	<i>Deletes any limit-line tables, sets the table type to fixed.</i>
30	OUTPUT 718;"LIMIMODE UPPER;"	<i>Specifies the upper limit-line table.</i>
35	OUTPUT 718;"LIMIFT FREQ;"	<i>Selects a limit line based on frequency.</i>
40	OUTPUT 718;"LIMISEG 250MHZ,-60DB,FLAT;"	<i>Enters a value into the upper limit-line table.</i>
50	OUTPUT 718;"LIMISEG 290MHZ,-50DB,SLOPE;"	
60	OUTPUT 718;"LIMISEG 295MHZ,-15DB,SLOPE;"	
70	OUTPUT 718;"LIMISEG 300MHZ,-10DB,SLOPE;"	
80	OUTPUT 718;"LIMIMIRROR;"	<i>Mirrors the upper limit-line entries.</i>
90	OUTPUT 718;"LIMITEST ON;"	<i>Turns on the limit-line testing and displays the limit lines.</i>
100	END	

LIMIMIRROR Mirror Limit Line

The example results in the limit-line table shown in the following table.

SEG	START_FREQ	UPPER_AMP	TYPE
1	250.0 MHz	-60.0 dBm	FLAT
2	290.0 MHz	-60.0 dBm	SLOPE
3	295.0 MHz	-15.0 dBm	SLOPE
4	300.0 MHz	-10.0 dBm	SLOPE
5	305.0 MHz	-15.0 dBm	SLOPE
6	310.0 MHz	-50.0 dBm	POINT
7	310.0 MHz	-60.0 dBm	FLAT
8	350.0 MHz	-60.0 dBm	FLAT

Description

Reflects the current definition about the amplitude axis at the largest frequency (for a limit line based on frequency) or the largest sweep time (for a limit line based on the sweep time) in the definition.

You may notice that the LIMIMIRROR command may create more than one table entry for a frequency (for example, see segment 6 in the above table). The LIMIMIRROR command creates an extra segment so that the previous segment is explicitly ended at the correct amplitude.

LIMIMODE

Limit-Line Entry Mode

Determines how the limit-line entries are treated.

Note Signal analysis mode only.

Syntax

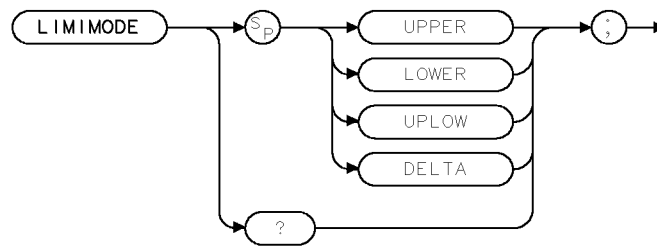

XLIMIMODE

Related Commands: LIMIAMPSCL, LIMIDEL, LIMIDISP, LIMIFAIL, LIMIFRQSCL, LIMIFT, LIMIMI, LIMILINE, LIMILO, LIMIMIRROR, LIMIREL, LIMISEG, LIMISEGT, LIMITEST, SEGDEL, SENTER, SENTERT

Example

This example uses LIMIMODE to enter segments into the upper limit-line table, and then to enter a segment into the lower limit-line table (upper and lower limit lines are treated as separate tables). Line 80 demonstrates entering a segment into a combined upper and lower limit-line table.

<pre> 10 OUTPUT 718;"LIMIDEL;" 20 OUTPUT 718;"LIMIMODE UPPER;" 30 OUTPUT 718;"LIMIFT FREQ;" 40 OUTPUT 718;"LIMISEG 300MHZ,-30DB,SLOPE;" 50 OUTPUT 718;"LIMIMODE LOWER;" 60 OUTPUT 718;"LIMISEG 300MHZ,-70DB,SLOPE;" 70 OUTPUT 718;"LIMIMODE UPLOW;" 80 OUTPUT 718;"SENER 350MHZ,-30DB,-80DB,FLAT;" 90 OUTPUT 718;"LIMIDISP ON;" 100 END </pre>	<p><i>Deletes the current limit-line table, sets the table type to fixed.</i></p> <p><i>Specifies the upper limit-line table.</i></p> <p><i>Selects a limit line based on frequency.</i></p> <p><i>Enters a segment into the upper limit-line table. Because the LIMISEG command is used, the limit-line table will be based on frequency.</i></p> <p><i>Specifies the lower limit-line table.</i></p> <p><i>Enters a segment into the lower limit-line table.</i></p> <p><i>Specifies the upper and lower limit-line tables.</i></p> <p><i>Enters a segment into the upper and lower limit-line tables.</i></p> <p><i>Displays the limit lines.</i></p>
--	--

Description

The LIMIMODE command determines whether the limit-line entries are treated as upper-amplitude values, lower-amplitude values, upper and lower amplitude values, or mid-amplitude and delta values.

Use LIMIMODE in conjunction with LIMISEG, LIMISEGT, SENTER, or SENTERT. Specify LIMIMODE UPPER or LIMIMODE LOWER before using LIMISEG or LIMISEGT. Specify LIMIMODE UPLOW or LIMIMODE DELTA before using SENTER or SENTERT.

The LIMIMODE command determines whether the limit-line table entries are to be treated separately (upper or lower) or together (upper and lower) when deleting a segment with SEGDEL (see "SEGDEL"). If limit-line table entries are entered with LIMISEG or LIMISEGT, they are treated as entries to separate tables even if LIMIMODE UPLOW or LIMIMODE DELTA had been previously specified.

When used as a predefined variable, LIMIMODE returns a number from 0 to three, depending on the setting of the LIMIMODE parameter. The number corresponds to the LIMIMODE parameter as shown in the following table.

LIMIMODE Parameter	Value Returned
UPLOW	0
DELTA	1
UPPER	2
LOWER	3

Query Response

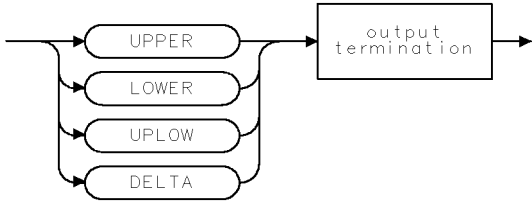

QLIMIMODE

LIMINUM

Limit-Line Number

Selects limit-line number 1 or 2 and its corresponding margin.

Note EMI receiver mode only.

Syntax

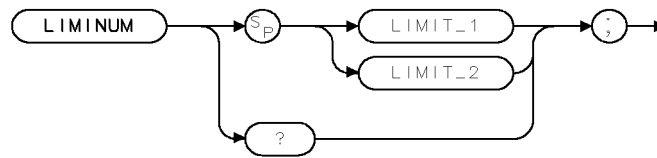

xLimnum .

Equivalent Softkey: `Limit 1` or `Limit 2`

Preset State: `LIMIT_1`

Related Commands: `LIMIAMPSC`, `LIMIDEL`, `LIMIFAIL`, `LIMIFRQSCL`, `LIMIHI`, `LIMILINE`, `LIMILO`, `LIMILINESTA`, `LIMIMARGAMP`, `LIMIMARGSTA`, `LIMISEG`, `LIMITEST`, `SEGDEL`

Example

```
OUTPUT 718; "LIMINUM LIMIT_1;"
```

Description

The LIMINUM command selects limit-line number 1 or 2 and its corresponding margin. This command must be issued prior to issuing any of the related commands listed above.

Query Response

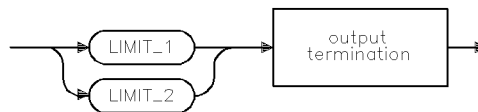

qLimnum .

LIMIREL Relative Limit Lines

Specifies whether the current limit lines are fixed or relative.

Note Signal analysis mode only.

Syntax

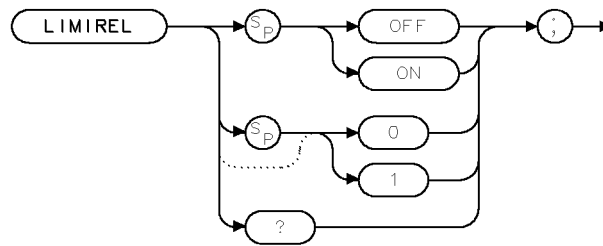

XLIMIREL

Equivalent Softkey: **LIMITS FIX REL**

Related Commands: LIMIAMPSCL, LIMIDEL, LIMIDISP, LIMIFAIL, LIMIFRQSCL, LIMIFT, LIMIH1, LIMILINE, LIMIO, LIMIMIRROR, LIMIMODE, LIMISEG, LIMISEGT, LIMITEST, SEGDEL, SENTER, SENTERT

Example

OUTPUT 718;"LIMIFT FREQ;" *Selects a limit line based on frequency.*
 OUTPUT 718;"LIMIREL ON;" *Specifies that the limit line will be relative to the reference-level and center-frequency settings.*

Description

The LIMIREL command specifies whether the current limit lines are fixed or relative. Use the LIMIFT command to select whether the limit lines are based on frequency or sweep time before using LIMIREL, because changing between a frequency or sweep time limit line purges the current limit line table and sets LIMIREL to OFF.

LIMIREL and the reference level: Regardless of whether the limit line is based on frequency or sweep time, LIMIREL determines if the amplitude parameter in a limit line table represents absolute values or relative values. If LIMIREL is set to OFF, the limit lines amplitude values are specified in absolute amplitude and do not depend on the reference level (RL) setting. If LIMIREL is set to ON, the limit line amplitude values are relative to the current reference level (RL) setting.

For limit lines that are based on frequency: The LIMIREL command determines whether the frequency parameter in a limit-line table represent absolute or relative values that are referenced to the center-frequency settings.

- Executing "LIMIREL OFF;" specifies that the frequency values in a limit-line table are fixed values, and the limit line is positioned accordingly. Fixed limit lines are specified in absolute frequency and do not depend upon the center frequency value.

LIMIREL Relative Limit Lines

- Executing “LIMIREL ON;” specifies that the frequency values in a limit-line table are relative values and positions the limit line relative to the center-frequency settings. Relative limit lines are specified in relative frequency and are positioned with respect to the current center frequency. When the current center frequency value is changed, the segment frequencies are converted according to the current center frequency value.

For limit lines that are based on the sweep time: Limit lines that are based on sweep time are always relative to the start time, and the horizontal position of the limit line is not affected by the setting of LIMIREL.

Query Response

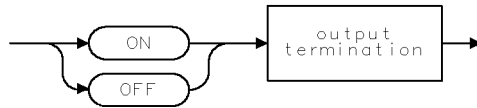

002

LIMISEG Enter Limit-Line Segment for Frequency

Adds new segments to the current frequency limit line.

Syntax

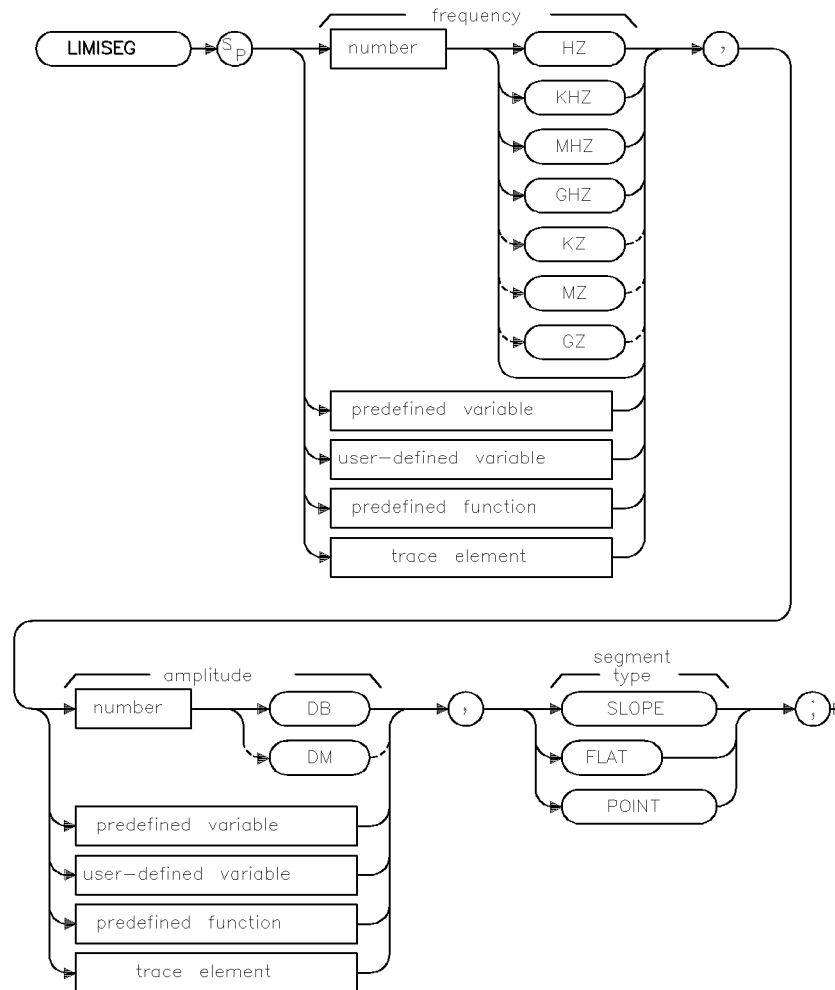

xlimiseg

Item	Description/Default	Range
Number	Any real or integer number. Default unit is dBm.	Varies with FOFFSET and ROFFSET.

Related Commands: LIMIAMPSCL, LIMIDEL, LIMIDISP, LIMIFAIL, LIMIFRQSCL, LIMIFT, LIMIMI, LIMILINE, LIMILINESTA, LIMILO, LIMIMARGAMP, LIMIMARGSTA, LIMIMIRROR, LIMIMODE, LIMINUM, LIMIREL, LIMISEGT, LIMITEST, SEGDEL, SENTER, SENTERT

LIMISEG Enter Limit-Line Segment for Frequency

Example

10	OUTPUT 718;"IP;SNGLS;CF300MHZ;SP100MHZ;IFBW 3MHZ;"	<i>Initializes instrument, changes the frequency, span, and bandwidth.</i>
20	OUTPUT 718;"LIMIDEL;"	<i>Deletes the current limit-line table, sets the table type to fixed.</i>
30	OUTPUT 718;"LIMIMODE UPPER;"	<i>Specifies the upper limit-line table.</i>
35	OUTPUT 718;"LIMIIFT FREQ;"	<i>Selects a limit line based on frequency.</i>
40	OUTPUT 718;"LIMISEG 250MHZ,-60DB,FLAT;"	<i>Adds segment to the upper limit-line table.</i>
50	OUTPUT 718;"LIMISEG 290MHZ,-60DB,SLOPE;"	
60	OUTPUT 718;"LIMISEG 295MHZ,-15DB,FLAT;"	
70	OUTPUT 718;"LIMISEG 305MHZ,-15DB,SLOPE;"	
80	OUTPUT 718;"LIMISEG 310MHZ,-60DB,FLAT;"	
90	OUTPUT 718;"LIMISEG 910MHZ,-60DB,FLAT;"	
100	OUTPUT 718;"LIMIMODE LOWER;"	<i>Specifies the lower limit-line table.</i>
110	OUTPUT 718;"LIMISEG 250MHZ,-75DB,FLAT;"	<i>Adds segment to the lower limit-line table.</i>
120	OUTPUT 718;"LIMISEG 910MHZ,-75DB,FLAT;"	
130	OUTPUT 718;"LIMITEST ON;TS;"	<i>Enables limit-line testing.</i>
140	OUTPUT 718;"LIMIFAIL?;"	<i>Returns the result of limit-line testing.</i>
150	ENTER 718;A	
160	DISP A	<i>Displays the result.</i>
170	END	

Description

The LIMISEG command adds new segments to the current frequency limit line in either the upper limit line or the lower limit line. If the current limit line table contains lines based on sweep time (as opposed to a limit line based on the frequency), executing LIMISEG will clear the current sweep time limit line table, and set LIMIREL to OFF.

Each limit-line segment is specified with a starting frequency, an amplitude, and a segment type. The segment type defines how the line segment is to extend from its starting point to the next segment. The segment types are FLAT, SLOPE, and POINT.

- FLAT draws a zero-slope line between the coordinate point of the current segment and the coordinate point of the next segment, producing limit-line values equal in amplitude for all frequencies between the two points. If the amplitude values of the two segments differ, the limit line will “step” to the value of the second segment.
- SLOPE draws a straight line between the coordinate point of the current segment and the coordinate point of the next segment, producing limit-line values for all frequencies between the two points.
- POINT specifies a limit value for the coordinate point, and no other frequency points, so that a POINT segment specifies a limit value for a single frequency. The POINT segment type should be used as the last segment in the limit-line table. However, if the last segment in the

LIMISEG Enter Limit-Line Segment for Frequency

table is not specified as the POINT segment type, an implicit point is used automatically. If a visible POINT segment at the right edge of the display is not desired, add an explicit last point segment (higher in frequency than the stop frequency) to the limit-line table.

Segments are sorted according to starting frequency. A maximum of 30 segments can be defined in each of the upper and lower halves of a limit line. When the segment type is omitted, the last type given (or SLOPE if no previous type has been given) is used.

Use LIMISEG if you want to enter amplitude data in the upper or lower limit lines. If you want to enter amplitude data as upper and lower amplitude pairs or as mid and delta pairs, use the SENTER command instead of LIMISEG. Use LIMIMODE to specify entry into the upper limit-line table or the lower limit-line table (see line 30 of example).

LIMISEGT

Enter Limit-Line Segment for Sweep Time

Adds new segments to the current sweep time limit line.

Note Signal analysis mode only.

Syntax

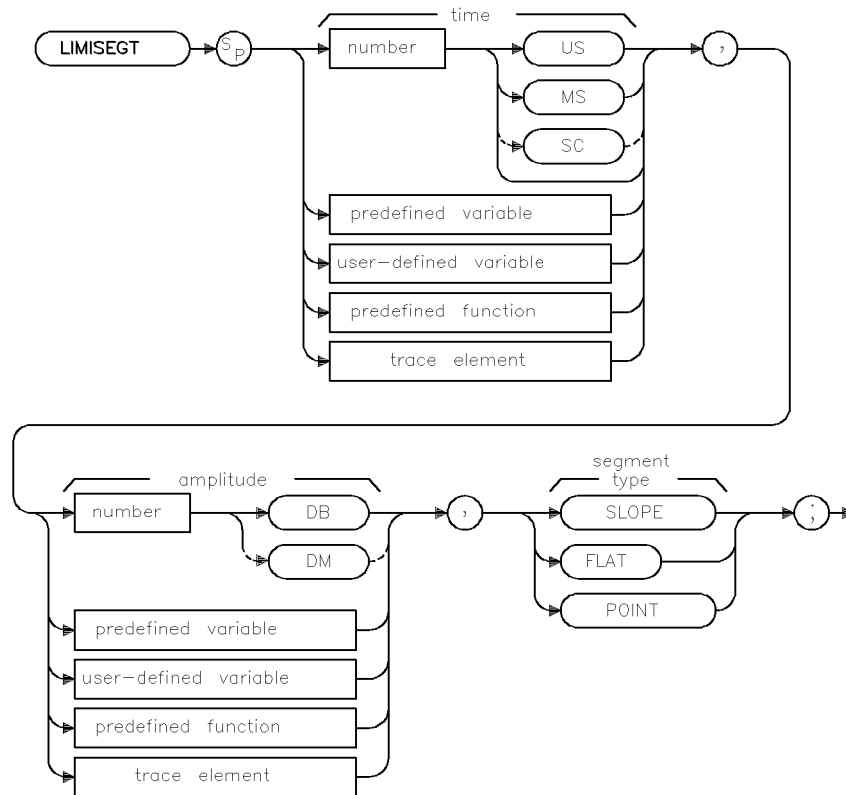

xlimisegt

Item	Description/Default	Range
Number	Any real or integer number. For the sweep time, the default unit is seconds. For the amplitude value, the default unit is dBm.	The range of the sweep time is 0 to 100 s. The range of the amplitude varies with ROFFSET.

Related Commands: LIMIAMPSCL, LIMIDEL, LIMIDISP, LIMIFAIL, LIMIFRQSCL, LIMIFT, LIMIMI, LIMILINE, LIMILO, LIMIMIRROR, LIMIMODE, LIMIREL, LIMISEG, LIMITEST, SEGDEL, SENTER, SENTERT

Example

OUTPUT 718;"LIMIDEL;"	<i>Deletes the current limit-line table, sets the table type to fixed.</i>
OUTPUT 718;"LIMIMODE UPPER;"	<i>Specifies the upper limit-line table.</i>
OUTPUT 718;"LIMIIFT TIME;"	<i>Selects a limit line based on the sweep time.</i>
OUTPUT 718;"LIMISEGT 0MS,-60DB,FLAT;"	<i>Adds segment to the upper limit-line table.</i>
OUTPUT 718;"LIMISEGT 6MS,-60DB,SLOPE;"	
OUTPUT 718;"LIMISEGT 8MS,-15DB,FLAT;"	
OUTPUT 718;"LIMISEGT 11MS,-20DB,SLOPE;"	
OUTPUT 718;"LIMISEGT 14MS,-60DB,FLAT;"	
OUTPUT 718;"LIMISEGT 20MS,-60DB,POINT;"	
OUTPUT 718;"LIMIMODE LOWER;"	<i>Specifies the lower limit-line table.</i>
OUTPUT 718;"LIMISEGT 0MS,-75DB,FLAT;"	<i>Adds segment to the lower limit-line table.</i>
OUTPUT 718;"LIMISEGT 20MS,-75DB,POINT;"	
OUTPUT 718;"LIMITEST ON;TS;"	<i>Enables limit-line testing.</i>
OUTPUT 718;"LIMIFAIL?;"	<i>Returns the result of limit-line testing.</i>
ENTER 718;A	
DISP A	<i>Displays the result.</i>

Description

The LIMISEGT command adds new segments to the current sweep time limit line in either the upper or lower limit line. Each limit-line segment is specified with a starting sweep time, an amplitude, and a segment type.

Note If the current limit line table contains limit lines based on frequency (as opposed to a limit line based on the sweep time), executing LIMISEGT will clear the current frequency limit line table, and set LIMIREL to OFF.

Starting sweep time: When you specify the starting sweep time, you are specifying the starting sweep time with respect to the sweep time of the instrument. For example, if you specify a starting sweep time of 0, the limit-line segment will start at the left side of the display.

Segment type: The segment type defines how the line segment is to extend from its starting point to the next segment. The segment types are FLAT, SLOPE, and POINT.

- FLAT draws a zero-slope line between the coordinate point of the current segment and the coordinate point of the next segment, producing limit-line values equal in amplitude for all sweep times between the two points. If the amplitude values of the two segments differ, the limit line will “step” to the value of the second segment.
- SLOPE draws a straight line between the coordinate point of the current segment and the coordinate point of the next segment, interpolating amplitude values for all sweep times between the two points.
- POINT specifies a limit value for the coordinate point, and no other sweep time points, so that a POINT segment specifies an amplitude value for a single sweep time. For an upper limit line, a POINT segment is indicated by a line drawn from the coordinate point, to a point that is vertically off the top of the graticule area. For a lower limit line, a POINT segment is indicated by a line drawn from the coordinate point, to a point that is vertically off the bottom of the graticule area. The POINT segment type should be used as the last segment in the limit-line table. However, if the last segment in the table is not specified as the POINT segment type, an implicit point is used automatically. If a visible POINT segment at the right

LIMISEGT Enter Limit-Line Segment for Sweep Time

edge of the display is not desired, add an explicit last point segment to (higher in sweep time than the current sweep time setting of the instrument) the limit-line table.

Segments are sorted according to starting sweep time. A maximum of 30 segments can be defined in each of the upper and lower halves of a limit line.

Use LIMISEGT if you want to enter amplitude data in the upper or lower limit lines. Use LIMIMODE to specify entry into the upper limit-line table or the lower limit-line table (see line 30 of example). If you want to enter amplitude data as upper and lower amplitude pairs or as mid and delta pairs, use the SENTERT command instead of LIMISEGT.

LIMITEST

Enable Limit-Line Testing

Enables testing to the displayed limit line and limit margin.

Syntax

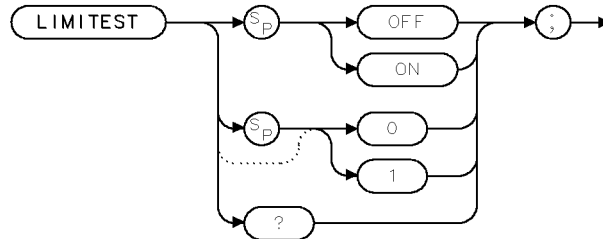

XLIMITEST

Equivalent Key: `LMT TEST ON OFF`

Prerequisite Command: LIMINUM

Preset State: OFF

Related Commands: LIMIAMPSCL, LIMIDEL, LIMIDISP, LIMIFAIL, LIMIFRQSCL, LIMIFT, LIMIH, LIMILINE, LIMILINESTA, LIMILO, LIMIMARGAMP, LIMIMARGSTA, LIMIMIRROR, LIMIMODE, LIMINUM, LIMIREL, LIMISEG, LIMISEGT, SEGDEL, SENTER, SENTERT

Example

```
OUTPUT 718; "LIMITEST ON;"
```

Description

The LIMITEST command enables testing to the displayed limit line and limit margin. Setting LIMITEST to 0 or OFF disables testing, and setting LIMITEST to 1 or ON enables testing.

EMI Receiver Mode Only

The LIMINUM command must be issued to select the limit line prior to issuing the LIMITEST command. LIMITEST may be independently turned on or off for LIMIT 1 and LIMIT 2.

Note *For EMI mode only.*

In order for limit-line testing to a margin to occur, LIMIMARGSTA or LIMILINESTA must be set to on.

LIMITEST Enable Limit-Line Testing

For signal analysis mode only.

LIMITEST ON turns testing on for both the upper and lower limits. LIMITEST OFF turns testing off for both the upper and lower limits.

Note Testing may be enabled even though the limit lines are not displayed.

Query Response

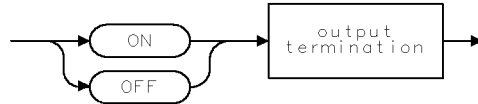

002

LINCHK Linearity Check

Determines whether a measured signal level is undergoing compression.

Syntax

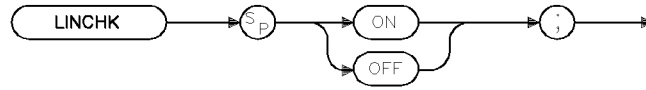

xlinchk

Equivalent Key: **LINEARITY CHECK**
 Related Commands: AT, RL, MKN, MKPK
 Preset State: LINCHK OFF

Example

OUTPUT 718; "LINCHK ON;"

Description

The LINCHK command modifies the input RF attenuation to allow the user to determine if a measured signal level is undergoing compression. The LINCHK command is designed to be used with the Marker subsystem in order to measure a specific signal level at different RF attenuation values.

Note An “illegal command” SRQ will be sent if you issue the “LINCHK ON” command and no additional RF attenuation is available from the system. In this case, the error message: "LINCHK: RF Attenuation at Max" will appear on the screen.

Query Response:

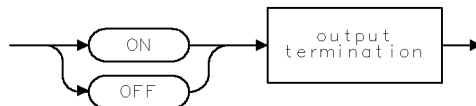

002

LINFILL

Linear

Fills linear interpolated data into the specified trace data points of a destination trace.

Syntax

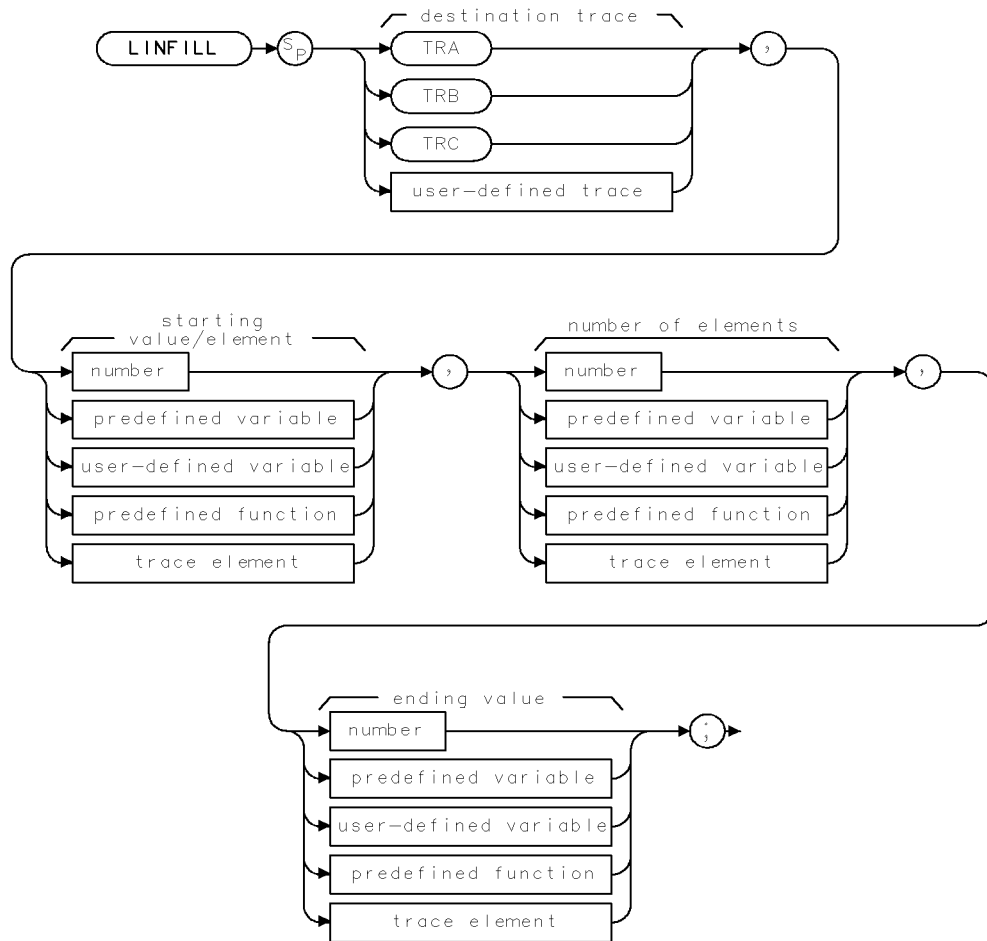

VI LINFILL

Item	Description/Default	Range
User-defined variable	A variable defined by VARDEF command.	Any valid variable name. For the starting value or number of elements, the range of the number is 0 to the length of the trace minus 1. For the ending value, the range is -32,768 to +32,767.
Predefined variable	A command that acts as a variable. Refer to Table 4-1.	
Predefined function	Function that returns a value. Refer to Table 4-1.	
Trace element	An element of trace A, trace B, trace C, or a user-defined trace.	
Number	Any valid integer number.	

Example

OUTPUT 718;"LINFILL TRC,0,0,0;"

Initializes trace C.

OUTPUT 718;"MOV TRC[1,10],TRA[1,10];"

Moves the first 10 elements of trace A into trace C.

OUTPUT 718;"LINFILL TRC,10,40,8000;"

Uses the 10th element of trace C as the starting value, fills trace C elements 11 through 50 with the interpolated data, and places ending value (8000) into the 50th element of trace C.

Description

The LINFILL command uses the starting value and the ending value to calculate the linear interpolation data (the values for ending value should be in measurement units). The “number of elements” field allows you to specify the number trace data points that are “filled in” with linear interpolation data. The number of elements field includes the starting element, so if the starting value is 10 and the number of elements is 40, the ending element will be 50.

The data will not be interpolated if the starting value is 0. If the starting value is 0, the ending value is copied into the first element of the destination trace. You may want to set the starting value to 0 to initialize a trace before using LINFILL to fill the trace with interpolated data. If the starting value and the number of elements exceed the length of the destination trace, the interpolation ends at the end of the trace array; the ending value is never reached.

LN

Linear Scale

Specifies the vertical graticule divisions as linear units.

Syntax

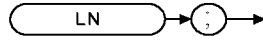

XLN

Equivalent Softkey: **SCALE LOG LIN**

Related Commands: LG, RL

Example

```
OUTPUT 718;"LN;"           Selects linear mode.
OUTPUT 718;"LN;RL 30MV;"
```

Description

The LN command scales the amplitude (vertical graticule divisions) proportionally to the input voltage, without changing the reference level. The bottom graticule line represents a signal level of zero volts.

Voltage entries are rounded to the nearest 0.1 dB. Thus, 30.16 mV becomes 89.6 dB μ V.

LOAD Load

Loads a file from the disk drive.

Syntax

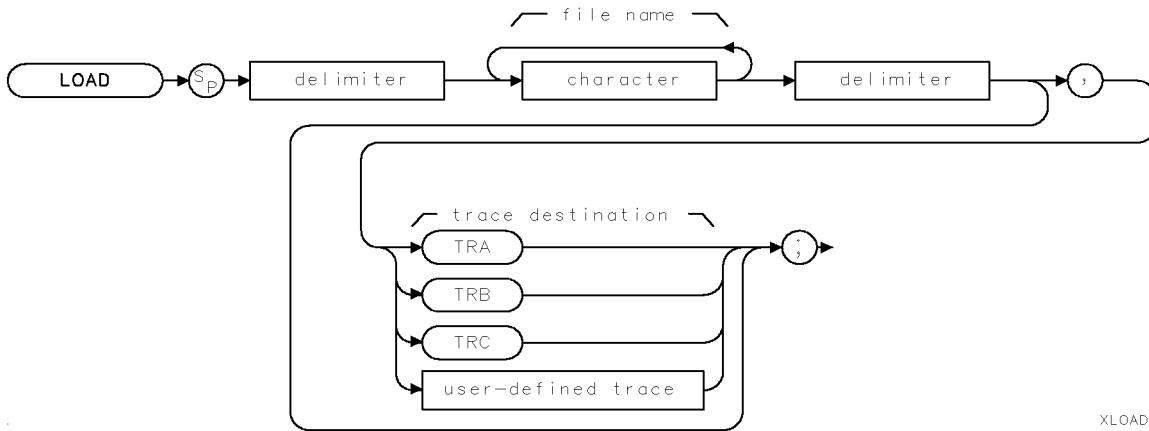

Item	Description/Default	Range
Character	Any valid character.	Any valid file name.
Delimiter	Matching characters marking the beginning and end of the list of instrument commands.	~ \ @ = / ^ \$ % ; ! ' : " &

Equivalent Softkey: **LOAD FILE**

Related Commands: CAT, STOR

Example

LIF Format

OUTPUT 718; "LOAD %tMYTRA%, TRA;"

Loads MYTRA from the disk drive into trace A.

OUTPUT 718; "LOAD %eMYSETUP%;"

Loads all information from MYSETUP.

DOS Format

OUTPUT 718; "LOAD %MYTRA.TRC%, TRA;"

Loads MYTRA from the disk drive into trace A.

OUTPUT 718; "LOAD %MYSETUP.ALL%;"

Loads all information from MYSETUP.

LOAD Load

Description

The LOAD command loads a file from the disk drive.

To use the LOAD command, you must specify the file name of the file to be loaded from the disk drive into internal memory, and, if you are loading trace data, you must also specify the trace destination.

file name: When Loading data from a floppy disk, you must specify the file name of the file to be loaded, in either LIF or DOS format. Specify a prefix for LIF format or a suffix for DOS format to indicate the data type (see the following table).

Table 4-6. LIF or DOS Data Types

LIF Prefix	DOS Suffix	File Description	Result
s	.STA	Instrument state	Loads the instrument state, and changes the current instrument state to the state that was loaded.
t	.TRC	Trace	Loads the trace and state. The current instrument trace and state is changed to the trace and state that was loaded.
l	.LIM	Limit lines	Loads the limit-line values into the current limit-line table.
g	.SIG	Signal list	Loads the signal list and its associated annotation.
n	.ANT	Antenna correction factors	Loads the antenna correction factors.
c	.CBL	Cable correction factors	Loads the cable correction factors.
o	.OTH	Other correction factors	Loads other correction factors.
e	.ALL	All information	Loads all information.

Destination: When recalling trace data, you need to specify either TRA, TRB, TRC, or a user-defined trace as the destination. Omit the destination parameter when recalling all other file types.

Note The LOAD command recalls data from the disk drive. Refer to “RCLT” or “RCLS” to recall data from internal memory.

LOG Logarithm

Takes the logarithm (base 10) of the source, multiplies the result by the scaling factor.

Syntax

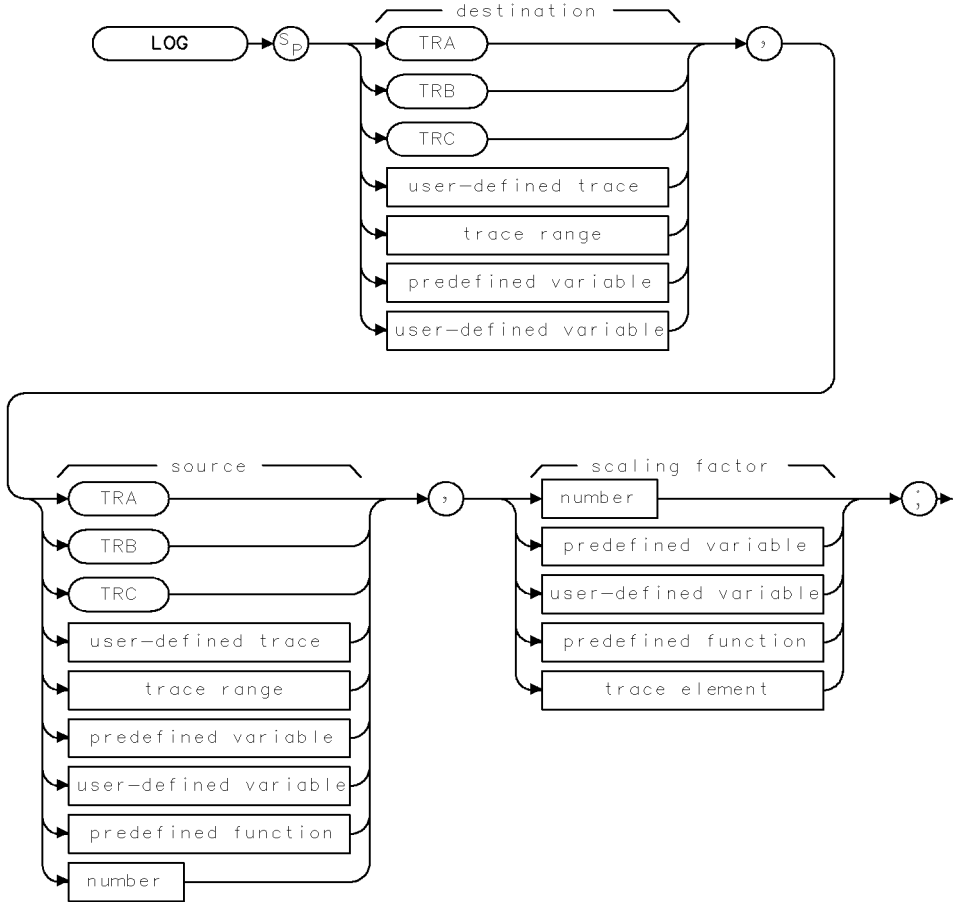

XLOG

Item	Description/Default	Range
User-defined trace	A trace defined by the TRDEF command.	Any valid trace name.
User-defined variable	A variable defined by VARDEF command.	
Predefined variable	A command that acts as a variable. Refer to Table 4-1.	
Predefined function	Function that returns a value. Refer to Table 4-1.	
Trace range	A segment of trace A, trace B, trace C, or a user-defined trace.	
Trace element	An element of trace A, trace B, trace C, or a user-defined trace.	
Number	Any real or integer number.	Real number range.

Prerequisite Commands: TRDEF when using a user-defined trace. VARDEF when using a user-defined variable. TS when using trace data.

Related Commands: EXP

LOG Logarithm

Example 1

OUTPUT 718;"IP;"	<i>Initializes instrument.</i>
OUTPUT 718;"VARDEF P_POWER,0;"	<i>Defines a user-defined variable, called P_POWER, and sets it equal to 0.</i>
OUTPUT 718;"LOG P_POWER,5,10;"	<i>P_POWER = 10 × LOG(5).</i>
OUTPUT 718;"P_POWER?;"	<i>Returns value to computer.</i>
ENTER 718;N	<i>Assigns value to computer variable.</i>
DISP USING "D.DD,K";N;" dB"	<i>Displays value on the computer screen.</i>

Example 2

This example finds the natural exponential of a number and uses the LOG function to return the original source value of the EXP function.

10 OUTPUT 718;"VARDEF E_XP,0;"	<i>Defines a variable called E_XP.</i>
20 OUTPUT 718;"EXP E_XP,2,2.30259;"	<i>Finds the natural exponential of 2.</i>
30 OUTPUT 718;"E_XP?;"	<i>Returns the natural exponential of 2.</i>
40 ENTER 718;Value	
50 PRINT Value	<i>Prints the value of the exponential.</i>
60 OUTPUT 718;"LOG E_XP,E_XP,2.30259;"	<i>Uses the log function on the exponential value.</i>
70 OUTPUT 718;"E_XP?;"	<i>The log of the exponential value is approximately 2.</i>
80 ENTER 718;Logvalue	
90 PRINT Logvalue	
100 OUTPUT 718;"VARDEF E_XPY,0;"	<i>Declares a variable called E_XPY.</i>
110 OUTPUT 718;"EXP E_XPY,-5,2.30259;"	<i>Finds the natural exponential of -5.</i>
120 OUTPUT 718;"E_XPY?;"	<i>Returns the value of the natural exponential of -5.</i>
130 ENTER 718;Value2	
140 PRINT Value2	<i>Prints the value of the exponential.</i>
150 OUTPUT 718;"LOG E_XPY,E_XPY,2.30259;"	<i>Uses the log function on the exponential value.</i>
160 OUTPUT 718;"E_XPY?;"	<i>The log of the exponential value is approximately -5.</i>
170 ENTER 718;Logval	
180 PRINT Logval	
190 END	

Description

The LOG command takes the logarithm (base 10) of the source, multiplies the result by the scaling factor, then stores it in the destination. The scaling factor may be used to improve numerical computations when calculating logarithms of integer trace data. For example, the log of a trace value of 8000 is 3.9, which would be stored as the value 4 in a trace.

The log of trace value of 1 is 0, so the log of a trace containing values from 1 to 8000 would be compressed to values 0, 1, 2, 3, 4. Computational accuracy can be improved by using the scaling factor to scale up the log values before they are stored. In this case, because 3.903 is the log of 8000 and the largest positive trace value is 32,767, a scaling factor of 32,767 divided by 3.903 or 8,395 may be applied to the data. Because EXP and LOG are inverse functions, the

LOG Logarithm

EXP command has a scaling factor that may be used to “undo” the scaling factor of the LOG command.

The LOG command can be used to calculate the natural logarithm by using 2.30259 as the scaling factor.

The LOG function returns an invalid result if the source is zero or a negative number.

When the source is longer than the destination, the source is truncated to fit. When the source is shorter than the destination, the last element is repeated to fill the destination.

LSPAN

Last Span

Changes the span of the instrument to the previous span setting.

Syntax

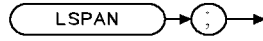

XLSPAN

Equivalent Softkey: **LAST SPAN**

Related Commands: SP

Example

```
OUTPUT 718;"LSPAN;"
```

Description

The LSPAN command changes the span of the instrument to the previous span setting.

LOGSWEEPSPD Log Sweep Speed

Sets the log sweep speed to fast or standard.

Syntax

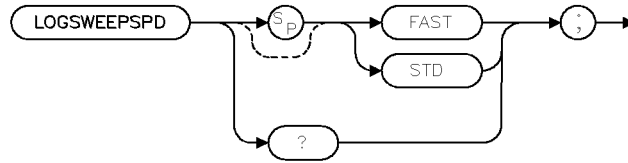

xloqswp

Equivalent Softkey: **LOGF SPD STD FAST**

Preset Value: LOGSWEEPSPD STD

Related Commands SWEPEYTYPE

Example

```
OUTPUT 718;"LOGSWEEPSPD FAST:"
```

Description

The LOGSWEEPSPD command sets the log sweep speed to fast or standard whenever the LOG frequency sweep type is active. LOGSWEEPSPD is only in effect when the instrument is operating in the log frequency sweep mode, as set by the SWEPEYTYPE command. It has no effect when a linear frequency sweep is active.

Setting LOGSWEEPSPD to “STD” optimizes the frequency accuracy of the sweep. Setting LOGSWEEPSPD to “FAST” minimizes the scan time of the sweep.

Changing LOGSWEEPSPD has an effect on the minimum sweep time set by the SWEPEYTIME command. When LOGSWEEPSPD is set to “FAST”, the minimum sweep time is less than or equal to the minimum sweep time when LOGSWEEPSPD is set to “STD”.

Query Response

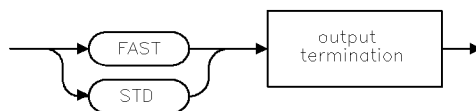

qloqswp

M4

Marker Zoom

Keeps the marker at center frequency.

Syntax

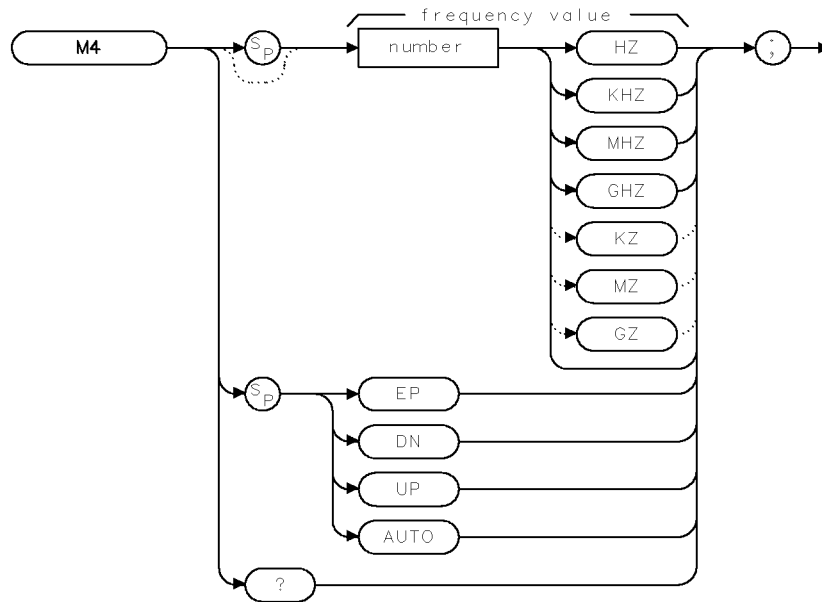

XM4

Item	Description/Default	Range
Number	Any real or integer number.	Start frequency to stop frequency of instrument.

Step Decrement: Span divided by 2
 Step Increment: Span multiplied by 2
 Related Commands: MKCF, MKN, SP

Example

OUTPUT 718;"M4;"

Description

The M4 command activates a single marker on the trace and enables the knob to change the position of the marker. When changing the frequency span, M4 keeps the marker at center frequency. Used with a marker on the signal peak or at a position of interest, M4 keeps the marker at center screen while the frequency span is decreased.

Query Response

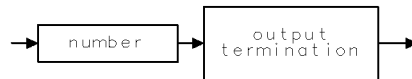

001

MDS

Measurement Data Size

Specifies measurement data size as byte or word.

Syntax

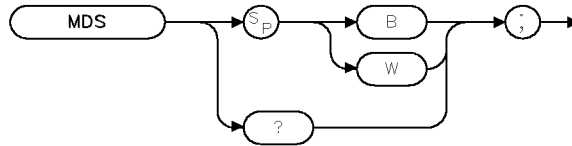

XMDS

Related Commands: MKA, TDF, TRA

Preset State: W

Example

These commands transfer trace A in binary, 2 bytes per word.

INTEGER TRACE_A (1:401)	<i>Declares variable, Trace_A.</i>
OUTPUT 718;"SNGLS;TS;"	<i>Activates single-sweep, updates trace A.</i>
OUTPUT 718;"TDF B;MDS W;TRA?;"	<i>Reads trace A in "word" format.</i>
ENTER 718 USING "#,401(W)";TRACE_A(*)	<i>Formats trace A output using data size of one word.</i>
PRINT TRACE_A(*)	<i>Prints trace A.</i>

Description

The MDS command formats binary data in one of the following formats:

B selects a data size of one 8-bit byte. When transferring trace data, MDS B transfers trace data faster than MDS W because only 401 bytes are transferred. Because MDS B combines two bytes into one byte, some resolution is lost.

W selects a data size of one word, which is two 8-bit bytes. When transferring trace data, MDS W transfers 802 bytes of trace data with no loss of resolution.

How data is represented with MDS W: When data is sent with MDS W, the trace data is converted into two bytes as follows:

1. The trace element's amplitude (in measurement units) is divided by 256. The binary representation of the result is placed in the most significant byte (MSB).
2. The binary representation of the remainder is placed in the least significant byte (LSB).

For example, a trace element that is at the reference level has the value of 8000 (in measurement units). The result of 8000 divided by 256 is 30, with a remainder of 120. For this data, the contents of the MSB would contain the binary representation for 30.

Contents of the MSB

0	0	0	1	1	1	1	0
---	---	---	---	---	---	---	---

MDS Measurement Data Size

For this data, the contents of the LSB would contain the binary representation for 120.

Contents of the LSB

0	1	1	1	0	0	1	0
---	---	---	---	---	---	---	---

How data is represented with MDS B: When data is sent with MDS B, the trace data is converted into one byte as follows:

- The trace element's amplitude (in measurement units) is divided by 32. The binary representation of the result is placed into one byte.

For example, a trace element that is at the reference level has the value of 8000 (in measurement units). The result of 8000 divided by 32 is 250. For this data, the contents of the byte would contain the binary representation for 250.

Contents of Byte

1	1	1	1	1	0	1	0
---	---	---	---	---	---	---	---

See "TDF" for information about using MDS for trace data transfers.

Query Response:

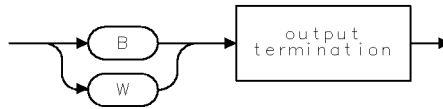

QMDS

MDU

Measurement Data Units

Returns values for the instrument baseline and reference level.

Syntax

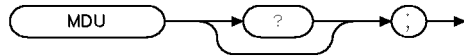

XMDU

Related Commands: TDF

Example

```
10 OUTPUT 718;"IP;TDF M;" Initializes the instrument and formats the trace data in measurement units.
20 OUTPUT 718;"RL 80DB;" Changes the reference level to 80 dBμV.
30 OUTPUT 718;"MDU?;" Queries the position of the instrument baseline and reference level.
40 ENTER 718;A,B,C,D,A$ Moves the instrument response to the computer.
50 PRINT A,B,C,D,A$ Displays the results on the computer screen.
60 END
```

The example returns the following to the controller: 0, 200, 0, 80 dB μ V. The first two numbers received indicate that the vertical scale spans from 0 to 200 plotter units. The third and fourth number received indicate that the baseline is at 0 dB μ V, and the reference level is at 80 dB μ V. So, the baseline value of 0 dB μ V is equal to 0 plotter units. The reference level of 80 dB μ V is equal to 200 plotter units.

Description

The MDU command returns values for the instrument baseline and reference level, in plotter units and measurement units.

Query Response

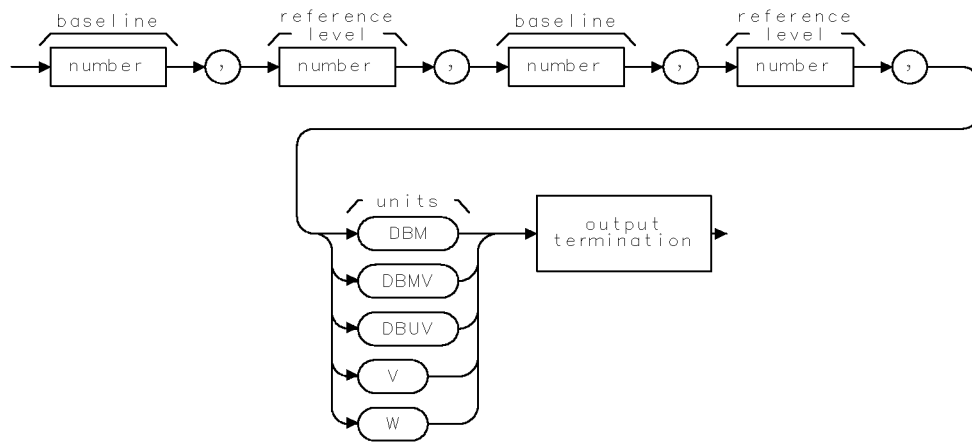

QMDU

MEAN

Trace Mean

Returns the mean value of the given trace in measurement units.

Syntax

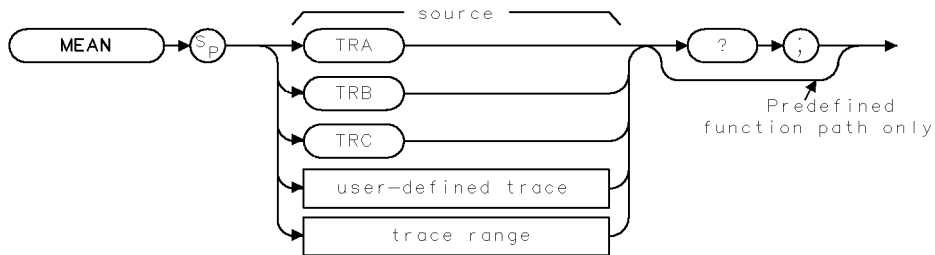

XMEAN

Item	Description/Default	Range
User-defined trace	A trace defined by the TRDEF command	Any valid trace name.
Trace Range	A segment of trace A, trace B, trace C, or a user-defined trace.	

Prerequisite Commands: TRDEF when using a user-defined trace. TS when using trace data.

Related Commands: MEANTH, RMS, VARIANCE

Example

```

10 OUTPUT 718;"IP;"           Initializes instrument.
20 OUTPUT 718;"SNGLS;"       Activates the single-sweep mode.
30 OUTPUT 718;"CF 300MHZ;SP 1MHZ;" Sets measurement range.
40 OUTPUT 718;"TS;"         Sweeps trace A.
50 OUTPUT 718;"MEAN TRA?;"   Returns the mean value of trace A to the computer.
60 ENTER 718;Number          Assigns value to computer variable, Number.
70 DISP "MEAN OF TRACE A IS ";Number Displays result on the computer screen.
80 END

```

Description

The MEAN command returns the mean value of the given trace in measurement units.

Query Response

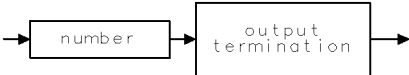

001

MEANTH

Trace Mean Above Threshold

Returns the mean value of the given trace above the threshold, in measurement units.

Syntax

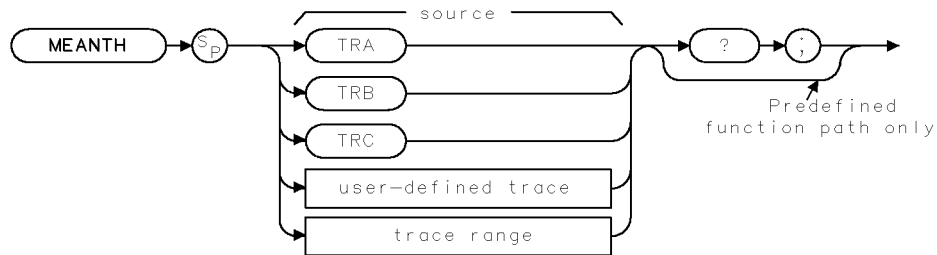

XMEANTH .

Item	Description/Default	Range
User-defined trace	A trace defined by the TRDEF command	Any valid trace name.
Trace Range	A segment of trace A, trace B, trace C, or a user-defined trace.	

Prerequisite Commands: TRDEF when using a user-defined trace. TS when using trace data.

Related Commands: MEAN, RMS, TH, VARIANCE

Example

10 OUTPUT 718;"IP;"	<i>Initializes instrument.</i>
20 OUTPUT 718;"SNGLS;"	<i>Activates the single-sweep mode.</i>
30 OUTPUT 718;"CF 300MHZ;SP 1GHZ;"	<i>Sets measurement range.</i>
40 OUTPUT 718;"TH 45;"	<i>Sets threshold level to 45 dBμV.</i>
50 OUTPUT 718;"TS;"	<i>Sweeps trace A.</i>
60 OUTPUT 718;"MEANTH TRA?;"	<i>Returns the mean value of trace A above the threshold to the computer.</i>
70 ENTER 718;Number	<i>Assigns value to computer variable, Number.</i>
80 DISP "MEAN OF TRACE A ABOVE THE THRESHOLD IS ";Number	<i>Displays result on the computer screen.</i>
90 END	

MEANTH Trace Mean Above Threshold

Description

MEANTH returns the mean value of the trace above the threshold; MEAN returns the mean value of the trace, regardless of the threshold level. MEANTH returns a “0” if there is not a signal above the threshold.

Use TH (threshold) to set the threshold level.

Query Response

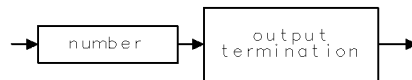

001

MEASALLSIGS

Measure All Signals

Finds all signals on the display, or all signals above a margin on the display, then makes an EMI measurement.

Syntax



xmallsig .

Equivalent Softkey: **AUTO-MEASURE**

Related Commands: AUTOAV, AUTOQPD, LIMIMARGAMP, LIMIMARGSTA, MEASSIG, MEASTIMEAVG, MEASTIMEPK, MEASTIMEQPD, REMEASSIG, SIGDEL, SIGLIST

Example

```
OUTPUT 718; "MEASALLSIGS;"
```

Description

The MEASALLSIGS command finds all signals on the display and makes an EMI measurement using specified detectors. Each signal is tuned to in sequence, the span is reduced in steps to zero span, and a maximum of three detectors are measured. The detectors used are chosen using AUTOAVG, and AUTOQPD commands. Measurement time is determined by MEASTIMEPK, MEASTIMEQPD, and MEASTIMEAVG commands. After each signal is measured it is added to the signal list.

When a limit margin is turned on, only those signals whose initial amplitude are above a margin are measured. If both margin 1 and margin 2 are on, the signal is compared to the lowest amplitude margin at that frequency.

MEASAVG Measure Average

Makes a measurement with the peak and average detectors.

Syntax

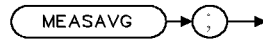

xmeasav . . .

Related Commands: MEASPEAK, MEASQPD, MEASSIG, MEASTIMEAVG, MEASURE

Example

```
DIM A$ [140]
OUTPUT 718;"MEASAVG;"
OUTPUT 718;"MEASRESULT?"
ENTER 718; A$
```

Description

The MEASAVG command makes a measurement with the peak and average detectors, using the marker position as the measurement frequency. It spans down on the signal located at the marker, then in zero span, measures the average detector using the measurement time set by the MEASTIMEAVG command. The result of the measurement can be obtained using the MEASRESULT command.

MEASFREQ

Measure Frequency

Makes a measurement at the specified frequency.

Syntax

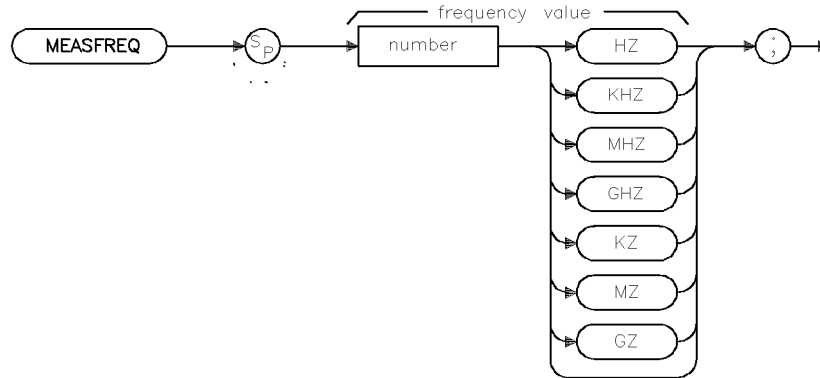

xmeafre

Related Commands: AUTOAVG, AUTOQPD, MEASTIMEAVG, MEASTIMEPK, MEASTIMEQPD, MEASRESULT

Example

```
DIM A$ [140]
OUTPUT 718;"MEASFREQ 300MZ;"
OUTPUT 718;"MEASRESULT?"
ENTER 718; A$
```

Description

The MEASFREQ command makes a measurement by tuning directly to the specified frequency in zero span. Then, it measures the detectors specified by AUTOQPD and AUTOAVG commands. Measurement time is determined by MEASTIMEPK, MEASTIMEQPD, AND MEASTIMEAVG commands. The result of the measurement can be obtained by using the MEASRESULT command.

MEASPEAK Measure Peak

Makes a measurement using the peak detector.

Syntax

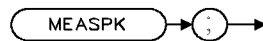

xmeaspk .

Related Commands: MEASAVG, MEASQPD, MEASSIG, MEASTIMEPK, MEASRESULT

Example

```
DIM A$ [140]
OUTPUT 718;"MEASPEAK;"
OUTPUT 718;"MEASRESULT?"
ENTER 718; A$
```

Description

The MEASPEAK command makes a measurement using the peak detector with the marker position as the measurement frequency. First, it spans down on the signal located at the marker, then in zero span, measures the peak detector using the measurement time set by the MEASTIMEPK command. The result of the measurement can be obtained by using the MEASRESULT command.

MEASQPD

Measure Quasi-Peak Detector

Makes a measurement using the quasi-peak and peak detectors.

Syntax

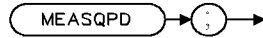

xmeasqpd .

Related Commands: MEASAVG, MEASPEAK, MEASRESULT, MEASSIG, MEASTIMEQPD

Example

```
DIM A$ [140]
OUTPUT 718;"MEASQPD;"
OUTPUT 718;"MEASRESULT?"
ENTER 718; A$
```

Description

The MEASQPD command makes a measurement with the peak and quasi-peak detector using the marker position as the measurement frequency. First, it spans down on the signal located at the marker, then in zero span, measures the quasi-peak detector using the measurement time set by the MEASTIMEQPD command. The result of the measurement can be obtained by using the MEASRESULT command.

MEASRESULT Measure Result

Sends the results of the last EMI measurement to the controller.

Syntax

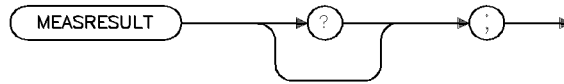

xmeares

Related Commands: MEASAVG, MEASPEAK, MEASQPD, MEASSIG, REMEASSIG

Example

```

10 DIM Result$ [140]
20 OUTPUT 718; "CF 300MZ;"
30 OUTPUT 718; "SP 10MZ;"
40 OUTPUT 718; "MKPK HIGH;"
50 OUTPUT 718; "MEASSIG;"
60 OUTPUT 718; "MEASRESULT;"
70 ENTER Result$
80 PRINT Result$

```

Description

The MEASRESULT command sends the results of the last EMI measurement to the controller. The measurements are performed using MEASSIG, REMEASSIG, MEASPEAK, MEASQPD, or MEASAVG commands and their corresponding front-panel keys (if any). If no measurement has been performed, an ASCII NULL with EOI asserted is sent.

Query Response

MEASRESULT Measure Result

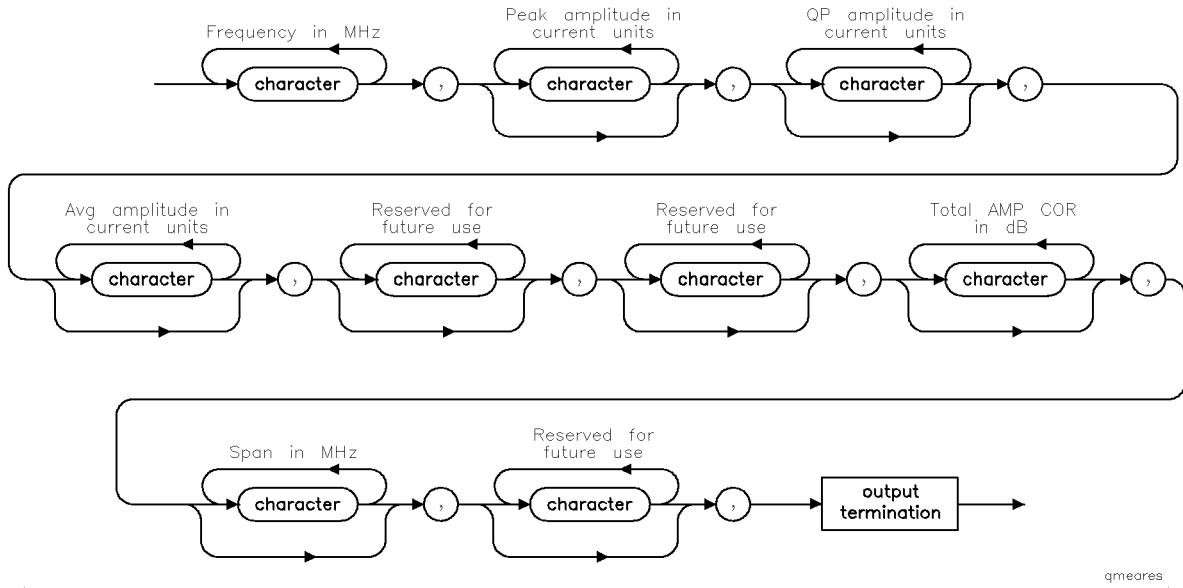

MEASSIG Measure Signal

Makes a measurement using specified detectors.

Syntax

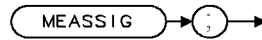

xmeasig .

Equivalent Softkey: **MEASURE AT MKR**

Related Commands: AUTOAVG, AUTOQPD, MEASALLSIGS, REMEASSIG, SIGDEL, SIGLIST, SIGMARK, SIGUNMARK

Example

```

DIM A$ [140]
OUTPUT 718;"MEASSIG;"
OUTPUT 718;"MEASRESULT?"
ENTER 718; A$
  
```

Description

The MEASSIG command makes a measurement using specified detectors with the marker position as the measurement frequency. The detectors used are chosen from the AUTOAVG and AUTOQPD commands. The result of the measurement can be obtained by using the MEASRESULT command.

Note When the selected bandwidth is a non-CISPR bandwidth the message, Non-CISPR bandwidth being used, press CONTINUE to resume or press USE CISPR to change, is displayed.

MEASTIMEAVG

Measure Time Average

Sets the average detector measurement time.

Syntax

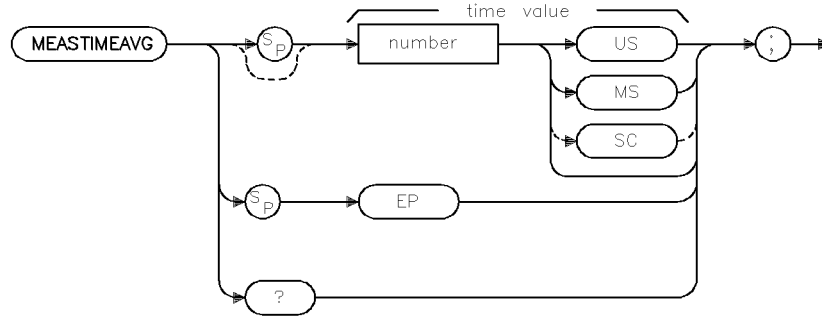

xmstmav

Item	Description/Default	Range
Number	Any real or integer.	20 mS to 65.535 S

Equivalent Softkey: **AV DWELL TIME**

Preset State: 200 mS

Related Commands: AUTOAVG, AUTOQPD, MEASALLSIGS, MEASTIMEQPD, MEASTIMEPK, REMEASSIG

Example

OUTPUT 718; "MEASTIMEAVG 500MS;"

Description

The MEASTIMEAVG command sets the measurement time when the average detector is measured in conjunction with MEASAVG, MEASSIG, MEASFREQ, MEASALLSIGS, and REMEASSIG commands.

Query Response

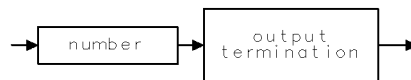

001

MEASTIMEPK

Measure Time Peak

Sets the peak detector measurement time.

Syntax

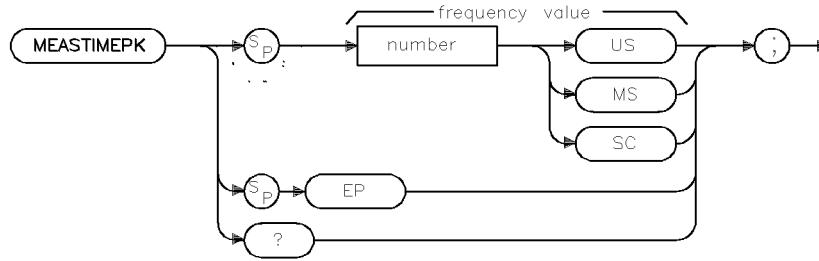

xmstmpk

Item	Description/Default	Range
Number	Any real or integer.	20 mS to 65.535 S

- Equivalent Softkey: **PK DWELL TIME**
- Preset State: 200 mS
- Related Commands: AUTO AVG, AUTOQPD, MEASFREQ, MEASTIMEAVG, MEASTIMEQPD

Example

OUTPUT 718; "MEASTIMEPK 500MS;"

Description

The MEASTIMEPK command sets the measurement time when the peak detector is measured in conjunction with MEASPEAK, MEASSIG, MEASFREQ, MEASALLSIGS, and REMEASSIG commands.

Query Response

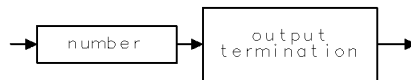

Q01

MEASTIMEQPD

Measure Time Quasi-Peak Detector

Sets the quasi-peak detector measurement time.

Syntax

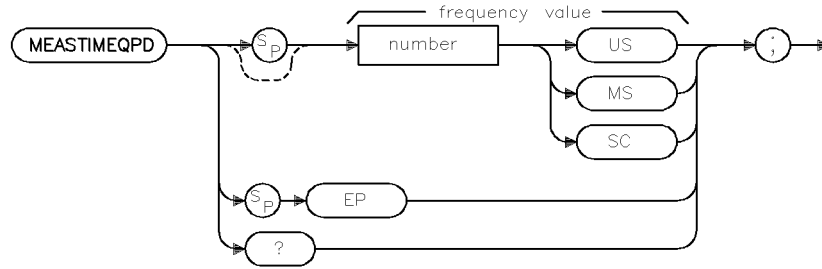

xmstqpd

Item	Description/Default	Range
Number	Any real or integer.	20 mS to 65.535 S

Equivalent Softkey: **QP DWELL TIME**

Preset State: 200 mS

Related Commands: AUTOAVG, AUTOQPD, MEASALLSIGS, MEASFREQ, MEASTIMEAVG, MEASTIMEPK, REMEASSIG

Example

```
10 OUTPUT 718; "MEASTIMEQPD 500MS;"
```

Description

The MEASTIMEQPD command sets the measurement time when the quasi-peak detector is measured in conjunction with MEASQPD, MEASSIG, MEASFREQ, MEASALLSIGS, and REMEASSIG commands.

Query Response

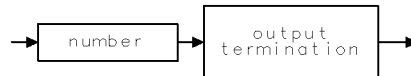

001

MEASURE

Measure Mode

Determines what kind of measurements the instrument makes.

Syntax

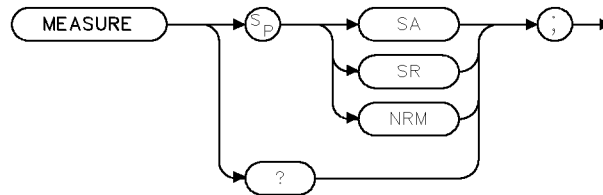

XMEASURE

Equivalent Softkey: SWP CPLG SR RECV

Related Commands: AUNITS, DL, INZ, LN, MKA, MKREAD, MKRL, RL, RLPOS, ROFFSET, TH

Preset State: MEASURE SA

Example

Activate the tracking-generator source output.

```

OUTPUT 718;"MEASURE SR;"      Sets instrument to stimulus-response mode.
OUTPUT 718;"SRCPWR 80DB;"     Makes the tracking generator source power the active
                               function.
  
```

Description

The MEASURE command determines what kind of measurements the instrument makes: signal analysis, stimulus response, or signal normalization.

“MEASURE SA;” activates receiver mode and auto couples the instrument functions. If AMB ON or AMBPL ON and RLPOS have been executed prior to MEASURE SA, MEASURE SA turns off the reference level position. When normalization is off, all amplitude units are specified in absolute values determined by:

- Amplitude units (AUNITS)
- Reference level (RL)
- Reference-level offset (ROFFSET)
- Input impedance (INZ)
- Logarithm scale (LG)
- Linear scale (LN)
- Amplitude Correction (AMPCOR)

“MEASURE SR;” activates stimulus-response measurements and uncouples the sweep time for faster sweep times. If AMB ON or AMBPL ON and RLPOS are executed, MEASURE SR activates the reference level position. When normalization is used, amplitude units are specified relative to the display level.

MEASURE Measure Mode

During this relative-amplitude mode, the following parameters are in dB:

- Trace data (TRA, TRB, TRC)
- Display line (DL)
- Threshold (TH)
- Marker amplitude (MKA)

“MEASURE NRM;” recouples the sweep time for accurate signal analysis measurements. If AMB ON or AMBPL ON and RLPOS are executed, MEASURE NRM activates the reference level position.

See “RLPOS” for more information about changing the reference level position.

When used as a predefined variable, MEASURE returns a value depending on the setting of the MEASURE parameter.

MEASURE Parameter	Value Returned
SA	0
SR	1
NRM	2

Query Response

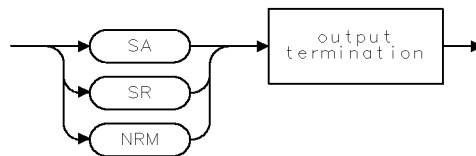

QMEASURE .

MEASWITHPP Measure With Preselector Peak

For an HP 8546A/HP 85462A only.

Peaks the preselector before making an EMI measurement.

Syntax

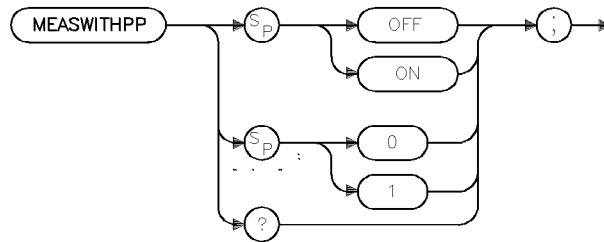

xmwpp

Preset State: MEASWITHPP ON

Related Commands: PP, MEASPEAK, MEASAVG, MEASQPD, MEASFREQ, MEASALLSIGS, MEASSIG, REMEASSIG

Example

```
OUTPUT 718; "MEASWITHPP OFF;"
```

Description

The MEASWITHPP command automatically peaks the preselector, for signals above 2.75 GHz, prior to making an EMI measurement. The EMI measurements affected are: Measure At Marker, Stepped Measurements, Signal List Remeasure, and Auto Measure. With MEASWITHPP ON, a Preselector Peak (PP) is done prior to measuring with any of the three detectors. With MEASWITHPP OFF, no preselector peak is done.

Query Response

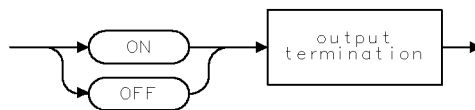

002

MERGE

Merge Two Traces

Merges the source trace into the specified area of the destination trace.

Syntax

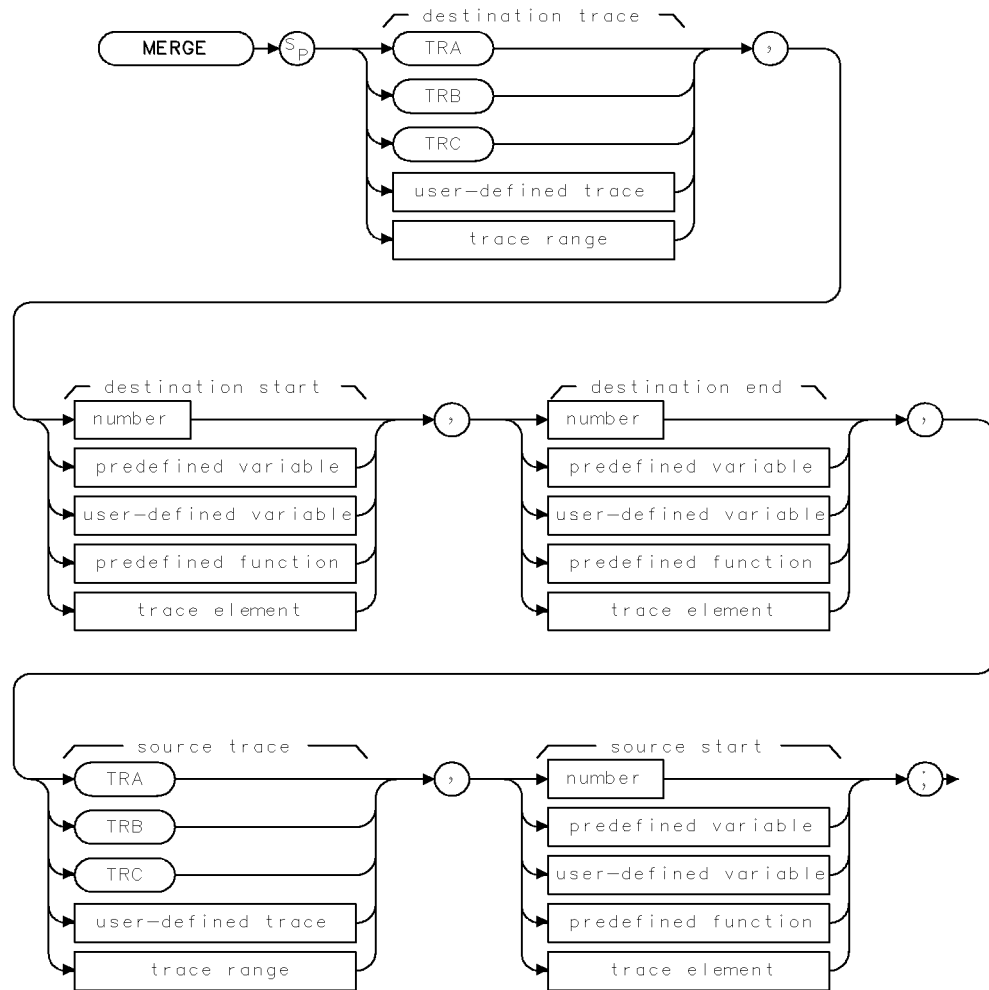

XMERGE

Item	Description/Default	Range
User-defined variable	A variable defined by VARDEF command.	Any valid variable name.
Predefined variable	A command that acts as a variable. Refer to Table 4-1.	
Predefined function	Function that returns a value. Refer to Table 4-1.	-32,768 to +32,767.
Trace element	An element of trace A, trace B, trace C, or a user-defined trace.	
Number	Any valid integer number.	

Related Commands: All other trace math commands. See Table 4-4 for a list of trace math commands.

Example

OUTPUT 718;"MERGE TRC,1,200,TRA,200;" *Merges trace A into trace C. The trace A elements 200 through 399 are merged into trace C elements 1 through 200.*

Description

The MERGE command copies the trace data from the source trace, starting at the specified trace element, into the specified trace elements of the destination trace. MERGE differs from CONCAT because MERGE does not need the trace range of the source to be specified. If the source is not a trace, its value is copied to the destination trace. If the destination segment is longer than the specified source segment, the last element of the source trace is repeated to fill the destination.

MF

Marker Frequency Output

Returns the frequency (or time) of the onscreen active marker.

Syntax

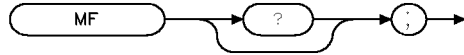

Related Commands: MA, MKA, MKCF, MKD, MKF, MKN, MKPK, MKREAD

Example

OUTPUT 718;"IP;SNGLS;CALSW INT;"	<i>Initializes the instrument, activates single-sweep mode.</i>
OUTPUT 718;"FA 280MHZ;FB 320MHZ;TS;"	<i>Sets up the measurement range.</i>
OUTPUT 718;"MKN;MKPK HI;"	<i>Places marker on peak of calibrator signal.</i>
OUTPUT 718;"MF;"	<i>Takes frequency of marker.</i>
ENTER 718;A	<i>Returns frequency to the computer.</i>
PRINT A	<i>Prints the frequency on the computer screen.</i>

Description

The MF command returns the frequency of the active marker to the controller if the marker is on screen. In delta marker mode, nonzero span, MF returns the frequency difference between the two markers. In zero span, "MF;" returns the marker time, or the delta marker time.

The data that is returned by MF depends on many command conditions including TDF, MKREAD, and MDS.

If the trace data format P is used with MF, the result is one real value in time units or frequency units, depending on the marker readout format. (See "MKREAD")

Example

OUTPUT 718;"TDF P;MKREAD FRQ;MF;"	<i>This returns a frequency value (in Hz) if not in zero-span.</i>
OUTPUT 718;"TDF P;MKREAD FRQ;MF;"	<i>This returns a time value (in seconds) if in zero-span.</i>
OUTPUT 718;"TDF P;MKREAD PER;MF;"	<i>This returns the time value (in seconds) of 1/(marker frequency).</i>
OUTPUT 718;"TDF P;MKREAD SWT;MF;"	<i>This returns the marker time value (in seconds).</i>
OUTPUT 718;"TDF P;MKREAD IST;MF;"	<i>This returns the frequency value (in Hz) for 1/(marker time).</i>
OUTPUT 718;"TDF P;MKREAD FFT;MF;"	<i>This returns the frequency value (in Hz).</i>

If the trace data format is used with trace data format A, the result depends on the setting of the MDS command.

MF Marker Frequency Output

Example

OUTPUT 718;"TDF A;MDS B;MF;" *Returns one byte representing the marker position. The byte can assume values 1 to 101.*

OUTPUT 718;"TDF A;MDS W;MF;" *Returns two bytes in a binary word format that has a value from 1 to 401.*

If the trace data format is used with trace data format M, the result is the marker horizontal position value, from 1 to 401, in ASCII.

Example

OUTPUT 718;"TDF M;MF;" *Returns marker horizontal position value in ASCII.*

Query Response

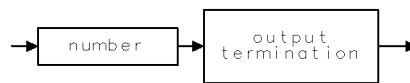

001

MIN

Minimum

Compares source 1 and 2, point by point, and stores the lesser of the two in the destination.

Syntax

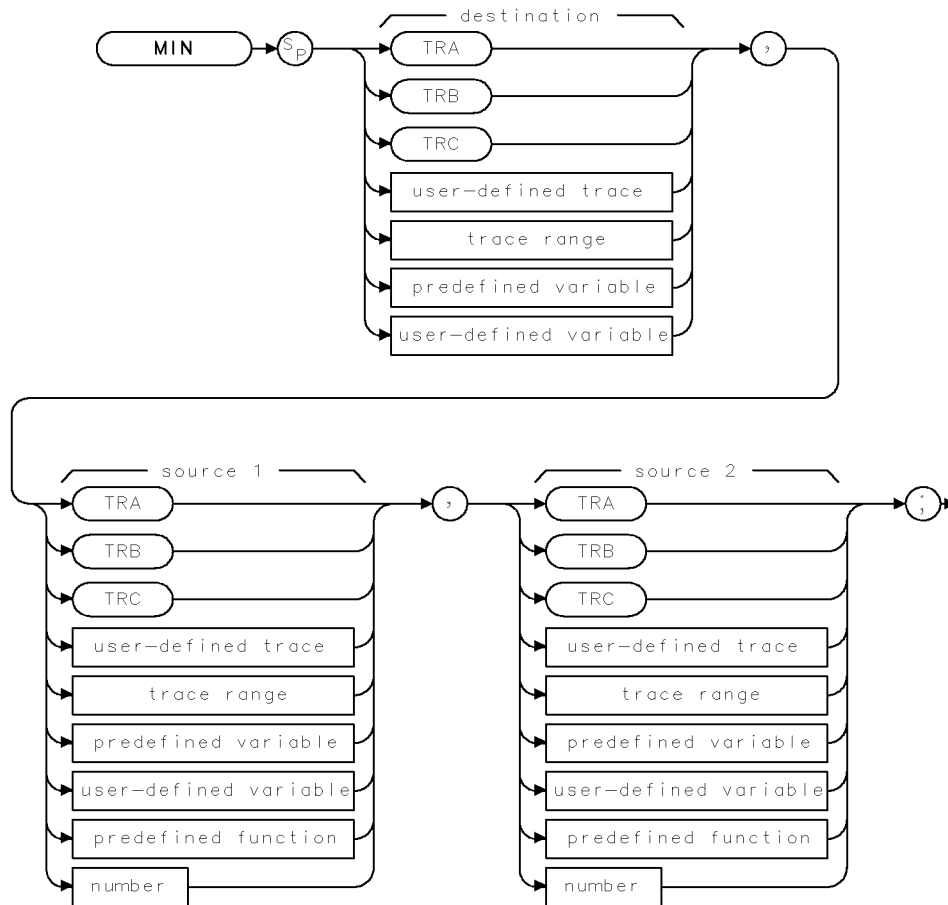

XMIN

Item	Description/Default	Range
User-defined trace	A trace defined by the TRDEF command.	Any valid trace name.
User-defined variable	A variable defined by VARDEF command.	Any valid variable name.
Predefined variable	A command that acts as a variable. Refer to Table 4-1.	
Predefined function	Function that returns a value. Refer to Table 4-1.	
Trace range	A segment of trace A, trace B, trace C, or a user-defined trace.	
Number	Any real or integer number.	Real number range.

Prerequisite Commands: TRDEF when using a user-defined trace. VARDEF when using a user-defined variable. TS when using trace data.

Related Commands: MINPOS, MXM, TS

Example

10 OUTPUT 718;"IP;"	<i>Initializes instrument.</i>
20 OUTPUT 718;"SNGLS;"	<i>Activates the single-sweep mode.</i>
30 OUTPUT 718;"VARDEF M_INIMUM,0;"	<i>Defines variable with an initial value of 0.</i>
40 OUTPUT 718;"TS;MKPK HI;"	<i>Sweeps trace A and places the marker at the highest peak.</i>
50 OUTPUT 718;"MIN M_INIMUM,MKA,50;"	<i>Compares the marker amplitude to 50 dBμV. Stores the lesser of the two in M_INIMUM.</i>
60 OUTPUT 718;"M_INIMUM?;"	<i>Returns the result to the computer.</i>
70 ENTER 718;Number	<i>Puts the result in the computer variable, Number.</i>
80 DISP Number	<i>Displays the result.</i>
90 END	

Description

The MIN command compares source 1 and 2, point by point, and stores the lesser of the two in the destination. If one of the sources is a single value, it acts as a threshold, and all values equal to or less than the threshold pass to the destination. The values larger than the threshold are replaced by the threshold value in the destination.

When the source is longer than the destination, the source is truncated to fit. When the source is shorter than the destination, the last element is repeated to fill the destination.

MINH

Minimum Hold

Updates trace C with the minimum level detected.

Syntax



XMINH

Equivalent Softkey: `MIN HOLD C`

Related Commands: BLANK, CLRW, MXMH, VAVG, VIEW

Example

OUTPUT 718;"CLRW TRC;CONTS;" *Clears trace C and begin taking data.*
OUTPUT 718;"MINH TRC;" *Updates trace C with the minimum level detected.*

Description

The MINH command updates trace C with a new value.

MINPOS

Minimum Position

Returns the x -axis position of the minimum amplitude value.

Syntax

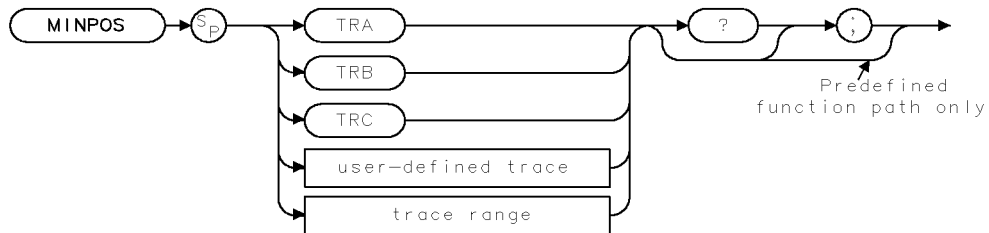

XMINPOS

Item	Description/Default	Range
User-defined trace	A trace defined by the TRDEF command.	Any valid trace name.
Trace range	A segment of trace A, trace B, trace C, or a user-defined trace.	

Prerequisite Commands: TRDEF when using a user-defined trace. TS when using trace data.

Related Commands: MIN, MKMIN, PKPOS

Example

```

10 OUTPUT 718;"IP;"           Initializes instrument.
20 OUTPUT 718;"MINPOS TRA;"   Finds the minimum value of trace A.
30 ENTER 718;Number          Returns value to the computer.
40 DISP Number               Displays result.
50 END

```

MINPOS Minimum Position

Description

The MINPOS command returns a value, which is the x -axis position (in display units) of the minimum amplitude value in trace A, trace B, trace C, or user-defined trace.

Using a trace range MINPOS returns a value relative to the first element of the trace range. For example, if a trace has a range of 150 to 300 elements, and the minimum value is element 200, MINPOS will return the value of 51.

Query Response

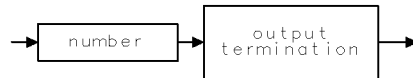

QQ1

MIRROR

Mirror Image

Stores the mirror image of the trace.

Syntax

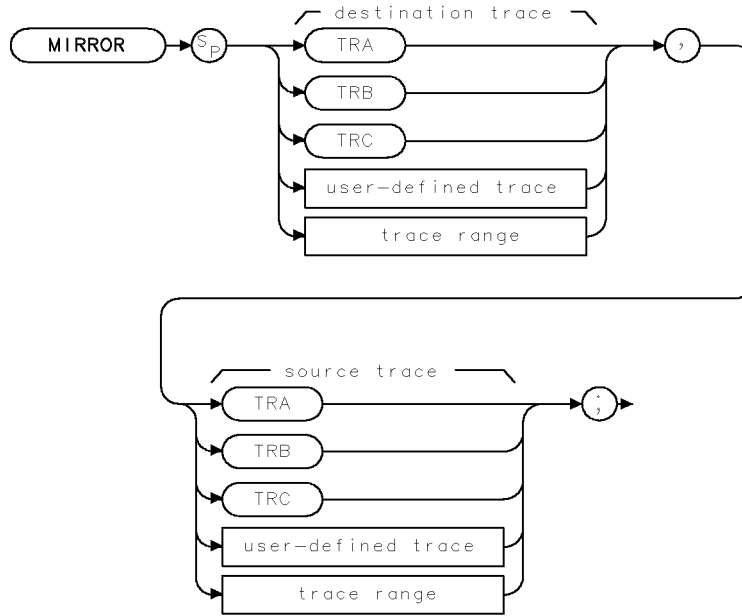

XMIRROR .

Item	Description/Default	Range
User-defined trace	A trace defined by the TRDEF command.	Any valid trace name.
Trace range	A segment of trace A, trace B, trace C, or a user-defined trace.	

Prerequisite Commands: TRDEF when using a user-defined trace. TS when using trace data.

Example

```

10 OUTPUT 718;"IP;"           Initializes instrument.
20 OUTPUT 718;"SNGLS;"       Activates the single-sweep mode.
30 OUTPUT 718;"TS;"         Takes sweep.
40 OUTPUT 718;"BLANK TRA;"   Blanks trace A from screen.
50 OUTPUT 718;"MIRROR TRB,TRA;" Moves the mirror image of trace A into trace B
60 OUTPUT 718;"VIEW TRB;"    Displays the result.
70 END

```

MIRROR Mirror Image

Description

The MIRROR command stores the mirror image (with respect to the frequency axis) of a source trace in a destination trace.

When the source is longer than the destination, the source is truncated to fit. When the source is shorter than the destination, the last element is repeated to fill the destination.

MKA Marker Amplitude

Specifies the amplitude of the active marker in the current amplitude units.

Syntax

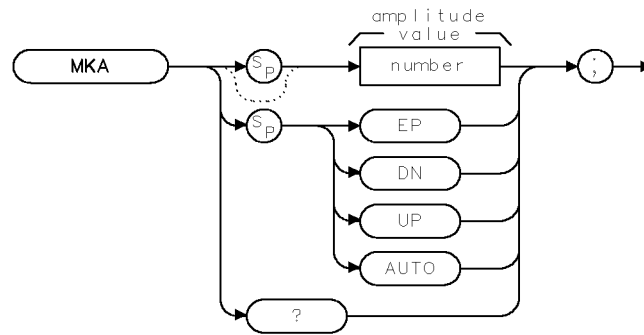

XMKA

Item	Description/Default	Range
Number	Any real or integer number. Unit is current amplitude type.	Amplitude range of instrument.

Equivalent Softkey: **MARKER AMPTD**

Step Increment: 1 dB

Related Commands: AUNITS, AUTO, MA, MKD, MKN, MKTYPE, TDF

Example

```
OUTPUT 718;"IP;"           Initializes the instrument.
OUTPUT 718;"MKTYPE AMP;"   Changes the marker type to amplitude.
OUTPUT 718;"MKA 50;"       Places the marker at 50 dBμV.
```

Description

The MKA command specifies the amplitude of the active marker in current units when the marker is the fixed or amplitude type (see "MKTYPE"). If both the delta marker and active marker are on the screen, "MKA?;" returns the amplitude difference between the two markers. Specifying the marker amplitude moves the marker to the point of the trace closest to the given marker amplitude.

If the trace data format P (TDF P), is used with MKA, the result is one real value in the current amplitude units (AUNITS can be used to change the current amplitude units).

MKA Marker Amplitude

Example

OUTPUT 718;"TDF P;AUNITS DBM;MKA?;" *This returns the amplitude value of the marker (amplitude unit is dBm).*

If the trace data format is used with trace data format A, the result depends on the setting of the MDS command.

Example

OUTPUT 718;"TDF A;MDS B;MKA?;" *Returns one byte representing the marker vertical position (–32,768 to 32,767) divided by 32 and then ANDed with 255.*

OUTPUT 718;"TDF A;MDS W;MKA?;" *Returns two bytes in a binary word format that has a value from –32,768 to 32,767. The value represents the binary trace amplitude value.*

Using the trace data format I is equivalent to the TDF A format. If the trace data format is used with trace data format M, the result is returned in ASCII measurement units (–32,768 to 32,767).

Example

OUTPUT 718;"TDF M;MKA?;" *Returns one vertical position value in measurement units.*

Query Response

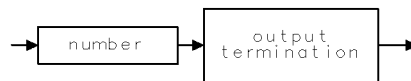

QQ1

MKACT Activate Marker

Specifies the active marker.

Syntax

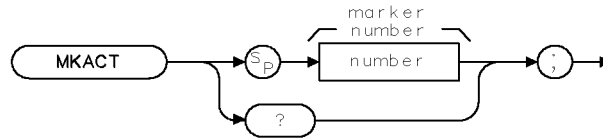

XMKACT

Item	Description/Default	Range
Number	Any valid integer. Default value is 1.	1 to 4.

Equivalent Softkey: `SELECT 1 2 3 4`

Related Commands: MA, MKA, MKF

Example

OUTPUT 718;"MKACT 4;" *Marker 4 becomes marker 1.*

Description

The MKACT command specifies the active marker.

There can be four different markers, but only one marker can be active at any time.

When this command is used, the following results occur:

The marker number supplied by the command is made marker 1, the active marker.

If the marker number is not already on, the marker is turned on with preset type (position), and the marker is placed at center screen. The trace chosen is the first displayed trace found: trace A, trace B, or trace C.

Note Using MKACT replaces marker 1 with the new marker function. The amplitude and frequency for the previous marker are not saved.

Query Response

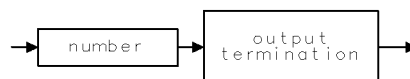

001

MKACTV

Marker As the Active Function

Makes the current active marker the active function.

Syntax

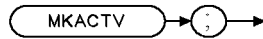

XMKACTV .

Equivalent Softkey: `MARKER <number> ON OFF`

Related Commands: MKACT, MKN, MKTYPE

Example

```
OUTPUT 718;"MKACT 2;"    Makes marker number 2 the active marker.
OUTPUT 718;"MKACTV;"    Makes marker number 2 the active function.
```

Description

The MKACTV command makes the current active marker the active function. If you have more than one marker displayed on the display, you need to make the desired marker the active function before you can manipulate the marker.

To make the marker the active function:

1. Select the desired marker with the MKACT command (MKACT makes the specified marker the active marker).
2. Execute MKACTV to make the active marker the active function.

If there is no active marker, executing MKACTV makes marker 1 the active marker and the active function. MKACTV makes the marker an active function according to its marker type (see "MKTYPE" for more information about marker type).

MKBW Marker Bandwidth

Returns the bandwidth at the specified power.

Syntax

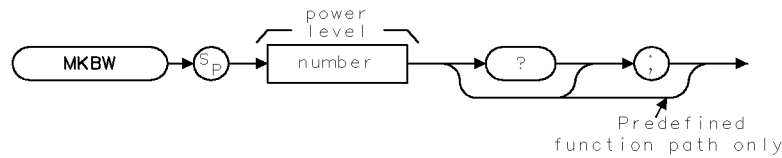

XMKBW

Item	Description/Default	Range
Number	Any valid negative integer.	0 to the amplitude of the noise floor.

Example

OUTPUT 718;"IP;"	<i>Initializes instrument.</i>
OUTPUT 718;"CF 300MHZ;SP 100MHZ;SNGLS;"	<i>Changes the center frequency and span, then activates the single-sweep mode.</i>
OUTPUT 718;"TS;MKPK HI;"	<i>Updates the sweep, places marker on signal peak.</i>
OUTPUT 718;"MKBW -3;"	<i>Uses the MKBW function to find the signal bandwidth at -3 dB below the marker.</i>

Description

The MKBW command returns the bandwidth at the specified power level relative to an onscreen marker (if present) or the signal peak (if no onscreen marker is present). It also displays (in the message area) the bandwidth at the power level in dB below the current marker position or the current signal peak.

MKBW finds the bandwidth at the specified power level for one measurement sweep.

MKCF

Marker to Center Frequency

Sets the center frequency equal to the marker frequency.

Syntax

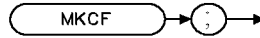

XMKCF

Equivalent Softkey: `MARKER -> CF`

Related Commands: `CF, MKF`

Example

This example provides a quick way to center the desired frequency on the screen.

```
10 OUTPUT 718;"IP;SP 1MHZ;SNGLS;" Initializes instrument, activates single-sweep mode.
20 INPUT "ENTER IN DESIRED STATION
    FREQUENCY, IN MHZ",Freq
30 OUTPUT 718;"CF ";Freq;"MHZ;" Changes instrument center frequency.
40 OUTPUT 718;"TS;MKPK HI;MKCF;TS;" Updates the trace, places marker at the signal peak and centers it on screen.
60 END
```

Description

The MKCF command sets the center frequency equal to the marker frequency and moves the marker to the center of the screen.

This command is performed only if an active marker is present on screen.

MKCONT Marker Continue

Resumes the sweep after execution of a MKSTOP command.

Syntax

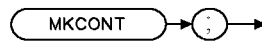

XMKCONT .

Related Commands: MKSTOP

Example

```
10 OUTPUT 718;"IP;TS;"      Initializes instrument.
20 OUTPUT 718;"MKPK HI;"    Creates an active marker.
30 OUTPUT 718;"MKSTOP;"    Stops sweep at marker.
40 OUTPUT 718;"MKCONT;"    Resumes sweep.
50 END
```

Description

The MKCONT command resumes the sweep after execution of a MKSTOP command.

MKD

Marker Delta

Activates the delta marker.

Syntax

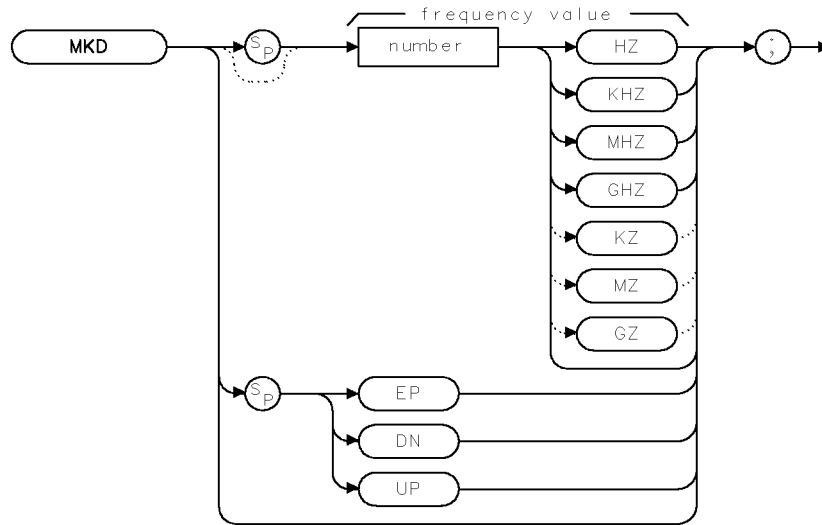

Item	Description/Default	Range
Number	Any real or integer number. Default unit is Hz, default value is value of the active marker.	Start frequency to stop frequency of instrument.

Equivalent Softkey: **MARKER Δ**

Step Increment: : by 1/10 of the frequency span

Related Commands: AUTO, MA, MKCF, MKF, MKN, MKSP, MKSS, MKPK

Example

```

10 OUTPUT 718;"IP;"           Initializes instrument.
20 OUTPUT 718;"MKMIN;"       Places a marker at the minimum amplitude of trace.
30 OUTPUT 718;"MKD;"         Activates marker delta.
40 OUTPUT 718;"MKPK HI;"     Places marker at highest amplitude of trace.
50 OUTPUT 718;"MKSP;"       Changes span to the values of the left and right markers.
60 END

```

Description

The MKD command computes the frequency and amplitude difference of the active marker and a special marker, called the delta or differential marker. These values are displayed in the display readout.

The differential value of the frequency is equal to the active marker frequency minus the delta marker frequency. The differential value of the amplitude is equal to the active marker amplitude minus the delta marker amplitude.

If an active marker is not on the screen, MKD positions an active marker at center screen. If a delta marker is not on the screen, MKD places one at the specified frequency, or at the current active marker. If the active marker is in amplitude mode, the delta marker is placed at the same amplitude as the active marker (or a specified value).

To read the amplitude, use MKA?. To read the frequency, use MKF?. The results are displayed on the screen.

In linear mode, MKD computes the ratio of the amplitudes of the active and delta markers rather than the difference. This results in similar treatment for logarithmic and linear data because the delta of the difference of two logarithmically generated numbers results in the logarithmically generated value of the ratio of the two numbers. (You should not change amplitude units when making a marker delta measurement, however.)

MKF

Marker Frequency

Specifies the frequency value of the active marker.

Syntax

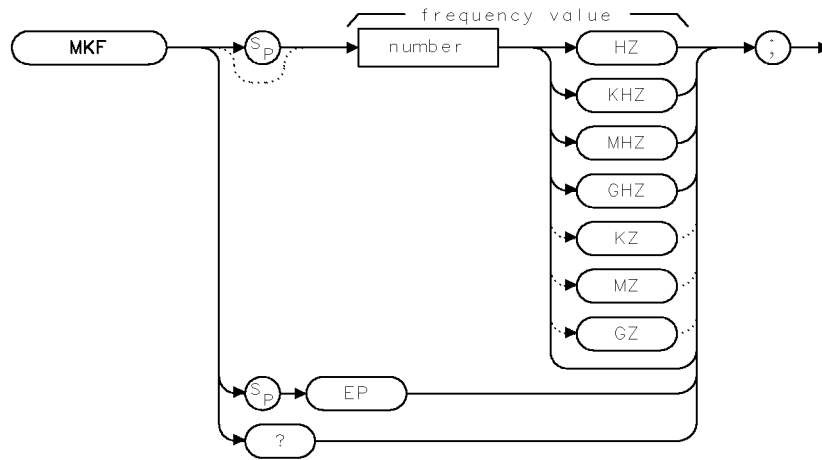

XMKF

Item	Description/Default	Range
Number	Any real or integer number. Default unit is Hz.	Start frequency to stop frequency of instrument.

Related Commands: AUTO, MKA, MKD, MKCF, MKPK

Example

OUTPUT 718;"MKF 600MHZ;" Places an active marker at 600 MHz.

Description

The MKF command specifies the frequency value of the active marker. In nonzero frequency spans, MKF returns the active marker frequency as a real number when MKF is queried. In zero span, "MKF?;" returns the time value.

The data that is returned by MKF depends on many command conditions, including TDF, MKREAD, and MDS.

MKF results with TDF set to P: If the trace data format P is used with MKF, the result is one real value in time units or frequency units, depending on MKREAD.

MKF Marker Frequency

Example

OUTPUT 718;"TDF P;MKREAD FRQ;MKF?;" *This returns a frequency value (in Hz) if not in zero-span.*

OUTPUT 718;"TDF P;MKREAD FRQ;MKF?;" *This returns a time value (in seconds) if in zero-span.*

OUTPUT 718;"TDF P;MKREAD PER;MKF?;" *This returns the time value (in seconds) of 1/(marker frequency).*

OUTPUT 718;"TDF P;MKREAD SWT;MKF?;" *This returns the marker time value (in seconds).*

OUTPUT 718;"TDF P;MKREAD IST;MKF?;" *This returns the frequency value (in Hz) for 1/(marker time).*

OUTPUT 718;"TDF P;MKREAD FFT;MKF?;" *This returns the frequency value (in Hz).*

MKF results with TDF set to A or I: If the trace data format is used with trace data format A, the result depends on the setting of the MDS command.

Example

OUTPUT 718;"TDF A;MDS B;MKF?;" *Returns one byte representing the marker position.*

OUTPUT 718;"TDF A;MDS W;MKF?;" *Returns two bytes in a binary word format that has a value from 1 to 401.*

Using the trace data format I is equivalent to the TDF A format.

MKF results with TDF set to M: If the trace data format is used with trace data format M, the result is the marker horizontal position value, from 1 to 401, in ASCII.

Example

OUTPUT 718;"TDF M;MKF?;" *Returns marker horizontal position value in ASCII.*

Query Response

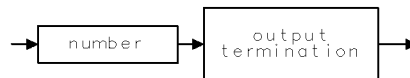

001

MKFC Marker Counter

Turns on or off the marker frequency counter.

Syntax

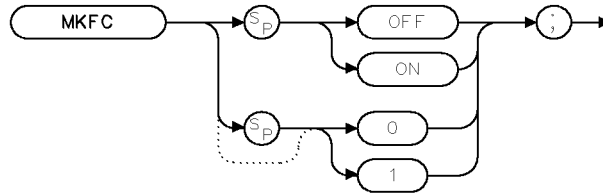

XMKFC

Equivalent Softkey: `MK COUNT ON OFF`

Related Commands: MKFCR, MKN.

Example

OUTPUT 718;"MKFC ON;" *Turns on the marker counter.*

Description

The MKFC command turns on or off the marker frequency counter.

MKFCR Marker Counter Resolution

Sets the resolution of the marker frequency counter.

Syntax

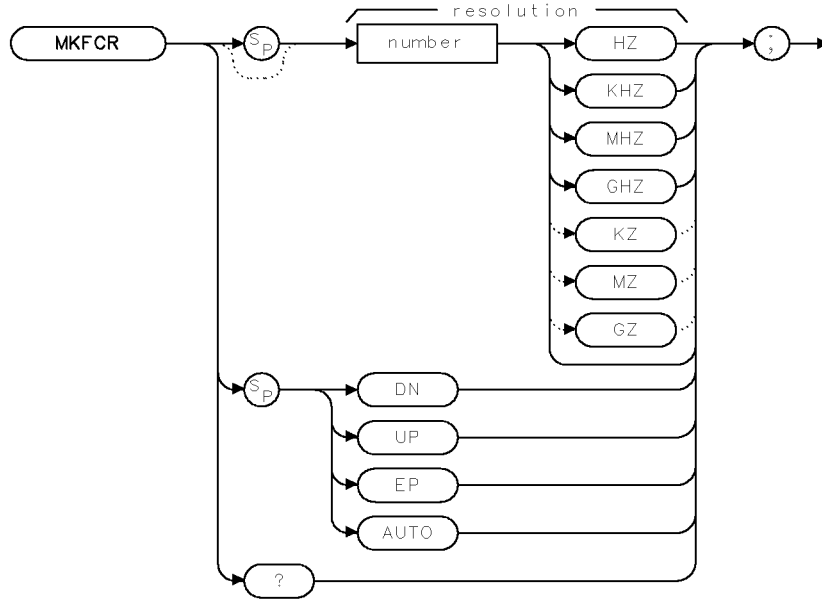

XMKFCR

Item	Description/Default	Range
Number	Any real or integer number. Default unit is Hz.	0 Hz to 100 kHz.

Equivalent Softkey: **CNT RES AUTO MAN**

Preset State: Marker counter resolution is set to AUTO. The calculated value for the marker counter resolution is returned if the MKFCR is queried.

Related Commands: AUTO, MKFC

Example

```

OUTPUT 718;"MKFCR 10KHZ;"  Sets the marker counter resolution to 10 kHz.
OUTPUT 718;"MKFCR?;"      Queries the marker counter resolution.
ENTER 718;A                Gets the query response.
DISP A                     Displays the marker counter resolution.
    
```

MKFCR Marker Counter Resolution

Description

The MKFCR command sets the resolution of the marker frequency counter. Executing either “MKFCR 0;” or “MKFCR AUTO;” auto-couples the marker counter resolution to the frequency span.

Query Response

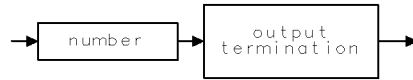

001

MKMIN Marker Minimum

Moves the active marker to the minimum value detected.

Syntax

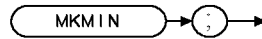

XMKMIN

Equivalent Softkey: **MARKER -> MINIMUM**

Related Commands: MKPK, SMOOTH, TH, VAVG

Example

```

10 OUTPUT 718;"IP;SNGLS;"
20 INPUT "ENTER IN THE START FREQUENCY,
   IN MHZ",Start_freq
30 INPUT "ENTER IN THE STOP FREQUENCY,
   IN MHZ",Stop_freq
40 OUTPUT 718;"FA ";Start_freq;"MHZ"
50 OUTPUT 718;"FB ";Stop_freq;"MHZ"
60 OUTPUT 718;"TS;MKPK HI;MKD;MKMIN;MKF?;"

70 ENTER 718;Delta_freq
80 PRINT "DIFFERENCE IN FREQUENCY IS ",
   Delta_freq,"HZ"
90 END

```

Initializes instrument, activates single-sweep mode.

Sets the start frequency.

Sets the stop frequency.

Updates trace, finds trace peak, turns on marker delta function, finds the minimum value of trace, and return the frequency delta.

Gets the result from instrument.

Description

The MKMIN command moves the active marker to the minimum value detected.

MKN

Marker Normal

Activates and moves the marker to the specified frequency.

Syntax

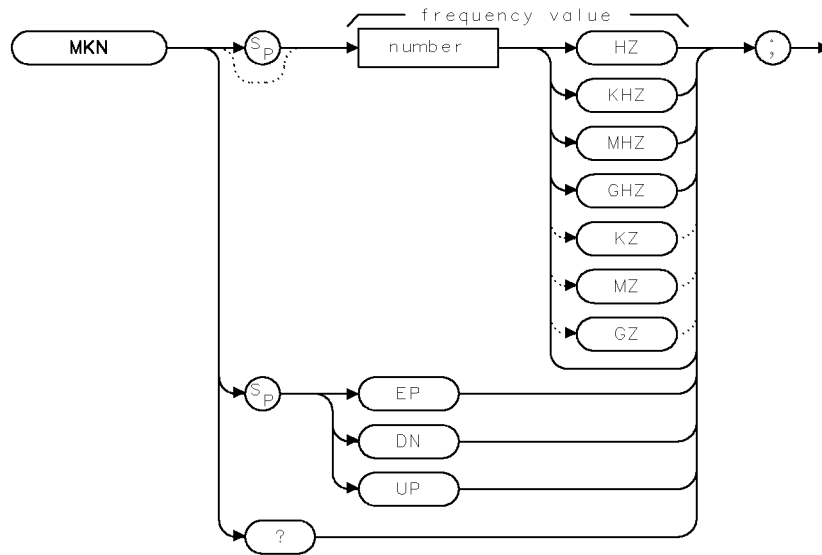

Item	Description/Default	Range
Number	Any real or integer number. Default unit is Hz. Default value is the center frequency of the instrument.	Start frequency to stop frequency of instrument.

Equivalent Softkey: **MARKER NORMAL**

Step Increment: by 1/10 of the frequency span when RCVRMRKR is off

Related Commands: AUTO, DEMOD, MKA, MKD, MKF, MKPK, RCVRMRKR

Example

```

10 INPUT "ENTER IN THE START FREQUENCY, IN MHZ",Start_freq
20 INPUT "ENTER IN THE STOP FREQUENCY, IN MHZ",Stop_freq
30 OUTPUT 718;"IP;FA ";Start_freq;"MHZ"

40 OUTPUT 718;"FB ";Stop_freq;"MHZ"
50 OUTPUT 718;"MKN EK;"

60 PRINT "PLACE MARKER ON THE DESIRED SIGNAL"
70 PRINT "PRESS HOLD THEN PRESS CONTINUE"
80 PAUSE

```

Initializes instrument and changes the start frequency. Changes the stop frequency. Enables the front-panel knob.

MKN Marker Normal

```
90 OUTPUT 718;"MKN?;"  
100 ENTER 718;Mkr  
  
110 PRINT "MARKER FREQUENCY IS ",Mkr,"Hz"  
120 END
```

Gets the frequency of the marker.

Puts the frequency value into the computer variable, Mkr:

Prints the result.

Description

The MKN command activates and moves the marker to the specified frequency. In nonzero span, "MKN?;" returns the frequency value. In zero span, "MKN?;" returns the time value.

Query Response

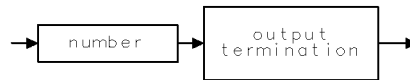

001

MKNOISE

Marker Noise

Displays the average noise level at the marker.

Syntax

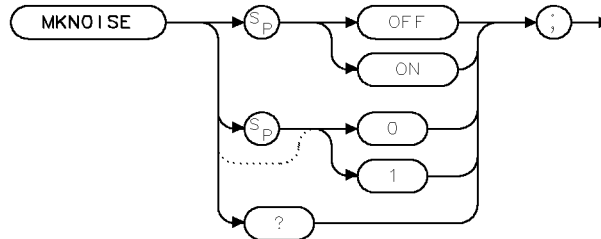

Equivalent Softkey: **MK NOISE ON OFF**

Related Commands: MKA, MKF, MKMIN, MKN

Example

```
OUTPUT 718;"IP;CF 300MHZ;SNGLS;"
```

Initializes instrument, changes center frequency, activates single-sweep mode.

```
OUTPUT 718;"SP 10MHZ;DET SMP;TS;"
```

Changes span, activates sample detector; updates trace.

```
OUTPUT 718;"MKPK HI;MKA?;"
```

Places marker on highest point of trace, queries marker amplitude.

```
ENTER 718;Amp_one
```

Puts the instrument response in the computer variable, Amp_one.

```
OUTPUT 718;"MKD UP;UP;MKNOISE ON;MKA?;"
```

Moves marker and turns on the marker noise function.

```
ENTER 718;Amp_two
```

Puts the instrument response in the computer variable, Amp_two.

```
OUTPUT 718;"MKNOISE OFF;"
```

Turns off the marker noise function.

```
DISP Amp_two
```

Displays the result.

```
C_to_n=Amp_one - Amp_two
```

Calculates the carrier to noise ratio.

```
PRINT "CARRIER TO NOISE RATIO IN 1 HZ
```

```
BANDWIDTH IS ";C_to_n
```

Outputs result.

```
PRINT " DB"
```

Description

The MKNOISE command displays the average noise level at the marker. The marker value is normalized to a 1-Hz bandwidth. Use “MKA?;” to read the noise marker value.

The noise marker averages 32 trace data values about the location of the marker on the frequency or time scale. The 32 values averaged, except for the first 15 or last 14 values in the trace, commence with the 16th point to the left of the marker, and end with the 15th point to the right of the marker. Note that the data values averaged are not exactly symmetrical with respect to marker position. At the trace end points, the instrument uses the nearest 32 data values. So while the marker may be moved to trace position 1 to 15, the actual amplitude value returned will be the same value for any marker position from 1 to 15. A similar situation applies for markers at the end of the trace.

A nominal correction for equivalent noise bandwidths is made by the firmware based on a nominal 3 dB resolution bandwidth. The firmware assumes the noise bandwidth is 1.12 times the resolution bandwidth. This means the shape of the resolution bandwidth filters cause the noise power to be overstated by 1.12 times. The detection mode also affects the measurement. If in log mode, the log detector understates the noise response. To compensate, 2.5 dB is added to the measurement. If the detector is in linear mode, the firmware uses 1.05 dB as a correction value.

In log detector mode, the final reported value will then be, with the result reported in dBm in a 1-Hz bandwidth:

$$(\text{Averaged value over 32 values}) - 10 \times (\log[1.12 \times \text{Resolution bandwidth}]) + 2.5 \text{ dB}$$

In linear detector mode (dBm) units, the final reported value will then be, with the result reported in dBm in a 1-Hz bandwidth:

$$(\text{Averaged value over 32 values}) - 10 \times (\log[1.12 \times \text{Resolution bandwidth}]) + 1.05 \text{ dB}$$

In linear detector mode with the normal display of voltage units, the noise marker voltage value will be related to the present marker voltage by this relation.

$$(V_{\text{noise_marker}})^2 = (V_{\text{average}})^2 \times 1.12 \times \text{Resolution bandwidth} \times 0.7824$$

$$V_{\text{noise_marker}} = V_{\text{average}} / (1.12 \times \text{Resolution bandwidth} \times 0.7824)^{0.5}$$

$$V_{\text{noise_marker}} = V_{\text{average}} \times 1.06633 / (\text{Resolution bandwidth})^{0.5}$$

Query Response

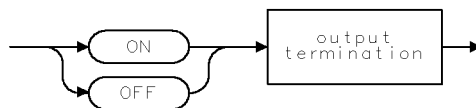

002

MKOFF

Marker Off

Turns off either the active marker or all the markers.

Syntax

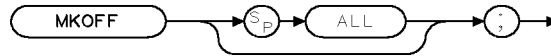

XMKOFF

Equivalent Softkey: **MARKER ALL OFF**

Related Commands: MKA, MKACTION, MKACTIONV, MKCF, MKD, MKF, MKN, MKPK

Example

OUTPUT 718;"MKOFF ALL;" *Turns off all the onscreen markers.*

Description

The MKOFF command turns off either the active marker or all the markers. If the ALL parameter is omitted, only the active marker is turned off.

MKP Marker Position

Places the active marker at the given *x*-coordinate.

Syntax

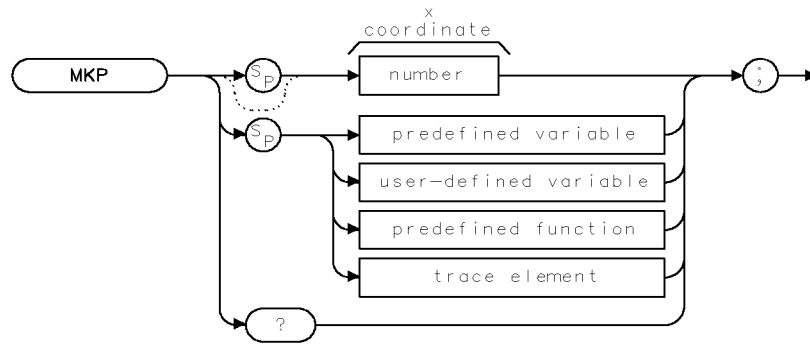

XMKP

Item	Description/Default	Range
Number	Any valid integer.	-401 to 401.
User-defined variable	A variable defined by VARDEF command.	Any valid variable name.
Predefined variable	A command that acts as a variable. Refer to Table 4-1.	
Predefined function	Function that returns a value. Refer to Table 4-1.	
Trace element	An element of trace A, trace B, trace C, or a user-defined trace.	

Prerequisite Commands: VARDEF when using a user-defined variable.

Related Commands: MKA, MKCF, MKD, MKMIN

Example

OUTPUT 718;"IP;" *Initializes instrument.*
 OUTPUT 718;"MKP 100;" *Moves the active marker to a element 100 of trace A.*

MKP Marker Position

Description

The MKP command places the active marker at the given x -coordinate. If no marker is active, the marker is turned on with preset type (position) and marker is placed at the given screen position. The marker is placed on the first displayed trace that is found (in order): trace A, trace B, or trace C.

If the marker delta mode is active, the value of the marker position is relative to the fixed marker, and therefore MKP can return a negative position.

Note that MKP and MKCF commands perform different functions. MKCF sets the center frequency equal to the marker frequency and moves the marker to the center of the screen. MKP places the marker to the position of the element specified.

Query Response

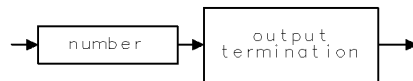

001

MKPAUSE Marker Pause

Pauses the sweep at the active marker.

Syntax

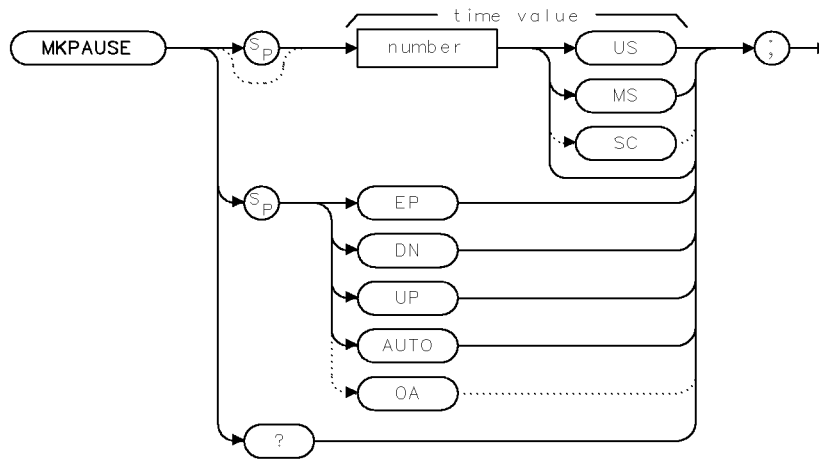

XMKPAUSE .

Item	Description/Default	Range
Number	Any real or integer number.	2 ms to 100 s.

- Equivalent Softkey: **MK PAUSE ON OFF**
- Step Decrement: Time value divided by 2
- Step Increment: Time value multiplied by 2
- Related Commands: DEMOD, MKA, MKF, MKFC, MKN, MKOFF, ST

Example

OUTPUT 718;"MKPAUSE 10SC;" *Changes the marker pause time to 10 seconds.*

MKPAUSE Marker Pause

Description

The MKPAUSE command pauses the sweep at the active marker for the duration of the delay period. To turn MKPAUSE off, turn off markers or send "MKPAUSE 0;".

The MKPAUSE command requires a sweep time of 50 ms or longer. The sweep time is changed to 50 ms if MKPAUSE is used with a sweep time that is less than 50 ms.

After MKPAUSE is executed, the sweep must be completed before another command will be executed.

Query Response

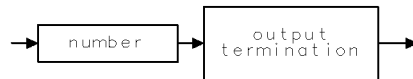

001

MKPK Marker Peak

Positions the active marker on a signal peak.

Syntax

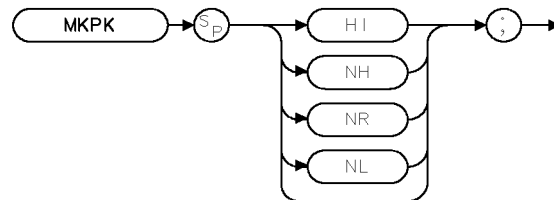

XMKPK

Equivalent Keys: `NEXT PEAK`, `NEXT PK RIGHT`, `NEXT PK LEFT`, and `PEAK SEARCH`

Related Commands: `MKCF`, `MKF`, `MKOFF`, `MKPX`, `TH`

Example

10 OUTPUT 718;"IP;"	<i>Initializes the instrument.</i>
20 OUTPUT 718;"SNGLS;TS;MKPK HI;"	<i>Places active marker on highest peak.</i>
30 OUTPUT 718;"MKA?;"	<i>Returns amplitude value of marker to the computer.</i>
40 ENTER 718;A	<i>Puts the instrument response in the computer variable, A.</i>
50 DISP A	<i>Displays amplitude value.</i>
60 END	

Description

The MKPK command positions the active marker on a signal peak. Executing MKPK HI, or simply MKPK, positions the active marker at the highest signal detected. If an active marker is on the screen, the MKPK parameters move the marker as follows:

HI (highest) moves the active marker to the highest peak.

NH (next highest) moves the active marker to the next signal peak of higher amplitude.

NR (next right) moves the active marker to the next signal right of the current marker.

NL (next left) moves the active marker to the next signal left of the current markerleft of the current marker. .

Note This function is for use with the frequency markers only.

MKPX

Marker Peak Excursion

Specifies the minimum signal excursion.

Syntax

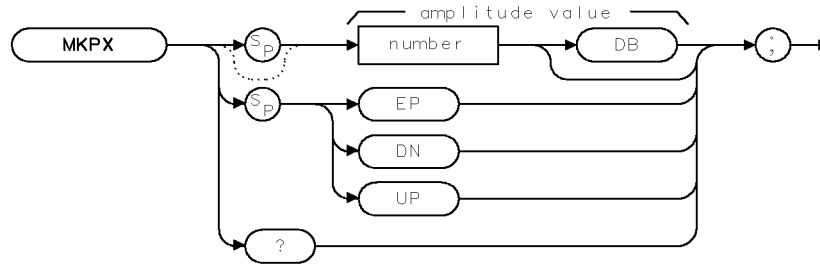

XMKPX

Item	Description/Default	Range
Number	Any real or integer number. Default unit is dB.	0 to 100 dB.

Equivalent Softkey: **PEAK EXCURSN**
 Preset State: 6 dB
 Step Increment: by 1 dB
 Related Commands: MKPK, PEAKS

Example

<pre> 10 OUTPUT 718;"IP;CF 300MHZ;SP 1GHZ;" 20 INPUT "ENTER IN PEAK EXCURSION, IN DB ",Excursion 30 OUTPUT 718;"MKPX ";Excursion;"DB;" 40 OUTPUT 718;"TS;MKPK HI;MKPK NH;" 50 OUTPUT 718;"MKF?;" 60 ENTER 718;Freq 70 IF Freq <> 0 THEN 80 PRINT "PEAK FOUND" 90 ELSE 100 PRINT "NO PEAKS FOUND" 110 END IF 120 END </pre>	<p><i>Initializes instrument, changes start and stop frequencies.</i></p> <p><i>Changes peak excursion level. Searches for highest peaks of trace.</i></p> <p><i>Finds frequency difference between peaks.</i></p> <p><i>Puts the instrument response in the computer variable, Freq.</i></p> <p><i>Outputs results if marker amplitude was not 0.</i></p> <p><i>Prints "NO PEAKS FOUND" if Freq = 0.</i></p>
--	---

Description

The MKPX command sets the minimum amplitude variation of signals that the marker can identify as a peak. If a value of 10 dB is selected, the marker moves only to peaks that rise and fall more than 10 dB above the threshold line (or the noise floor of the display). Pressing **PRESET** or turning on power resets the excursion to 6 dB, and the threshold to 70 dB below the reference level.

Note When a peak has a lump on its skirt that is the peak-excursion value above the threshold, the lump is considered a peak only if it has a peak excursion drop on both sides. Two peaks that are so close that only a valley divides them are not differentiated if the valley is not the peak-excursion value deep.

When the peak excursion value is less than 6 dB, the marker-peaking functions may not recognize signals less than 6 dB above the noise floor. To correct this, when measuring signals near the noise floor, the excursion value can be reduced even further. To prevent the marker from identifying noise as signals, reduce the noise floor variance to a value less than the peak-excursion value by reducing the average video bandwidth or by using video averaging.

Query Response

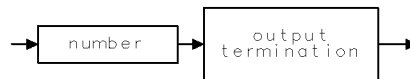

001

MKREAD

Marker Readout

Selects the type of active trace information displayed by the instrument's marker readout.

Syntax

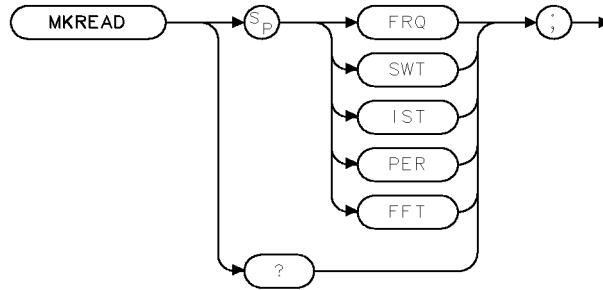

XMKREAD .

Equivalent Softkey: **MK READ F T I P** provides the marker readouts in the frequency, sweep time, inverse sweep time, and period. The fast Fourier transform readout is not available with the softkey, however.

Related Commands: FFT, MKF, MKTYPE

Example

```
OUTPUT 718;"MKREAD FFT;"
```

Description

The MKREAD command can select the following types of active trace information:

FRQ: frequency

SWT: sweep time

IST: inverse sweep time

PER: period

FFT: fast Fourier transform readout

The results of the data depend on the MKREAD parameter, the frequency span, and if the marker delta function is used.

MKREAD Marker Readout

MKREAD Type	Non-Zero Span	Non-Zero Span Delta	Zero Span	Zero Span Delta
FRQ	Reads frequency	Reads delta frequency	Reads time	Reads delta time
SWT	Reads time since the start of sweep	Reads delta time between end points	Waveform measurements of detected modulation	Waveform measurements of detected modulation
IST	N/A	N/A	N/A	Computes frequency corresponding to delta of markers. Performs $1/(T_1 - T_2)$
PER	Period of frequency	(Pulse measurement) delta time	N/A	N/A
FFT	N/A	N/A	Reads frequency corresponding the to FFT bucket	Reads delta frequency corresponding to delta FFT bucket

Query Response

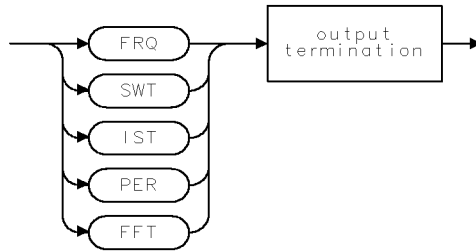

QMKREAD .

MKRL

Marker to Reference Level

Sets the reference level to the amplitude value of the active marker.

Syntax

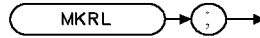

XMKRL

Equivalent Softkey: `MARKER -> REF LVL`

Related Commands: MKOFF, RL

Example

```
10 OUTPUT 718;"IP;SNGLS;CF 300MHZ;SP 20MHZ;"
```

Initializes instrument, changes center frequency and span.

```
20 OUTPUT 718;"TS;MKPK HI;MKRL;TS;"
```

Places a marker on trace peak, sets the reference level to the amplitude of the active marker; updates the sweep.

```
30 OUTPUT 718;"RL?;"
```

Gets the reference level.

```
40 ENTER 718 USING "K";Ref_level
```

Puts the instrument response in the computer variable, Ref_level.

```
50 OUTPUT 718;"AUNITS?;"
```

Gets the current amplitude units.

```
60 ENTER 718;Aunits$
```

```
50 PRINT "REFERENCE LEVEL IS",Ref_level,Aunits$
```

```
60 END
```

Description

The MKRL command sets the reference level to the amplitude value of the active marker.

MKSP Marker to Span

Sets the start and stop frequencies to the values of the delta markers.

Syntax

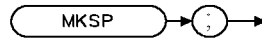

XMKSP

Equivalent Softkey: MKR Δ SPAN

Related Commands: MKD, SP

Example

10 OUTPUT 718;"IP;"	<i>Initializes instrument.</i>
20 OUTPUT 718;"MKMIN;"	<i>Places a marker at the minimum amplitude of trace.</i>
30 OUTPUT 718;"MKD;"	<i>Activates marker delta.</i>
40 OUTPUT 718;"MKPK HI;"	<i>Places marker at highest amplitude of trace.</i>
50 OUTPUT 718;"MKSP;"	<i>Changes span to the values of the left and right markers.</i>
60 END	

Description

The MKSP command sets the start and stop frequencies to the values of the delta markers. The left marker specifies start frequency, and the right marker specifies stop frequency. If MKD is off, no operation is performed.

MKSS

Marker to Step Size

Sets the center-frequency step-size to the marker frequency.

Syntax

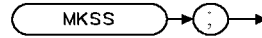

XMKSS

Equivalent `MARKER -> CF STEP`
Softkey:

Related `CF, MKA, MKCF, MKD, MKF, SS`
Commands:

Example

This example measures a harmonic of the CAL OUT signal.

```
10 DISP "CONNECT THE CAL OUT TO THE INPUT"
20 OUTPUT 718;"IP;SNGLS;CF 300MHZ;SP 20MHZ;TS;"

30 OUTPUT 718;"MKPK HI;MKSS;MKD;CF UP;TS;MKPK HI;"

40 OUTPUT 718;"MKA?;"

50 ENTER 718;Delta_amp

60 OUTPUT 718;"MKF?;"

70 ENTER 718;Delta_freq

80 PRINT "DIFFERENCE IN AMPLITUDE IS ",Delta_amp,"dB"
90 PRINT "DIFFERENCE IN FREQUENCY IS ",Delta_freq,"Hz"
100 END
```

Initializes instrument, activates single-sweep mode, changes center frequency and span, updates trace.

Places the marker on the highest point of the trace, changes the step size to the marker frequency, activates marker delta, increase center frequency, update trace, places the marker at highest point of the trace.

Gets the amplitude of the marker.

Puts the instrument response in the computer variable, Delta_Amp.

Gets the frequency of the marker.

Puts the instrument response in the computer variable, Delta_freq.

Description

The MKSS command sets the center-frequency step-size equal to the marker frequency. If in the delta mode, the step size is set to the delta frequency (absolute value).

MKSTOP

Marker Stop

Stops the sweep at the active marker.

Syntax



XMKSTOP

Equivalent Softkey: `MARKER -> STOP`

Related Commands: `MKCONT`

Example

```
10 OUTPUT 718;"IP;TS;"           Initializes instrument.
20 OUTPUT 718;"MKPK HI;"         Creates an active marker.
30 OUTPUT 718;"MKSTOP;"         Stops sweep at marker.
40 OUTPUT 718;"MKCONT;"         Resumes sweep.
50 END
```

Description

The MKSTOP command stops the sweep at the active marker.

MKTRACE Marker Trace

Moves the active marker to a corresponding position.

Syntax

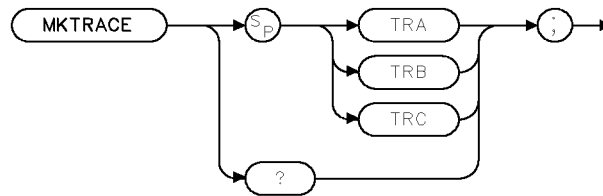

XMKTRACE .

Equivalent Softkey: `MK TRACE AUTO ABC`

Example

10 OUTPUT 718;"IP;"	<i>Initializes instrument.</i>
20 OUTPUT 718;"MKMIN;"	<i>Finds the lowest amplitude of trace.</i>
30 OUTPUT 718;"MKTRACE TRB;"	<i>Moves marker to corresponding position on trace B.</i>
40 OUTPUT 718;"BLANK TRA;CLRW TRB;"	<i>Blanks trace A and displays trace B.</i>
50 END	

Description

The MKTRACE command moves the active marker to a corresponding position in trace A, trace B, or trace C.

Query Response

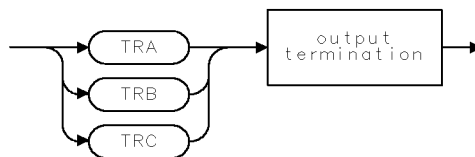

QMKTRACE .

MKTRACK

Marker Track

Moves the signal at the active marker, to the center of the instrument display.

Syntax

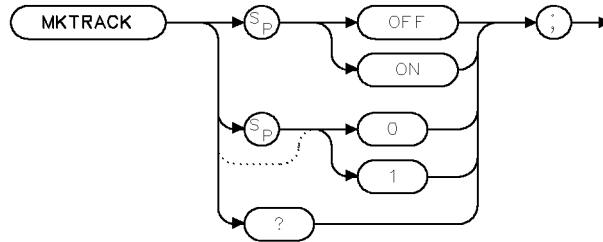

XMKTRACK .

Equivalent Softkey: **MK TRACK ON OFF**

Related Commands: MKA, MKCF, MKF

Example

OUTPUT 718;"IP;"	<i>Initializes instrument.</i>
OUTPUT 718;"CF 300MHZ;TS;"	<i>Changes the center frequency.</i>
OUTPUT 718;"MKTRACK ON;"	<i>Activates the marker track.</i>
OUTPUT 718;"SP 10MHZ;TS;"	<i>Changes the span.</i>
OUTPUT 718;"MKTRACK OFF;"	<i>Turns off the marker track.</i>

Description

The MKTRACK command moves the signal at the active marker, to the center of the display and keeps the signal peak at center screen. To keep a drifting signal at center screen, place the active marker on the desired signal before turning on MKTRACK.

Query Response

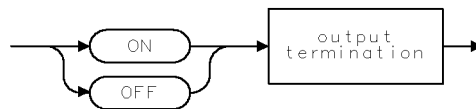

Q02 .

MKTYPE Marker Type

Changes the type of the current active marker.

Syntax

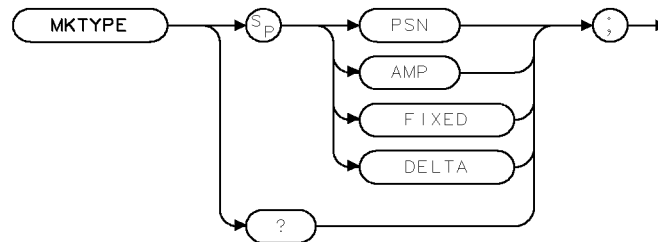

QMKTYPE .

Preset State: MKTYPE PSN

Related Commands: MKA, MKBW

Example

OUTPUT 718;"MKTYPE AMP;MKA 50;" *Positions the marker at 50 dB μ V*

Description

The MKTYPE command changes the type of the current active marker. The marker types are as follows:

PSN allows markers to be positioned according to the horizontal position on the display. The marker type is set to PSN after an instrument preset.

AMP allows markers to be positioned according to amplitude, as shown in the example. If two or more points on the trace are at the same amplitude, the marker is moved to the closest point on the trace with the correct amplitude. If no point on the trace is at the specified amplitude, the marker is placed at the specified amplitude and not on the trace.

FIXED allows a marker to be placed at any fixed point on the instrument screen. The position of the marker cannot be changed unless another marker type is used.

DELTA allows the marker frequency to be positioned with respect to another marker.

Use "MKTYPE PSN" to return from using the AMP, FIXED, or DELTA types.

Query Response

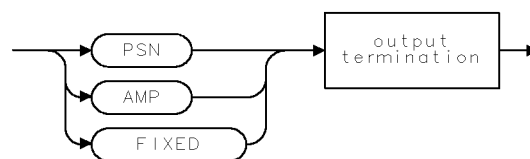

QMKTYPE .

MKTYPE Marker Type

ML Mixer Level

Specifies the maximum signal level that is applied to the input mixer.

Syntax

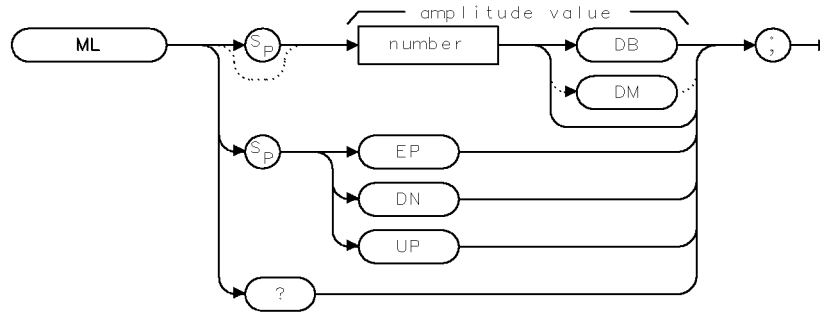

XML

Item	Description/Default	Range
Number	Any real or integer number. Default unit is dBm.	-10 to -60 dBm.

Equivalent Softkey: **MAX MXR LEVEL**

Preset State: -10 dBm

Step Increment: by 10 dBm

Related Commands: AT, ROFFSET

Example

```
OUTPUT 718;"ML -40DM;"
```

As the reference level is changed, the coupled input attenuator is changed automatically. This limits the maximum signal at the mixer input to -40 dBm for signals less than or equal to the reference level.

Description

The ML command specifies the maximum signal level that is applied to the input mixer for a signal that is equal to or below the reference level.

The effective mixer level is equal to the reference level minus the input attenuator setting. When ML is activated, the effective mixer level can be set from -10 dBm to -60 dBm in 10 dB steps.

Query Response

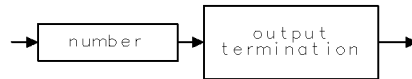

001

MOD

Modulo

Stores the remainder from the division of source 1 by source 2 in the destination.

Syntax

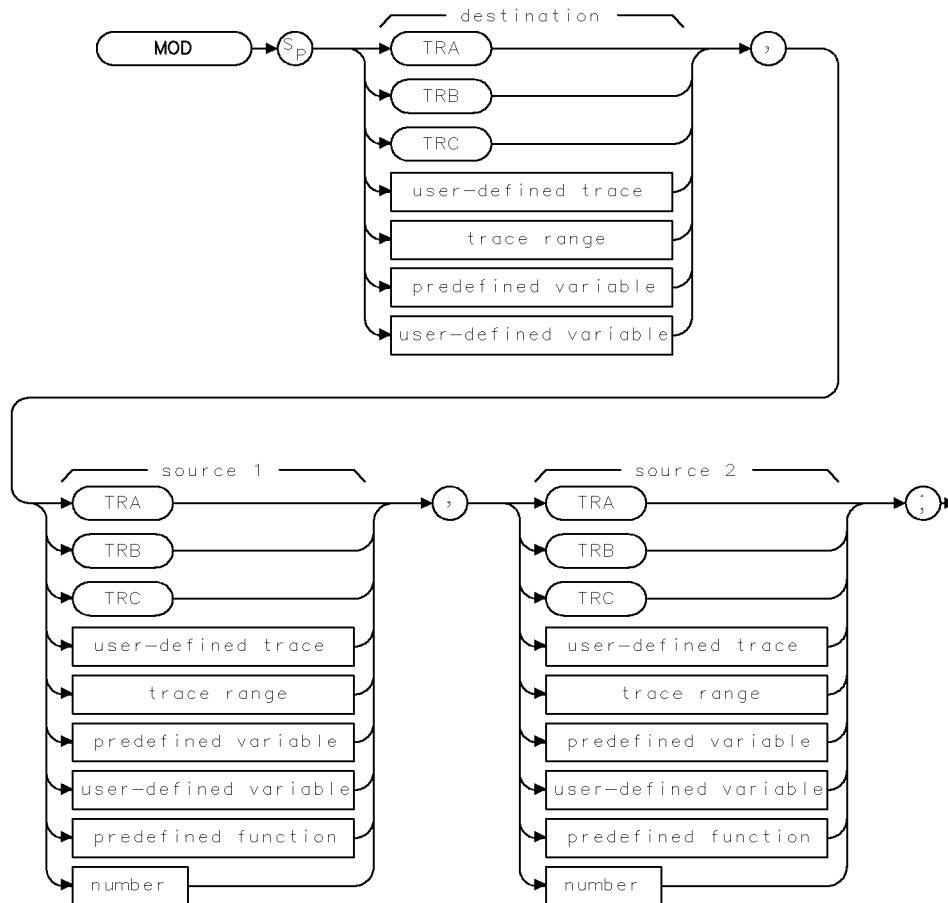

XMOD

Item	Description/Default	Range
User-defined trace	A trace defined by the TRDEF command.	Any valid trace name.
User-defined variable	A variable defined by VARDEF command.	Any valid variable name.
Predefined variable	A command that acts as a variable. Refer to Table 4-1.	
Predefined function	Function that returns a value. Refer to Table 4-1.	
Trace range	A segment of trace A, trace B, trace C, or a user-defined trace.	
Number	Any real or integer number.	Real number range.

Prerequisite Commands: TRDEF when using a user-defined trace. VARDEF when using a user-defined variable. TS when using trace data.

Related Commands: DIV

Example

10 OUTPUT 718;"VARDEF S_ONE,15;"	<i>Places 15 into S_ONE.</i>
20 OUTPUT 718;"VARDEF S_TWO,4;"	<i>Places 4 into S_TWO.</i>
30 OUTPUT 718;"VARDEF D_EST,0;"	<i>D_EST holds the result.</i>
40 OUTPUT 718;"MOD D_EST,S_ONE,S_TWO;"	
50 OUTPUT 718;"D_EST?;"	<i>Moves the result to the computer.</i>
60 ENTER 718;Number	<i>Puts the instrument response in the computer variable, Number.</i>
	<i>Displays a 3.</i>
70 DISP Number	
80 END	

Description

The MOD command stores the remainder from the division of source 1 by source 2 in the destination.

If source 1 is a negative number and source 2 is a positive number, the MOD function returns a negative remainder. If both sources are negative, the MOD function returns a negative remainder.

Integer values are used when a trace is the destination or one of the sources. If trace data is used as the source and the destination, the MOD function is done with 32-bit arithmetic using 16-bit integer data. If a user-defined variable or predefined variable is used as the source or destination, the MOD function is done in floating point format. If a real number is used as a source, but the destination is an integer value, the result is truncated. If a trace is used as a source, be sure the trace contains a complete sweep of measurement information before executing MOD.

When the source is longer than the destination, the source is truncated to fit. When the source is shorter than the destination, the last element is repeated to fill the destination.

MOV

Move

Copies the source values into the destination.

Syntax

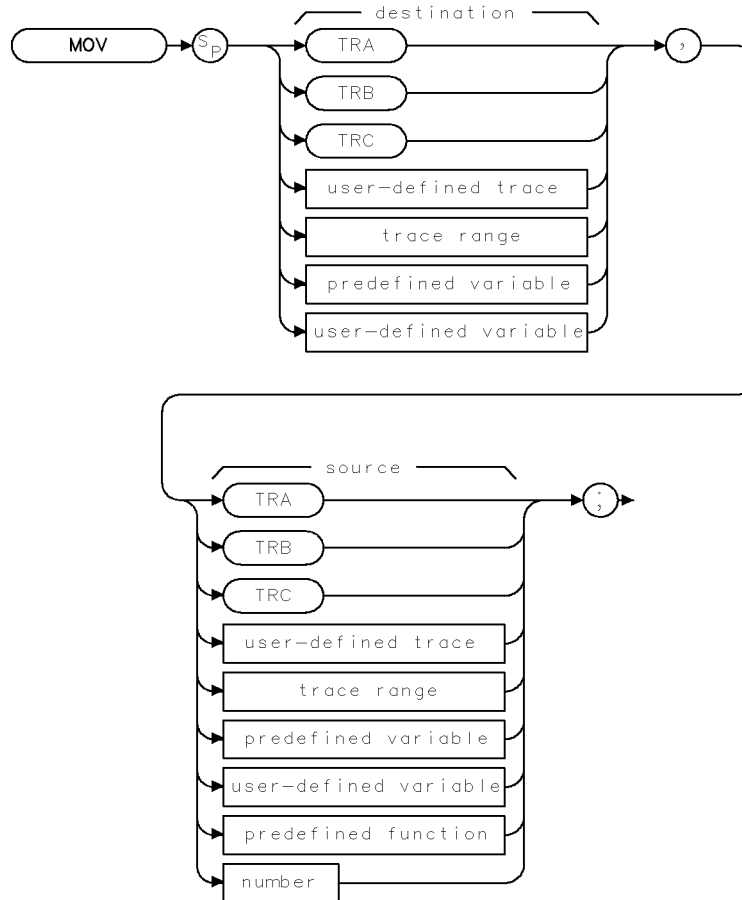

XMOV

Item	Description/Default	Range
User-defined trace	A trace defined by the TRDEF command.	Any valid trace name.
User-defined variable	A variable defined by VARDEF command.	Any valid variable name.
Predefined variable	A command that acts as a variable. Refer to Table 4-1.	
Predefined function	Function that returns a value. Refer to Table 4-1.	
Trace range	A segment of trace A, trace B, trace C, or a user-defined trace.	
Number	Any real or integer number.	Real number range.

Prerequisite Commands: TRDEF when using a user-defined trace. VARDEF when using a user-defined variable.

Example

10 CLEAR 718	<i>Clears the HP-IB bus and instrument.</i>
20 OUTPUT 718;"IP;"	<i>Initializes instrument.</i>
30 OUTPUT 718;"FA 100MHZ;FB 1100MHZ;"	<i>Sets up the measurement range.</i>
40 OUTPUT 718;"TS;MKPK HI;"	<i>Places a marker at the highest peak.</i>
50 OUTPUT 718;"DL ON;"	<i>Turns on display line.</i>
60 OUTPUT 718;"MOV DL,MKA;"	<i>Sets the display-line value equal to the marker amplitude by storing the value of the marker amplitude variable, MKA, in the display line variable, DL.</i>
70 END	

Description

The MOV command copies the source values into the destination. When the source is longer than the destination, the source is truncated to fit. When the source is shorter than the destination, the last element is repeated to fill the destination.

MPY

Multiply

Multiplies the sources.

Syntax

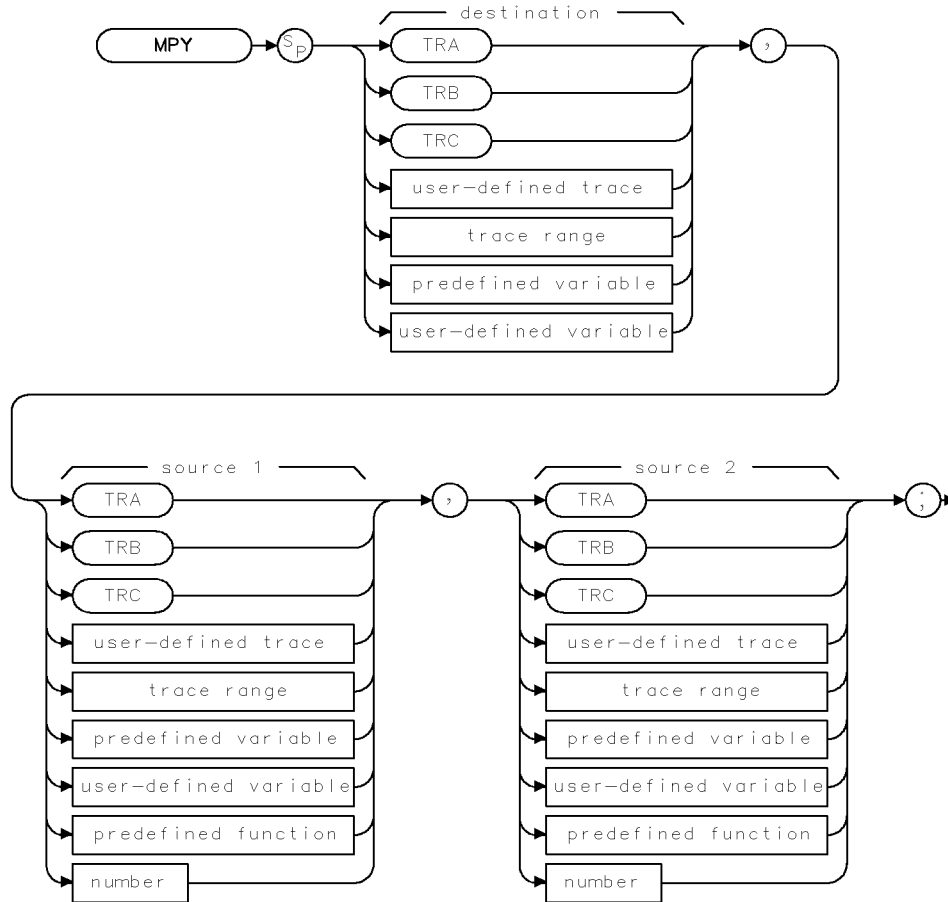

XMPY

Item	Description/Default	Range
User-defined trace	A trace defined by the TRDEF command.	Any valid trace name.
User-defined variable	A variable defined by VARDEF command.	Any valid variable name.
Predefined variable	A command that acts as a variable. Refer to Table 4-1.	
Predefined function	Function that returns a value. Refer to Table 4-1.	
Trace range	A segment of trace A, trace B, trace C, or a user-defined trace.	
Number	Any real or integer number.	Real number range.

Prerequisite Commands: TRDEF when using a user-defined trace. VARDEF when using a user-defined variable. TS when using trace data.

Example

OUTPUT 718;"MPY CF,CF,2;" *Doubles the center frequency.*

Description

The MPY command multiplies the sources, point by point, and places the results in the destination.

Traces, user-defined traces, and trace ranges are multiplied as 16-bit integers. Negative numbers are represented in two's complement format. Single variables and numbers are treated as floating point numbers and must be within the real number range as defined in Table 4-1.

When the source is longer than the destination, the source is truncated to fit. When the source is shorter than the destination, the last element is repeated to fill the destination.

MSI

Mass Storage Is

Specifies the current mass storage device as the internal memory or a disk drive.

Syntax

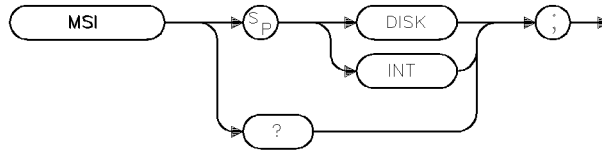

xmsi

Related Commands: CAT
Preset State: DISK

Example

OUTPUT 718;"MSI DISK;" *Selects the disk drive as the current mass storage device.*

Description

The MSI command specifies the current mass storage device as the internal memory or a disk drive.

If you specify INT, the current mass storage device is set to internal memory.

If MSI is used as a predefined variable, it returns a "0" if the mass storage device is the internal memory and a "2" if it is the disk drive.

Query Response

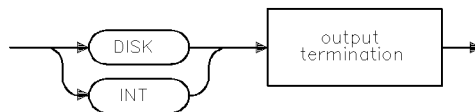

QMSI

MXM Maximum

Compares source 1 and source 2.

Syntax

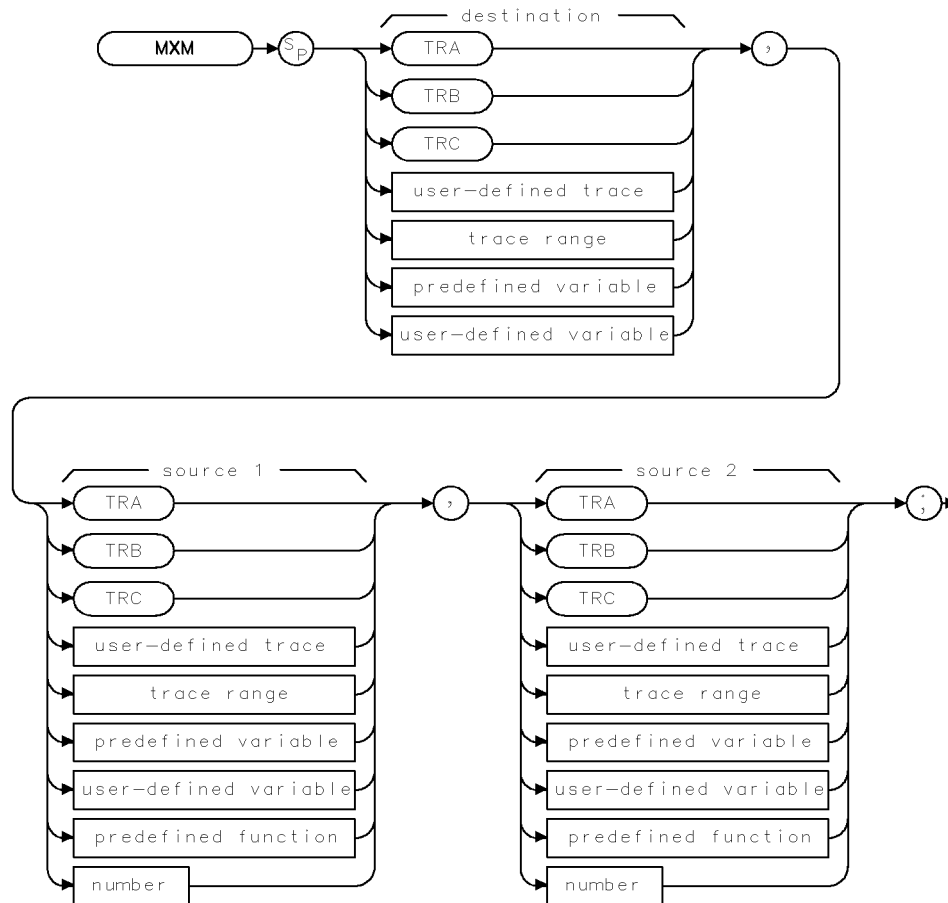

MXM

Item	Description/Default	Range
User-defined trace	A trace defined by the TRDEF command.	Any valid trace name.
User-defined variable	A variable defined by VARDEF command.	Any valid variable name.
Predefined variable	A command that acts as a variable. Refer to Table 4-1.	
Predefined function	Function that returns a value. Refer to Table 4-1.	
Trace range	A segment of trace A, trace B, trace C, or a user-defined trace.	
Number	Any real or integer number.	Real number range.

Prerequisite Commands: TRDEF when using a user-defined trace. VARDEF when using a user-defined variable. TS when using trace data.

Related Commands: MIN, PKPOS, TS

MXM Maximum

Example

10 OUTPUT 718;"IP;"	<i>Initializes instrument.</i>
20 OUTPUT 718;"CF 300MHZ;SNGLS;"	<i>Changes the center frequency and activate single-sweep mode.</i>
30 OUTPUT 718;"TS;VIEW TRA;"	<i>Updates trace. Displays and stores the results of trace A.</i>
40 OUTPUT 718;"MXM TRB,TRA,4000;"	<i>Moves elements of trace A that exceed 4000 trace data points (above center screen) to trace B.</i>
50 OUTPUT 718;"BLANK TRA;VIEW TRB;"	<i>Displays result.</i>
60 END	

Description

The MXM command compares source 1 and source 2, point by point, sending the greater value of each comparison to the destination.

If one of the sources is a single value, it acts as a threshold; all values equal to or greater than the threshold pass to the destination.

When the source is longer than the destination, the source is truncated to fit. When the source is shorter than the destination, the last element is repeated to fill the destination.

MXMH Maximum Hold

Updates each trace element with the maximum level detected.

Syntax

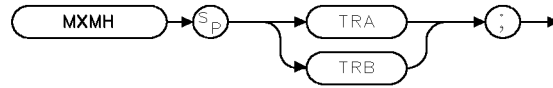

MXMH

Equivalent Softkeys: **MAX HOLD A** and **MAX HOLD B**

Related Commands: BLANK, CLRW, MINH, VAVG, VIEW

Example

```
OUTPUT 718;"MXMH TRA;"
```

Description

MXMH updates the specified trace (either trace A or trace B) with a new value from a detector only if the new value is larger than the previous trace data value.

NRL

Normalized Reference Level

Sets the normalized reference level.

Syntax

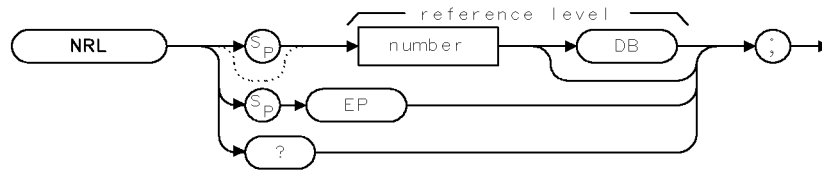

XNRL

Item	Description/Default	Range
Number	Any real or integer number. Default unit is dB μ V.	

Preset State: 0 dB

Related Commands: MEASURE, RL, RLPOS

Example

```

10  OUTPUT 718;"IP;"
20  OUTPUT 718;"SRCPWR 80DB;"
30  PRINT "CONNECT TRACKING GENERATOR OUTPUT TO INPUT"
40  PRINT "THEN PRESS CONTINUE"
50  PAUSE
60  OUTPUT 718;"MEASURE SR;"
70  OUTPUT 718;"CLRW TRB;TS;"
80  OUTPUT 718;"BLANK TRB;"
90  PRINT "CONNECT DEVICE TO INSTRUMENT"
100 PRINT "THEN PRESS CONTINUE"
110 PAUSE
120 OUTPUT 718;"CLRW TRA;TS;"
130 OUTPUT 718;"AMBPL ON;"
140 OUTPUT 718;"RLPOS 4;"
150 OUTPUT 718;"SUB NRL,RL,40;"
160 END

```

Initializes instrument.

Sets tracking generator output.

Sets the measurement mode to stimulus-response.

Takes a measurement sweep of the flatness of the system.

Takes a measurement sweep of the device under test in the system.

Normalizes the response.

Changes the location of the reference level to the fourth graticule from the bottom.

Offsets trace A so it is on-screen. (Subtract 40 dB from the reference level.)

Description

The NRL command sets the normalized reference level. This function is a trace-offset function that enables you to offset the displayed trace without introducing hardware-switching errors into the stimulus-response measurement. The input attenuator and IF step gains are not affected when using NRL.

In absolute power mode ($\text{dB}\mu\text{V}$), reference level affects the gain and RF attenuation settings of the instrument, which affects the measurement or dynamic range. In normalized mode (relative power or dB-measurement mode), NRL offsets the trace data onscreen and does not affect the instrument gain or attenuation settings. This allows the displayed normalized trace to be moved without decreasing the measurement accuracy due to changes in gain or RF attenuation. If the measurement range must be changed to bring trace data onscreen, then the range level should be adjusted. Adjusting the range-level normalized mode has the same effect on the instrument settings as does reference level in absolute power mode (normalize off).

Query Response

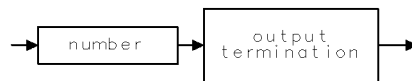

001

OA

Output Active Function Value

Sends the value of the active function to the controller.

Syntax

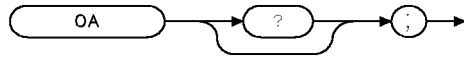

XOA

Example

```
10 OUTPUT 718;"ST 3SC;OA;" Changes the sweep time, activates the OA command.
20 ENTER 718;Number Gets the response from the instrument.
30 DISP Number Displays "3" on the computer screen.
40 END
```

Description

The OA command sends the value of the active function to the controller.

Query Response

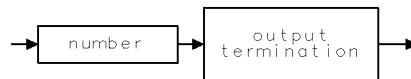

Q01

OL Output Learn String

Transmits information to the controller.

Syntax

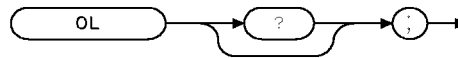

XOL

Related Commands: RCLS, SAVES

Example

```

10 DIM Learn_String$[202]
20 OUTPUT 718;"OL;"
30 ENTER 718 USING "#,202A"; LEARN_STRING$
40 DISP "CHANGE INSTRUMENT TO ANOTHER STATE,
    THEN CONTINUE TO RESTORE FIRST STATE;"
50 PAUSE
60 OUTPUT 718; LEARN_STRING$

70 END
    
```

Allocates memory space for the Learn_String.

Asks for first state.

Computer receives the information.

Returns the instrument to its former state (when OL was first activated in line 20).

Description

The OL command transmits information to the controller that describes the state of the instrument when the OL command is executed. The information received from the instrument is called the learn string. The learn string can be sent from the controller back to the instrument to restore the instrument to its original state.

The learn string requires 202 bytes of storage space. See “Saving and Recalling Instrument States,” in Chapter 3 for more information.

To restore the instrument to the learn string state, you must return the learn string to the instrument. The learn string contains information to tell the instrument that it is learn string data. (Also see “RCLS” and “SAVES.”)

Query Response

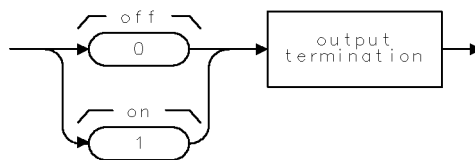

Q03

OVLD Overload

Enables or disables RF and IF overload status and returns overload status.

Syntax

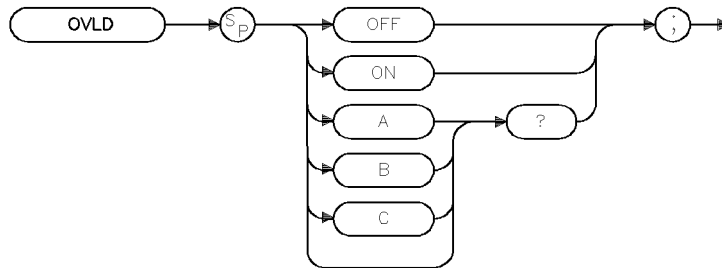

xovld

Equivalent Softkey: **OVLD ON OFF**
Preset State: OVLD ON
Related Commands: ARNG, AT, RL, RQS, SRQ

Example

```
10 OUTPUT 718;"OVLD ON;"
```

Description

The OVLD command enables, disables, or queries the current RF and IF overload status (the status is always returned, not only on a query).

OVLD returns a 16-bit integer value upon every execution of the command. Return values are covered below.

Note If overload detection is enabled, the instrument will issue a service request (SRQ) and set bit 0 in the HP-IB status byte, at the end of the sweep, in which an overload is detected. You can query OVLD to ascertain the type of overload detected. The instrument will not issue a service request if a trace which has an associated overload is brought into VIEW from being BLANKed. However, an overload message will be displayed on the instrument screen.

Note Overload status for a given sweep is valid from the end of that sweep up to the end of the next sweep. Overload status for each sweep is re-evaluated at the end of sweep. However, the HP-IB status byte will not be cleared at the time overload status is re-evaluated. In continuous sweep, it is possible for the user to get an HP-IB service request which indicates that an overload had been detected, but upon querying the OVLD command, no overload will be indicated. For this reason, it is recommended that the instrument be in single-sweep mode.

Overload status for the instrument's primary traces (A, B, and C) are maintained separately from overload status of each sweep. User traces have no associated overload status. Trace overload status is re-evaluated when data is written to that trace or when the trace is cleared. Thus, it is possible to see overload messages on the display, even if overload detection is disabled under the following conditions; if you were to recall or view a trace which was taken when overload detection was enabled and experienced an overload condition.

Query Response

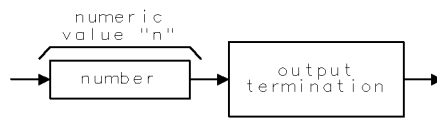

govld

Bit Postion	Bit Status = 0	Bit Status = 1
0	Overload detection disabled.	Overload detection enabled.
1	RF overload not detected.	RF overload detected.
2	IF overload not detected.	IF overload detected.
3	RF attenuation not at max.	Maximum RF attenuation.

If n=15 then, overload detection is enabled, RF overload on specified trace is detected, IF overload detection on specified trace is detected, and system RF attenuation is at maximum.

Note If overload detection is disabled, only OVLD commands which query status of specified traces (OVLD A?;, OVLD B?;, or OVLD C?;) will return status information other than "0" (disabled). "OVLD ?;" will return "0" if overload detection is disabled no matter the setting of the instrument's RF attenuation.

PDA

Probability Distribution of Amplitude

Sums the probability distribution of amplitude in the destination trace with the amplitude distribution function of the source trace.

Syntax

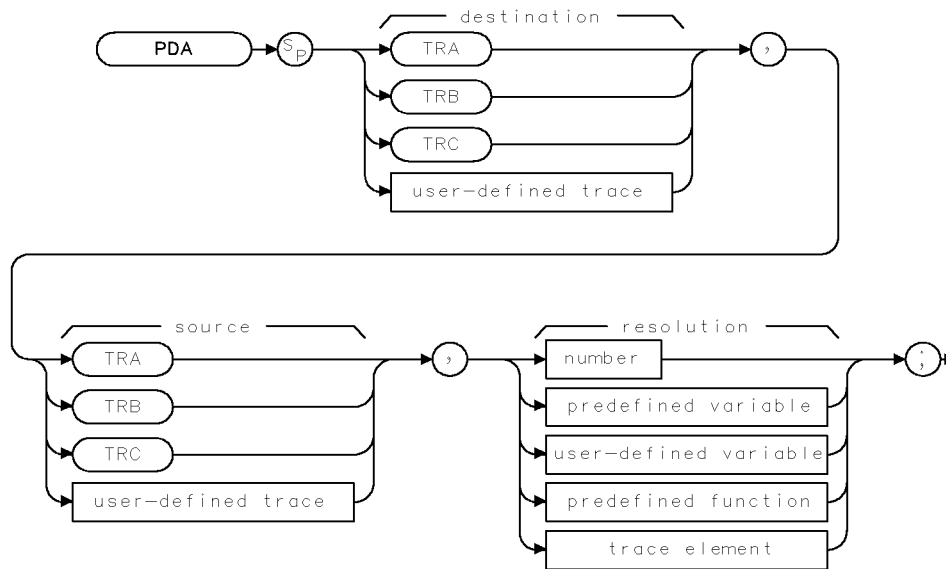

XPDA

Item	Description/Default	Range
User-defined trace	A trace defined by the TRDEF command.	Any valid trace name.
Number	Any real or integer number.	Real number range.
User-defined variable	A variable defined by VARDEF command.	Any valid variable name.
Predefined variable	A command that acts as a variable. Refer to Table 4-1.	
Predefined function	Function that returns a value. Refer to Table 4-1.	
Trace element	An element of trace A, trace B, trace C, or a user-defined trace.	

Prerequisite Commands: TRDEF when using a user-defined trace. VARDEF for a user-defined variable. TS when using trace data.

Related Commands: RMS

Example

OUTPUT 718;"IP;SNGLS;"	<i>Initializes instrument and activates the single-sweep mode.</i>
OUTPUT 718;"AVBW 10KHZ;HD;TS;"	<i>Changes average video bandwidth, updates trace.</i>
OUTPUT 718;"MOV TRB,0;"	<i>Replaces trace B data with all zeros.</i>
OUTPUT 718;"PDA TRB,TRA,1;"	<i>Determines the distribution of trace A and sums results into trace B.</i>

PDA Probability Distribution of Amplitude

OUTPUT 718;"MPY TRB,TRB,5;"	<i>Multiplies values in trace B by 5 to make the results more visible.</i>
OUTPUT 718;"VIEW TRB;"	<i>Displays the result.</i>

Description

The PDA command sums the probability distribution of amplitude in the destination trace with the amplitude distribution function of the source trace.

The PDA command takes the data in the source trace on a point-by-point basis. Each amplitude value is divided by 100 times resolution value, and the result of the division is rounded to an integer. If the result falls within the range of the buckets of the destination trace, the content of the corresponding destination trace element is increased by one. For example, to show the distribution of amplitudes on a trace with values ranging from 0 to 8000, a resolution value of 1 dB would result in 81 buckets $((8000/(1 \times 100))+ 1)$. Amplitude values ranging from 0 to 99 would go to bucket 1, values from 100 to 199 would go into bucket 2, and so forth. Finally, values from 7900 to 7999 would go to bucket 400. An amplitude value of 8000 would fall into bucket 81.

Due to the summing nature of the PDA command, the destination trace should always be initialized to all zeros.

The PDA function is similar to the probability density function in statistics. The probability density function has the y -axis as the probability of an occurrence, where the PDA function of the EMI receiver has the number of occurrences as its y -axis. The PDA could be converted to a probability density function by dividing, in an external controller, the value of each bucket by the total number of source elements. Note that performing the divide inside the instrument would not be appropriate because the result is less than 1, which would be truncated to 0.

PEAKS

Peaks

Sorts signal peaks by frequency or amplitude.

Syntax

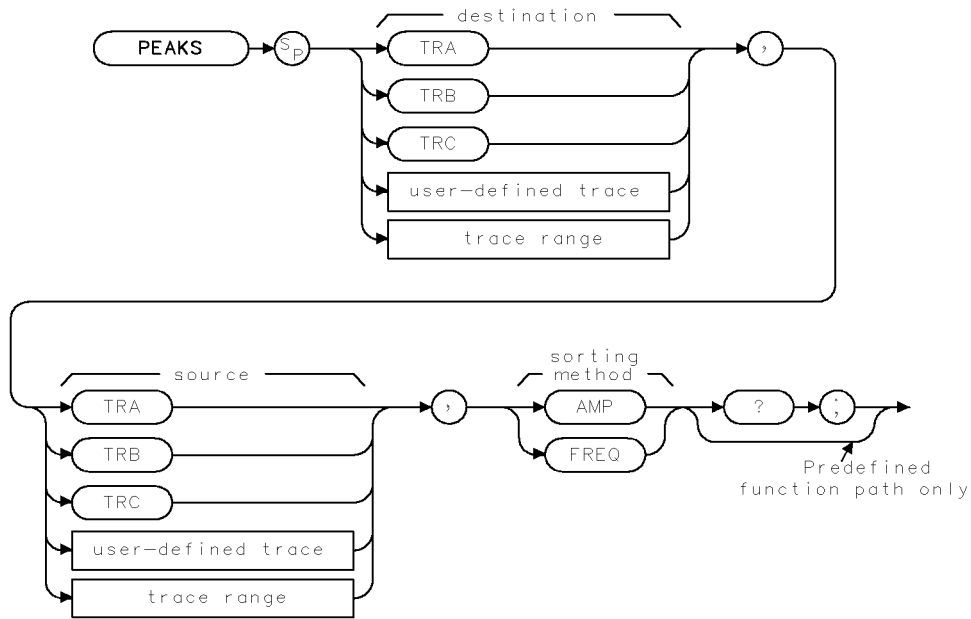

XPEAKS

Item	Description/Default	Range
User-defined trace	A trace defined by the TRDEF command.	Any valid trace name.
Trace range	A segment of trace A, trace B, trace C, or a user-defined trace.	

Prerequisite Commands: TRDEF when using a user-defined trace. TS when using trace data.

Related Commands: MKPX, TH

Example

OUTPUT 718;"IP;CALSW INT;"

Initializes instrument.

OUTPUT 718;"CF 300MHZ;SP 1500MHZ;IFBW 30KHZ;SNGLS;"

Changes the center frequency, span, bandwidth. Activates single-sweep mode.

OUTPUT 718;"TH 35DB

Sets up threshold, sets minimum peak excursion.

OUTPUT 718;"PEAKS TRB,TRA,FRQ?;"

Returns the number of peaks in trace A above the threshold.

PEAKS Peaks

ENTER 718;Number	<i>Gets the number of peaks from the instrument.</i>
DISP Number	<i>Displays the result on the computer screen.</i>
FOR I=1 TO Number	<i>For one to the number of peaks, do the following steps.</i>
OUTPUT 718;"MKP TRB[";I;"]";	<i>Place marker at the position of the first trace B element.</i>
OUTPUT 718;"MKA?;"	<i>Find the amplitude of the marker.</i>
ENTER 718;A	
OUTPUT 718;"MKF?;"	<i>Find the frequency of the marker.</i>
ENTER 718;B	
PRINT A,B	<i>Print the amplitude and the frequency of the marker.</i>
NEXT I	<i>Repeat the FOR NEXT loop for all of the peaks that were found.</i>

Description

The PEAKS command sorts signal peaks by frequency or amplitude, stores the results in the destination trace, and returns the number of peaks found.

When sorting by frequency (FREQ), PEAKS first computes the horizontal position of all peaks. These positions are loaded into the destination trace consecutively, with the lowest frequency value occupying the first element. Thus, signal frequencies, from low to high, determine the amplitude of the destination trace from left to right.

When sorting by amplitude (AMP), PEAKS first computes the amplitudes of all peaks in the source trace in measurement units, and sorts these values from high to low. The positions of the peaks are then loaded into the destination trace, with the position of the highest amplitude value occupying the first element.

PEAKS Peaks

If the `FREQ` parameter is used with the `PEAKS` command, the programming example returns the values that shown in the following table.

Trace Element	Amplitude dB μ V	Frequency Hertz
TRB[1]	78.02	-3E+8
TRB[2]	92.98	4.E+6
TRB[3]	78.79	3.04E+8
TRB[4]	64.71	6.04E+8
TRB[5]	74.31	9.07+8

If the `AMP` parameter is used with the `PEAKS` command, the programming example returns the values that are shown in the following table.

Trace Element	Amplitude dB μ V	Frequency Hertz
TRB[1]	93.05	4.E+6
TRB[2]	78.86	3.04E+8
TRB[3]	78.11	-2.96E+8
TRB[4]	74.40	9.07E+8
TRB[5]	64.77	6.08+8

Notice that `MKA?` and `MKF?` are used to determine the amplitude and frequency of the peak position.

`PEAKS` sorts only signals that are above the threshold value. To be classified as a signal peak, a signal must be `MKPX` above the threshold value and it must rise and fall at least the peak excursion (`MKPX` value). To change the threshold, use the `TH` command before `PEAKS` is executed.

If necessary, the last sorted value is repeated to fill remaining elements of the destination trace.

`PEAKS` must be used as either a query or as a source in another instrument-command function. Form a query by ending the `PEAKS` statement with a “?” When used as a query, `PEAKS` returns the number of peaks found. When querying the trace elements of destination trace, the x -axis coordinate (relative to the first trace element) of the peak is returned.

Query Response

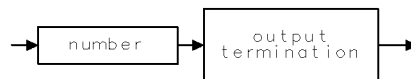

001

PLOT Plot

Initiates a plotter output of the screen data to the remote interface.

Syntax

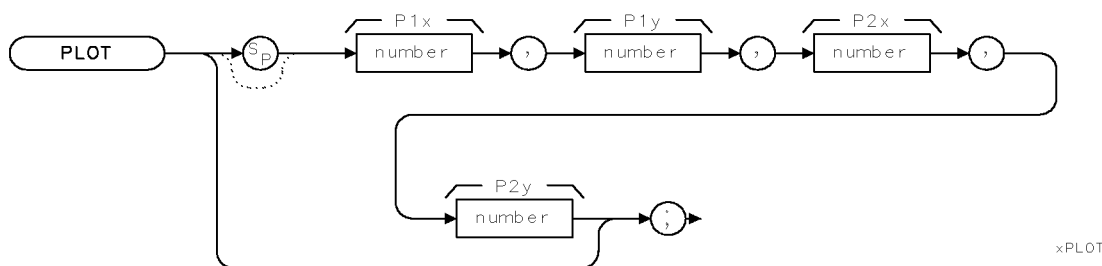

Item	Description/Default	Range
Number	Any real or integer number.	Number within the plotter coordinates.

Related Commands: PRINT, SNGLS, TS

Example for the HP-IB Interface

The plotter is at address 5 and the instrument is at address 18 in this example. (The program is only valid for HP 9000 series 200 and 300 computers.)

This example illustrates how an external controller can initiate the sending of print data to an external printer.

```

10 DIM P$[80]           Allocates room in memory.
20 OUTPUT 705;"OP;"     Plotter outputs lower-left and upper-right display
                        dimensions.
30 ENTER 705;P$         Puts the plotter response in the computer string.
40 OUTPUT 718;"PLOT";P$ Plots the display according to the dimensions stored
                        in the computer string.
50 SEND 7;LISTEN 5 TALK 18 DATA Configures the interface to output data from instru-
                        ment to plotter.
60 END
    
```

PLOT Plot

Description

The PLOT command transfers the trace data, graticule, and annotation of the screen to a plotter via the instrument interface (softkey labels excluded). The data is transferred in ASCII, HPGL format.

The example routes the data to an external plotter; however, the controller can read the data into a string if desired.

When using the PLOT command, the scaling points (P1x, P1y; P2x, P2y) can be specified. These scaling points specify the (x,y) coordinates, which determine the size of the plot. (P1x,P1y) refers to the lower-left plotter coordinates. (P2x,P2y) refers to the upper-right plotter coordinates.

Note The HP 7470A plotter does not support 2 plots per page. If you use an HP 7470A plotter with an HP 8542E/HP 8546A EMI receiver or HP 85422E/HP 85462A receiver RF section, you can select one plot per page or four plots per page but not 2 plots per page.

POWERON Power-On State

Selects the state of the instrument when the instrument is turned on.

Syntax

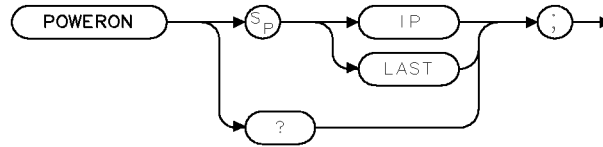

XPOWERON .

Equivalent Softkeys: `POWER ON IP LAST`

Example

```
OUTPUT 718;"POWERON LAST;"
```

Description

The POWERON command selects the state of the instrument when the instrument is turned on: the IP state (same state as an instrument preset command) or last state (the state the instrument was in when it was turned off).

Limit-line testing is not considered to be a instrument state and is not resumed after the instrument is turned off. The limit-line table will be restored even if the instrument is turned off.

Note The last state of the instrument is not retained in the case of battery power failure of the instrument’s internal battery.

When used as a predefined variable, POWERON returns either a “0” or a “1,” depending on the setting of the POWERON parameter. Refer to the following table.

Parameter Setting	Value Returned
IP	0
LAST	1

Query Response

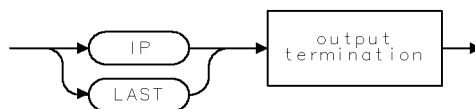

QPOWERON .

PP

Preselector Peak

For an HP 8546A/HP 85462A only.

Peaks the preselector.

Syntax

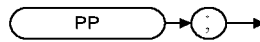

XPP

Equivalent Softkeys: `PRESEL PEAK`

Related Commands: `MKA, MKCF, MKD, MKF, MKN, MKPK`

Example

`OUTPUT 718;"IP;CF 3GHZ;SP 500KHZ;"` *Initializes instrument, changes center frequency, span.*

`OUTPUT 718;"TS;MKPK HI;MKCF;PP;"` *Peaks the highest onscreen signal.*

Description

The PP command peaks the preselector. To use PP, set the desired trace to clear-write mode, place a marker on a desired signal, then execute PP. Commands following PP are not executed until after the instrument has finished peaking the preselector.

PP automatically adjusts the preselector tracking to peak the signal at the active marker. (When the marker is tuned to a signal and `PRESEL PEAK` is pressed, an internal routine searches for the peak response of the preselector and adjusts the tracking accordingly.) Using preselector peak prior to measuring a signal yields the most accurate amplitude reading.

Preselector peak operates with the `MARKER NORMAL` or `MARKER Δ` markers. If the marker is OFF, pressing `PRESEL PEAK` initiates a peak search routine and then peaks the response at that marker; otherwise, it peaks around the active marker. The `CAL:PEAKING` message appears on the active graticule area to indicate operation of the peaking routine. Preselector peak only operates in bands above 2.75 GHz.

PREAMP Preamplifier

Switches the system preamplifier in and out of the input path.

Syntax

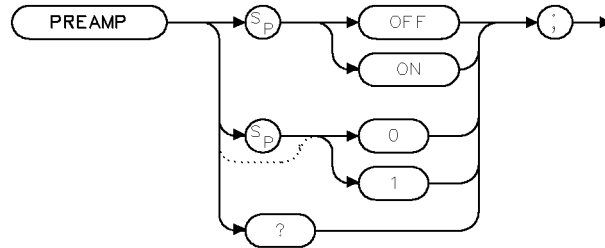

xpreamp .

Equivalent Key: **PREAMP** acts as an ON/OFF toggle switch

Equivalent Softkey: **PREAMP ON OFF**

Preset Value: PREAMP OFF

Related Commands: HAVE RFFS

Example

```
OUTPUT 718; "PREAMP ON;"
```

Description

The PREAMP command switches the system preamplifier in and out of the input path.

With PREAMP ON:

The receiver RF section with the RF filter section adds 12 dB of gain for 9 kHz to 50 MHz (INPUT 1) or 20 MHz to 2.9 GHz (INPUT 2) path excluding the bypass path.

A standalone receiver RF section or a receiver RF section with a RF filter section adds 27 dB of gain from 1 GHz to 6.5 GHz (INPUT 2) and the bypass path (INPUT 2).

Note The 1 GHz to 6.5 GHz (INPUT 2) path is available for an HP 8546A/HP 85462A only.

PREAMP Preamplifier

Note When the RF filter section is present in the system, the following changes to the input path will set PREAMP as follows:

- Moving into 9 kHz to 50 MHz path (INPUT 1) PREAMP OFF
- Moving into 20 MHz to 2.9 GHz path (INPUT 2) PREAMP OFF
- Moving into bypass path (INPUT 2) PREAMP OFF

(For an HP 8546A/HP 85462A only.)

- Moving into 1 GHz to 6.5 GHz path (INPUT 2) PREAMP ON
-

Query Response

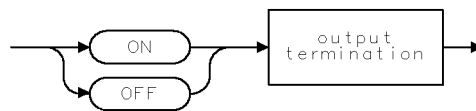

002

PREAMPG External Preamp Gain

Subtracts a positive or negative preamplifier gain value from the displayed signal.

Syntax

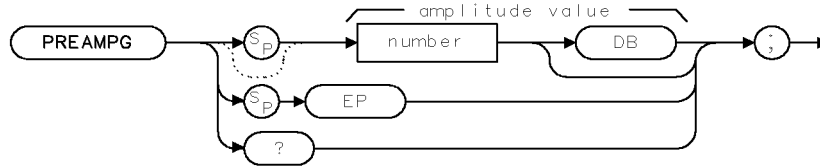

XPREAMPG

Example

```
OUTPUT 718;"PREAMPG 10DB;"
```

Description

The PREAMPG command subtracts a positive or negative preamplifier gain value from the displayed signal. Unlike using ROFFSET, PREAMPG can change the attenuation depending on the preamplifier gain entered.

A preamplifier gain offset is used for measurements that require an external preamplifier or long cables. The offset is subtracted from the amplitude readout so that the displayed signal level represents the signal level at the input of the preamplifier or long cable. The preamplifier gain offset is displayed at the top of the screen and is removed by entering zero.

Note PREAMPG is not reset to 0 by an instrument preset (IP). Be sure to execute "PREAMPG 0;" when the preamplifier gain is no longer needed.

Press **CALIBRATE**, **CAL STORE** if you want the instrument to use the current preamplifier gain offset when power is turned on. Preamplifier gain offset is set to zero by **DEFAULT CONFIG**.

Query Response

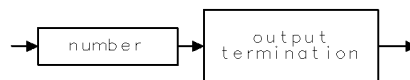

001

PREFIX

Prefix

Specifies or changes the prefix used in save and recall operations.

Syntax

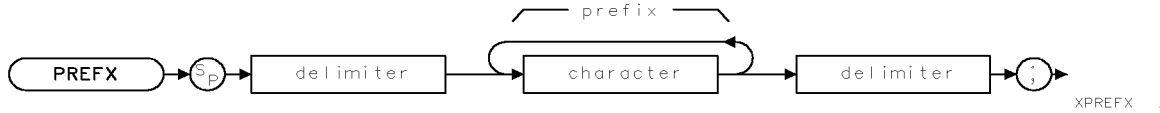

Item	Description/Default	Range
Character	Any valid character.	0 to 6 characters long, A through Z and the underscore (the underscore cannot be the first character of the prefix).
Delimiter	Matching characters marking the beginning and end of the list of instrument commands.	~ \ @ = / ^ \$ % ; ! ' : " &

Equivalent Softkeys: **Change Prefix**

Related Commands: CAT, STOR

Example

```
OUTPUT 718;"PREFIX %DAVE%";
```

Description

The PREFIX command specifies or changes the prefix used in save and recall operations.

PRINT Print

Initiates an output of the screen data to the remote interface.

Syntax

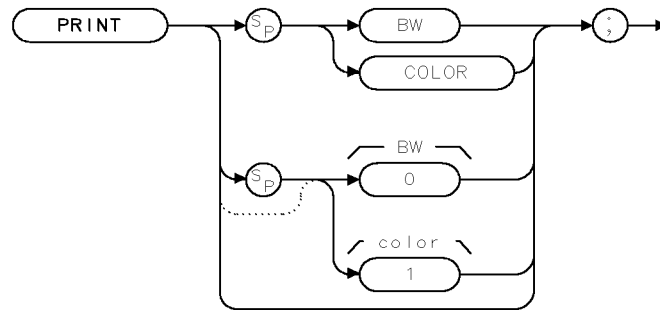

Related Commands: PLOT, PRNTTYPE, PRNTADRS, PRNTRES

Example for the HP-IB Interface

The printer usually resides at address 1 and the plotter at address 5. (The program is only valid for HP 9000 Series 200 and 300 computers and HP Vectra personal computer with a raster graphics printer, such as the HP DeskJet 550C.)

This example illustrates how an external controller can initiate the sending of print data to an external printer.

```

OUTPUT 718; "PRNTTYPE 10;"           Selects DeskJet 550C
OUTPUT 718; "PRNTADRS 1;"
OUTPUT 718; "PRINT COLOR;"
SEND 7;UNT UNL LISTEN 1 TALK 18 DATA Sends data to printer.
    
```

Note To print without disconnecting the computer, you must execute the following BASIC commands:
 ABORT 7
 LOCAL 7
 Then press **COPY**.

Description

The PRINT command initiates an output of the screen data to the remote interface. With appropriate HP-IB commands, the HP-IB can be configured to route the data to an external printer. The data is output in raster graphics format. This format differs for specific printers therefore, it is required to issue a PRNTTYPE command prior to the PRINT command. PRINT, PRINT 0, or PRINT BW produces a monochrome printout. PRINT 1 and PRINT COLOR produces a "color format" output for an HP PaintJet printer. Execute "MENU 0;" before printing to blank the softkeys.

PRNTADRS

Print Address

Sets the HP-IB address of the printer.

Syntax

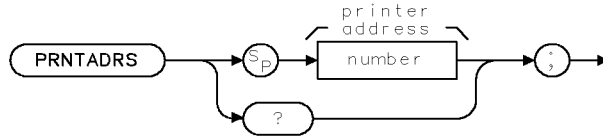

XPRNTADRS

Item	Description/Default	Range
Number	Any valid integer number.	0 to 30

Equivalent Softkeys: **PRINTER ADDRESS**

Related Commands: PRINT, PRNTTYPE, PRNTRES

Example

```

OUTPUT 718; "PRNTTYPE 10;"           Selects DeskJet 550C
OUTPUT 718; "PRNTADRS 1;"
OUTPUT 718; "PRINT COLOR;"
SEND 7;UNT UNL LISTEN 1 TALK 18 DATA Sends data to printer.

```

Description

The PRNTADRS command sets the HP-IB address of the printer. The address is used during execution of the PRINT command and when **COPY** and **REPORT** are pressed.

Query Response

PRNTADRS? returns the current HP-IB address of the printer.

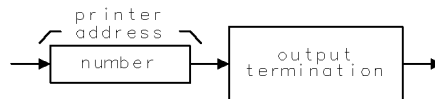

QPRNTADRS

PRNTPPG Prints Per Page

Specifies the number of prints per page for printing.

Syntax

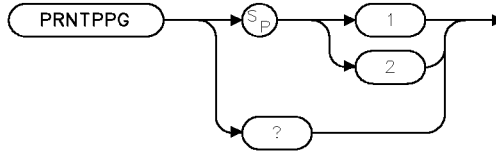

xprtppg .

Item	Description/Default	Range
Number	Any integer.	1 or 2

Equivalent Softkey: `PRN/PG 1 2`

Related Commands: PRNTRES, PRNTTYPE

Example

OUTPUT 718; "PRNTPPG 2;"

Description

The PRNTPPG command specifies the number of prints per page for printing.

Note On some printers 1 print per page will generate a full page printout, other printers are unaffected by the prints per page setting.

Query Response

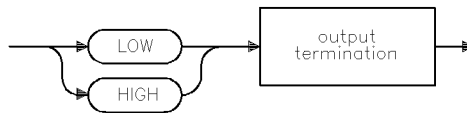

qgen3 .

PRNTRES

Print Resolution

Sets the resolution of subsequent prints.

Syntax

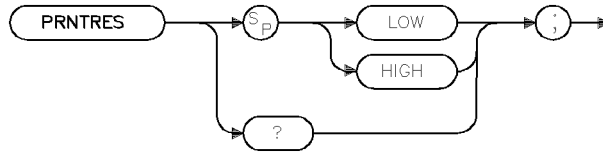

xprtres

Equivalent Softkey: RESOLUTN LOW HIGH

Related Commands: PRNTPPG, PRNTTYPE

Example

OUTPUT 718; "PRNTRES LOW;"

Description

The PRNTRES command sets the subsequent prints to low or high resolution.

Query Response

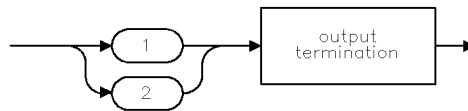

qgen4

PRNTTYPE Printer Type

Specifies which printer is connected to the output port.

Syntax

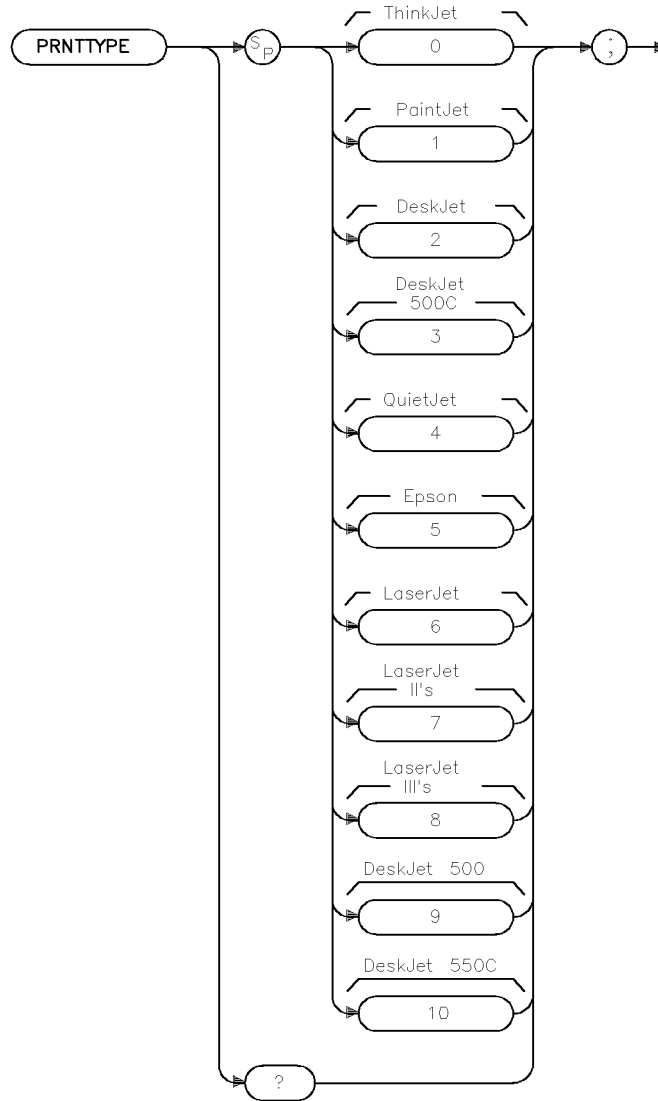

xprttype

Item	Description/Default	Range
Number	Any integer number	0 to 10

Equivalent Softkey: **Printer Type**

Related Command: PRNTRES, PRNTPPG

PRNTTYPE Printer Type

Example

```
OUTPUT 718; "PRNTTYPE 1;"
```

Description

The PRNTTYPE command specifies which printer is connected to the output port. Select your specific printer type from the parameters as defined in the integer index below:

- 0 = ThinkJet
- 1 = PaintJet
- 2 = DeskJet
- 3 = DeskJet 500C
- 4 = QuietJet
- 5 = Epson
- 6 = LaserJet
- 7 = LaserJet II
- 8 = LaserJet III
- 9 = DeskJet 500
- 10 = DeskJet 550C

Query Response

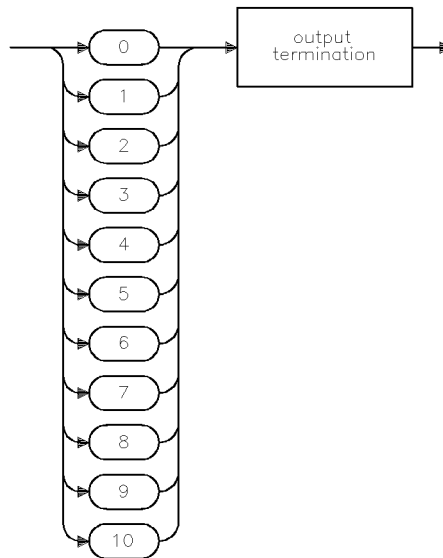

qprtype

PROTECT Protect

Silently overwrites files located on the disk drive, that are the same name.

Syntax

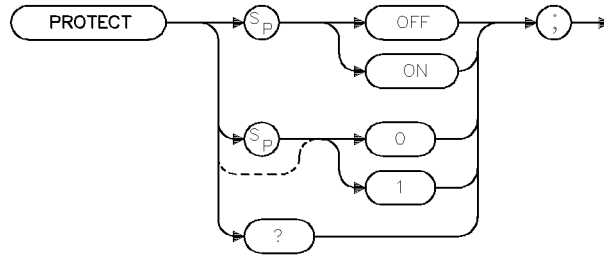

xovrwrt

Equivalent Softkey: **PROTECT ON OFF**

Related Commands: SAVRCLN, STOR

Example

OUTPUT 718; "PROTECT ON;"

Description

The PROTECT command selects whether files on a floppy disk can be silently overwritten in the event that a file by the same name already exists on the medium.

When PROTECT is ON, an illegal command SRQ will be set if you try to overwrite a file that already exists.

Query Response

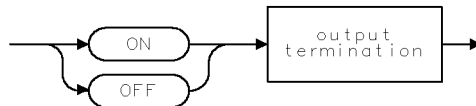

002

PSTATE

Protect State

Protects all of the instrument's user state and trace registers from being changed.

Syntax

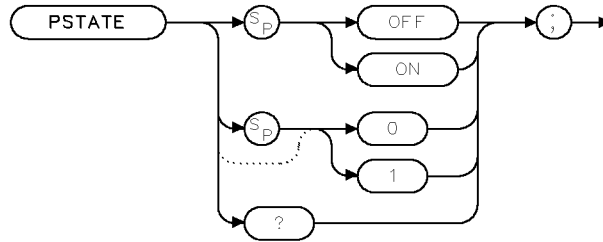

XPSTATE .

Equivalent Softkeys: **SAV LOCK ON OFF**

Related Commands: ERASE, RCLS, SAVES

Example

```
OUTPUT 718;"PSTATE ON;"
```

Description

The PSTATE command protects all of the instrument's user state and trace registers from being changed.

Query Response

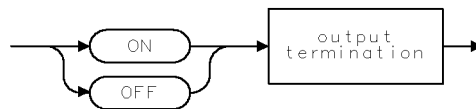

QQ2 .

PURGE Purge File

Deletes the specified file from the current mass storage device.

Syntax

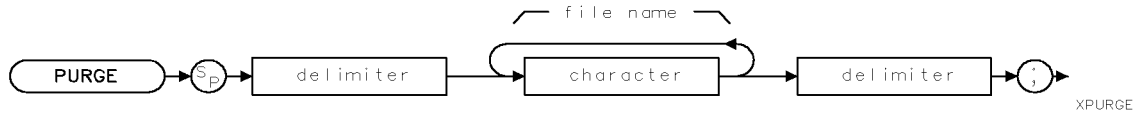

Item	Description/Default	Range
Delimiter	Matching characters marking the beginning and end of the list of instrument commands.	~ \ @ = / ^ \$ % ; ! ' : " &
Character	Any valid character.	Any valid filename.

Equivalent Softkey: **DELETE FILE**

Related Commands: MSI

Example

OUTPUT 718;"MSI DISK;" *Selects the floppy disk as the mass storage device.*
 OUTPUT 718;"PURGE %dMYFILE%;" *Deletes the file called "dMYFILE" from the floppy disk.*

Description

The PURGE command deletes the specified file from the current mass storage device. Use the MSI command to select the mass storage device (either the internal memory or a floppy disk) before using the PURGE command. Files are repacked automatically after a PURGE command is executed, when deleting files from a floppy disk.

PWRBW

Power Bandwidth

Computes the bandwidth around the trace center.

Syntax

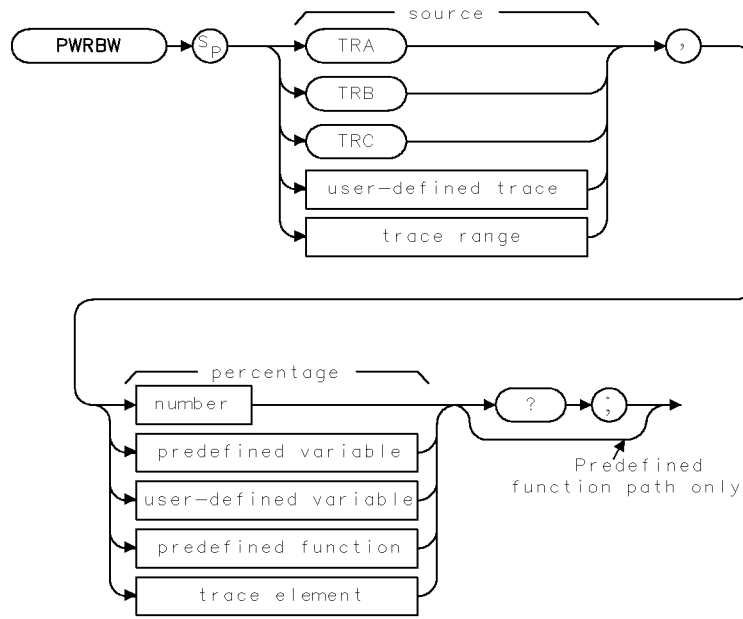

XPWRBW

Item	Description/Default	Range
User-defined trace	A trace defined by the TRDEF command.	Any valid trace name.
Trace range	A segment of trace A, trace B, trace C, or a user-defined trace.	
User-defined variable	A variable defined by VARDEF command.	Any valid variable name.
Predefined variable	A command that acts as a variable. Refer to Table 4-1.	
Predefined function	Function that returns a value. Refer to Table 4-1.	
Trace element	An element of trace A, trace B, trace C, or a user-defined trace.	
Number	Any real or integer number.	0 to 100.

Parameter Values: The field used for the percentage must use a value between 0 and 100.

Prerequisite Commands: TRDEF when using a user-defined trace. VARDEF for a user-defined variable. TS when using trace data.

Related Commands: IFBW, RB, SP

PWRBW Power Bandwidth

Example

OUTPUT 718;"IP;CALSW INT;"	<i>Initializes instrument.</i>
OUTPUT 718;"SNGLS;"	<i>Activates single-sweep mode.</i>
OUTPUT 718;"CF 300MHZ;SP 1MHZ;IFBW 300KHZ;TS;"	<i>Changes center frequency, span, and bandwidth.</i>
OUTPUT 718;"MXMH TRA;TS;TS;TS;TS;"	<i>Activates the maximum hold of trace A, sweep 4 times.</i>
OUTPUT 718;"PWRBW TRA, 99.0;"	<i>Returns the 99% power bandwidth.</i>
ENTER 718;P	<i>Gets the result from the instrument.</i>
DISP "THE POWER BANDWIDTH AT 99 PERCENT IS";P/1.0E+3;"kHz"	<i>Displays the frequency of the power bandwidth specified on the computer screen.</i>

Description

The PWRBW command computes the bandwidth around the trace center, which includes signals whose total power is a specified percentage of the total trace signal power. If trace A is the source, a delta marker is set at the start and stop frequencies.

If 100% is specified, the power bandwidth equals the frequency range of the screen display. If 50% is specified, trace elements are eliminated from either end of the array, until the combined power of the remaining signal responses equals half of the original power computed. The frequency span of these remaining trace elements is the power bandwidth returned.

Query Response

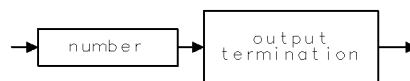

001

PWRUPTIME

Power Up Time

Returns the number of milliseconds that have elapsed since the instrument was turned on.

Syntax



XPWRUPTIME

Example

```
OUTPUT 718;"PWRUPTIME;"
```

Executes PWRUPTIME.

```
ENTER 718;A
```

Places the result of PWRUPTIME into A.

```
A = A/1000
```

Changes the milliseconds to seconds.

```
PRINT "Minutes elapsed ",A/60
```

Prints the number of minutes that have elapsed since the instrument was turned on.

Description

The PWRUPTIME command returns the number of milliseconds that have elapsed since the instrument was turned on. PWRUPTIME can count the number of milliseconds for up to 2^{32} milliseconds (2^{32} milliseconds is equivalent to 49.7 days). If the instrument is left on for more than 49.7 days, PWRUPTIME is reset to 0 and restarts the count.

Query Response

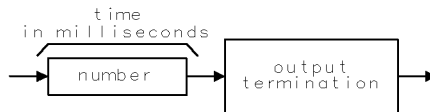

QPWRUPTIME

QPGAIN Quasi-Peak Gain

Turns on or off the linear 10x gain stage in the quasi-peak and average detector signal path.

Syntax

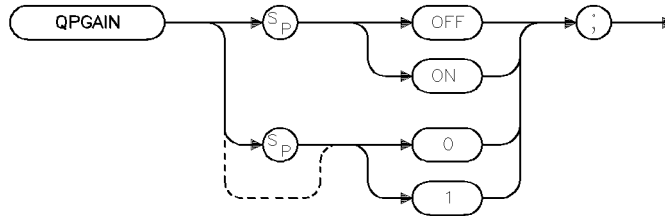

xqpgain

Equivalent Softkey: **QP/AVG 10X OFF**

Preset State: QPGAIN OFF

Example

OUTPUT 718; "QPGAIN ON;"

Description

The QPGAIN command turns on or off the linear 10x gain stage in the quasi-peak and average detector signal path.

RANGE

Range

Puts the highest signal on the display close to the reference level.

Syntax

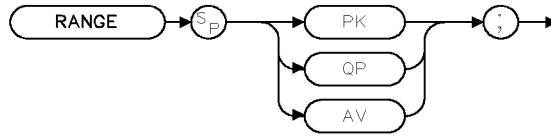

xrange

Related Commands: UNRANGE

Example

```
OUTPUT 718; "RANGE QP;"
```

Description

The RANGE command puts the highest signal on the display close to the reference level. The parameter specifies whether the range is for the peak, quasi-peak, or average detector. For the peak detector, reference level is adjusted until the highest signal over the current frequency range is on the display. For the quasi-peak and average detectors, the quasi-peak/average gain stage is adjusted as necessary. The old reference level is saved away until a matching UNRANGE command is given. RANGE QP and RANGE AV require the detector to be selected and the amplitude scale to be linear.

RB Resolution Bandwidth

Specifies the resolution bandwidth.

Syntax

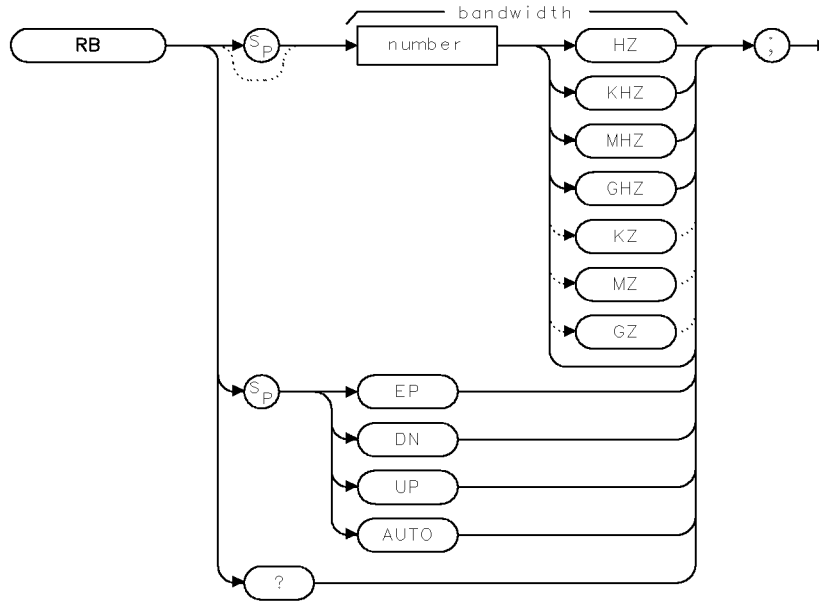

Item	Description/Default	Range
Number	Any real or integer number. Default unit is Hz.	30 Hz to 3 MHz

Equivalent Softkeys: **IF BW AUTO MAN**

Preset State: 3 MHz

Step Increment: 1, 3, 10

Related Commands: AUTO, SP, ST, VB, VBR, IFBW, AVBW

Example

OUTPUT 718;"RB 1KHZ;" *Sets the resolution bandwidth to 1 kHz.*

RB Resolution Bandwidth

Description

The RB command disables the coupling between sweep time and resolution bandwidth. Execute RB AUTO to reestablish coupling. (Also see “AUTO.”)

The 200 Hz, 9 kHz, and 120 kHz 6-dB resolution bandwidths (used for EMI testing) are available by specifying 200 Hz 9 kHz, or 120 kHz as the frequency value; the front-panel knob, step increment keys, and auto-coupled settings provide the 1, 3, 10 resolution bandwidth sequence only. Frequencies are rounded to the nearest value in the 1, 3, 10 sequence if the frequency is other than 200 Hz, 9 kHz, 120 kHz, 5 MHz, or in the 1, 3, 10 sequence.

The instrument provides uncalibrated bandwidths of 10 Hz and 5 MHz.

Query Response

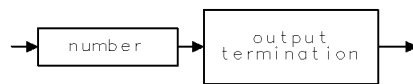

001

RCLC Recall Colors

Recalls previously displayed palettes.

Syntax

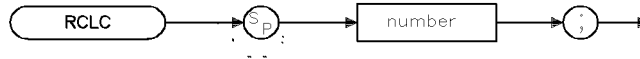

xrclc

Item	Description/Default	Range
Number	Any integer.	0 to 4

Equivalent Softkey: **RECALL COLORS**

Related Commands: SAVEC, SETC

Example

```
OUTPUT 718;"RCLC 1;"
```

Description

The RCLC command recalls previously saved display palettes (the color definitions for the features on the display) from the save/recall register number specified. Any value out of the legal parameter range will generate an error.

Note The legal range of the values for this parameter is between 0 and 4. However, it is strongly advised that you do not use save/recall register 0 since this register is reserved for use by the instrument control firmware.

RCLS

Recall State

Recalls instrument state data from the specified state register.

Syntax

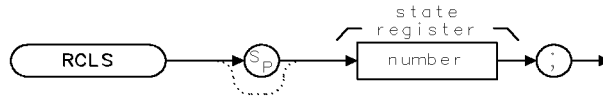

Item	Description/Default	Range
Number	Any real or integer number.	1 to 9

Equivalent Softkeys: **INTERNAL -> STATE**

Related Commands: **LOAD, POWERON, RCLT, SAVES**

Example

```
OUTPUT 718;"IP;CF 300MHZ;SP 1MHZ;" Changes center frequency, span.
OUTPUT 718;"SAVES 3;" Saves state in register 3.
OUTPUT 718;"IP;"
OUTPUT 718;"RCLS 3;" Recalls the contents of register 3.
```

Description

The RCLS command recalls instrument state data from the specified state register in the internal memory. You can specify a state register number from one to nine. Registers one through eight are reserved for your use. Registers one through eight contain instrument state information if instrument state information has been stored in it with the SAVES command. State register nine contains the previous state data.

Note The RCLS recalls state data from internal memory. Refer to “LOAD” to recall state data from the disk file.

RCLT Recall Trace

Recalls previously saved trace data, or limit-line data.

Syntax

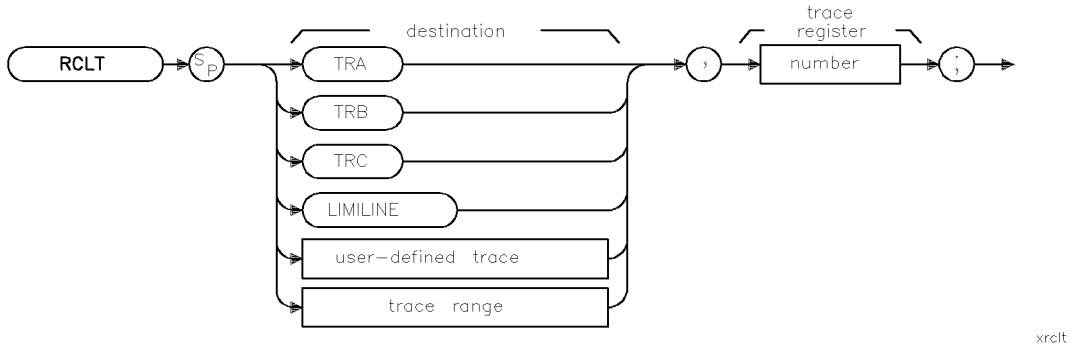

Item	Description/Default	Range
User-defined trace	A trace defined by the TRDEF command.	Any valid trace name.
Trace range	A segment of trace A, trace B, trace C, or a user-defined trace.	0 to TRCMEM - 1.
Number	Any valid integer.	0 to TRCMEM - 1.

Equivalent Softkeys: The RCLT command and the VIEW commands are equivalent to **Internal -> Trace**.

Parameter Value: 0 to TRCMEM - 1

Prerequisite Commands: TRDEF when using a user-defined trace.

Related Commands: CAT, CLRW, LOAD, SAVET, SNGLS, TRCMEM, TS, VIEW

Example

```

10 OUTPUT 718;"IP;CF 300MHZ;SP 20MHZ;TS;" Initializes instrument, changes the center frequency and span.
20 OUTPUT 718;"SAVET TRA,1;" Saves instrument state and trace A data in register 1.
30 OUTPUT 718;"IP;" Initializes instrument.
40 OUTPUT 718;"RCLT TRA,1;VIEW TRA;" Recalls instrument state, trace data; displays the result.
50 END

```

RCLT Recall Trace

Description

The RCLT command recalls previously saved trace data, or limit-line data from the specified trace register in internal memory. Trace data is recalled with instrument state, date, and screen title.

The state and trace data are recalled when the trace destination is trace A, trace B, or trace C. When using a user-defined trace or a trace range for the trace destination, only the trace data is recalled.

When recalling limit-line table data, specify LIMILINE as the destination.

To avoid overwriting the recalled trace data, the VIEW command should be performed immediately after the RCLT command when recalling trace data (see line 40 in the example).

Note	The RCLT recalls trace data from internal memory. Refer to “LOAD” to recall trace data from the disk file.
-------------	--

RCVRRMRKR Receiver Marker Position

Modifies the behavior of the instrument's marker positioning functionality.

Syntax

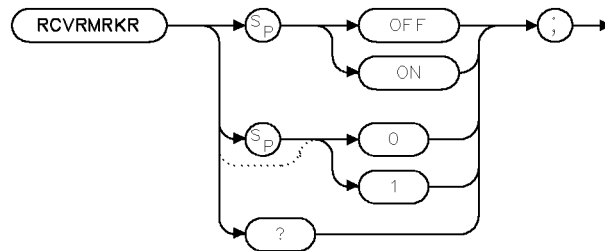

xrcvrmk

Equivalent Softkey: **MARKER TUNE SPN**

Preset State: RCVRRMRKR ON

Related Commands: FASTMRKR, MKN, MKD, MKFC, MKACTION, MKACTV, UP, DN

Example

```
OUTPUT 718; "RCVRRMRKR ON;"
```

Description

The RCVRRMRKR command modifies the behavior of the instrument's marker positioning functionality when accessed through the front-panel numeric keypad, knob, or step-keys.

When RCVRRMRKR is ON:

- Front-panel numeric keypad input, positions frequency and time markers at the specified numeric frequency input, tuning the instrument to the specified frequency if necessary. Numeric key-pad input terminators are "Hz, kHz, MHz, or GHz".
- Knob input, repositions the marker position as a function of frequency, tuning the instrument to its specified frequency if the knob input places the marker position beyond the limits of the current span.
- Step-key input:
 - Zero span, steps the marker to the edge of the display and retunes the instrument on succeeding step-key presses.
 - Non-zero span, positions the marker at the next peak left (DOWN) or next peak right (UP) by one half of the IFBW. If no signals exist, the marker is positioned at the left edge (DOWN) or the right edge (UP) of the display. If the marker is already at the edge of the display, subsequent steps retune the receiver by a step equal to the size of the current span.

RCVRMRKR Receiver Marker Position

When RCVRMRKR is OFF:

- Front-panel key-pad, knob, and step-key inputs, position the marker as appropriate for the marker “type” (frequency, time, and period) within the domain of the instrument’s current span. The instrument is not retuned due to marker positioning input.

Query Response

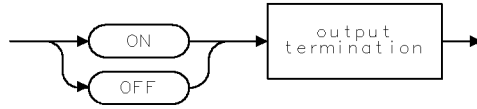

002

REMEASSIG Remeasure Signal

Remeasures one or more signals in the signal list.

Syntax

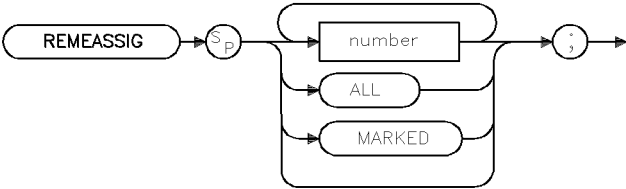

xremsig

Equivalent Softkey: the softkeys accessed by **Re-measure**

Related Commands: AUTOAVG, AUTOQPD, MEASALLSIGS, MEASSIG, MEASTIMEPK, MEASTIMEAVG, MEASTIMEQPD, SIGLIST, SIGMARK, SIGPOS, SIGUNMARK

Example

```

OUTPUT 718;"SIGLIST ON;"
OUTPUT 718;"SIGPOS 3;"
OUTPUT 718;"REMEASSIG;"    Remeasures the third signal in the signal list.

```

Description

The REMEASSIG command remeasures one or more signals in the signal list. If there is no parameter given, the signal at the signal list cursor will be remeasured. A number parameter specifies the signal number to be remeasured. An ALL parameter specifies that all signals in the list will be remeasured. A MARKED parameter specifies that only those signals marked will be remeasured. To remeasure each signal the algorithm spans down on the signal using the initial frequency listed in the table. When zero span is reached, up to three detectors can be used to measure the signal. These detectors are selected using the AUTOAVG and AUOTQPD commands.

REPEAT UNTIL

Repeat Until

Forms a looping construct.

Syntax

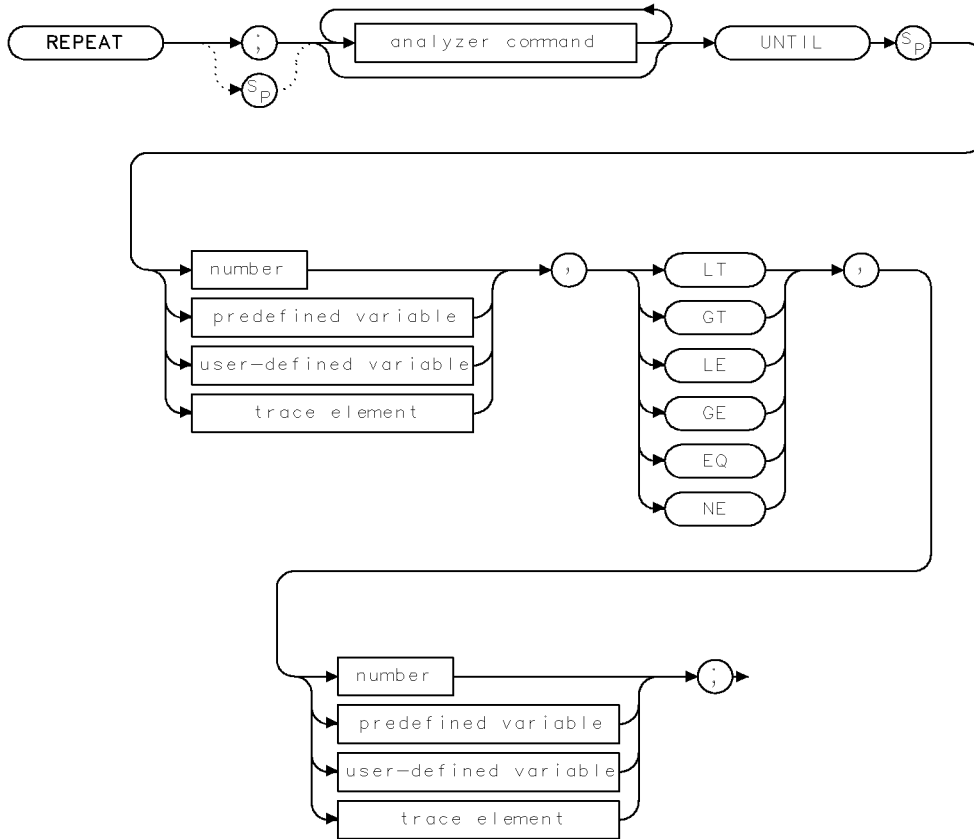

XREPEAT

Item	Description/Default	Range
Instrument command	Any valid complete instrument command.	
User-defined variable	A variable defined by VARDEF command.	Any valid variable name.
Predefined variable	A command that acts as a variable. Refer to Table 4-1.	
Number	Any real or integer number.	Real number range.
Trace element	An element of trace A, trace B, trace C, or a user-defined trace.	

Prerequisite Commands: VARDEF when using a user-defined variable.

Example

The following program lowers any off-screen signal.

10	OUTPUT 718;"IP;"	<i>Initializes instrument.</i>
20	OUTPUT 718;"SNGLS;TS;MKPK HI;"	<i>Activates single-sweep mode, takes sweep, places marker on signal peak.</i>
30	OUTPUT 718;"IF MA,GT,RL THEN;"	<i>Performs lines 40, 50 and 60 if the marker amplitude is greater than the reference level.</i>
40	OUTPUT 718;"REPEAT;"	<i>Increases reference level, takes sweep, places marker on signal peak.</i>
50	OUTPUT 718;"RL UP;TS;MKPK HI;"	<i>Increases reference level, takes sweep, places marker on signal peak.</i>
60	OUTPUT 718;"UNTIL MA,LE,RL;"	<i>Does line 40 until peak amplitude is less than or equal to the reference level.</i>
70	OUTPUT 718;"ENDIF;"	<i>Ends the IF THEN construct.</i>
80	OUTPUT 718;"CONTS;"	
70	END	

Description

The REPEAT UNTIL command form a looping construct. All commands following the REPEAT command are executed until the comparison specified after the UNTIL command is true.

The following are used for comparing the operands:

GT Greater than

LT Less than

LE Less than or equal to

GE Greater than or equal to

EQ Equal to

NE Not equal to

RESETRL

Reset Reference Level

Resets the reference level to the preset level.

Syntax

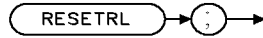

XRESETRL .

Related Commands: AUNITS, IP, ML, RL, RLPOS

Example

```
OUTPUT 718;"RESETRL;"
```

Description

The RESETRL command resets the reference level to the preset level.

REV Revision

Returns the date code of the firmware revision date in YYMMDD format.

Syntax

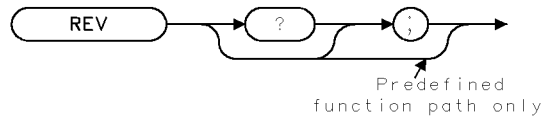

XREV

Equivalent Softkeys: `SHW INST CONFIG`

Related Commands: ID, SER, TIMEDATE

Example

```

OUTPUT 718;"REV;" Gets the firmware revision date of instrument.
ENTER 718;A      Puts the instrument response in the computer variable, A.
DISP A          Displays the firmware revision date on the computer screen.
  
```

Description

The REV command returns the date code of the firmware revision date in YYMMDD format (for example, 931125 indicates 25 November 1993).

The date of the firmware revision also appears when the instrument is first turned on, but it is displayed in the day, month, year format.

Query Response

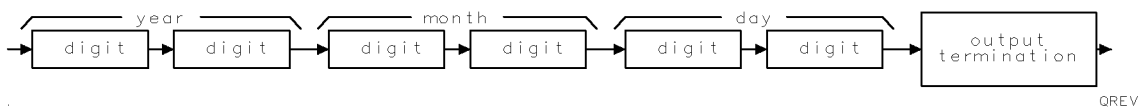

QREV

RFIN

RF Input Signal

Specifies the input signal routing path.

Syntax

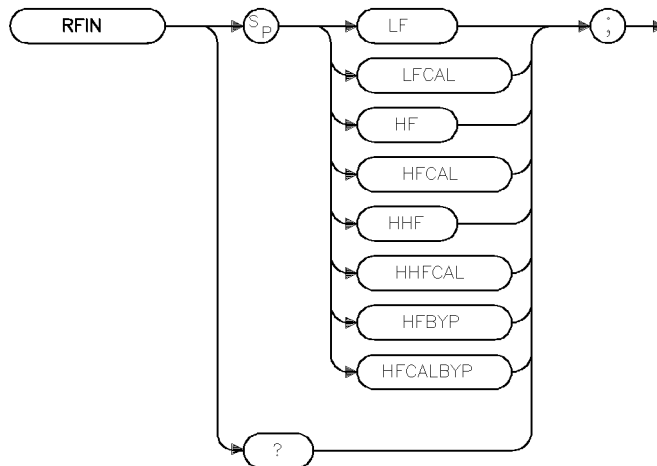

xrfin

Note If the RF filter section is present in the system, and RFINLK is ON, tuning is restricted to the input path currently in effect.

Equivalent Softkey: the softkeys accessed by

Preset Value: HF (INPUT 2 20 MHz to 2.9 GHz)

Related Commands: CALSW, HAVE, RFINLK

Example

```
OUTPUT 718; "RFIN LF:"
```

Description

The RFIN command specifies the input signal routing path through the HP 85420E/HP 85460A RF filter section. Where:

LF indicates the 9 kHz to 50 MHz input path (INPUT 1)

HF indicates the 20 MHz to 2.9 GHz input path (INPUT 2)

BYP indicates the bypass input path (INPUT 2)

CAL indicates the 300 MHz calibrator path is enabled

For an HP 8546A/HP 85462A only.

HHF indicates the 1 GHz to 6.5 GHz input path (INPUT 2)

Query Response

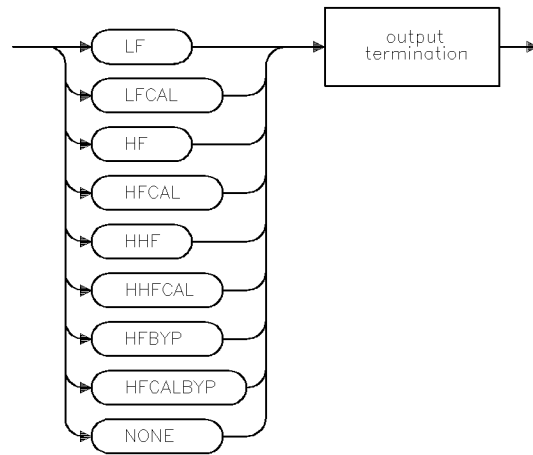

qrfin

Note The parameter NONE is returned if the RF filter section is not present.

RFINLK

RF Input Lock

Limits tuning to values within the currently selected input path.

Syntax

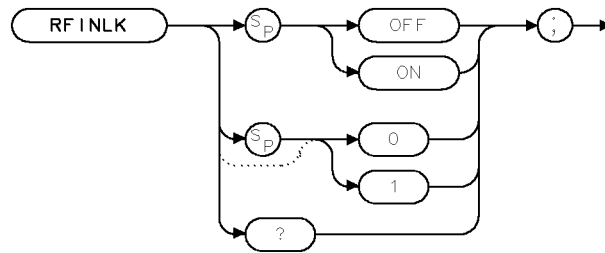

Equivalent Softkey: **INPT LCK ON OFF**

Preset Value: RFINLK ON

Related Commands: RFIN, HAVE

Example

```
10 OUTPUT 718; "RFIN HF;"
20 OUTPUT 718; "RFINLK OFF;"
30 OUTPUT 718; "FA 10MHZ;"
```

Description

The RFINLK command selects if frequency tuning is limited to values within the currently selected input path. For example, if RFINLK is ON, and a stop frequency is selected out of the range of the currently selected input path, the actual stop frequency used will be the highest possible value allowed by the selected input path. This command is only valid when the RF filter section is present.

Query Response

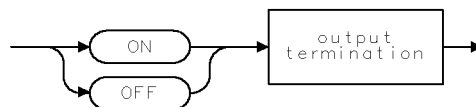

RL Reference Level

Specifies the amplitude value of the reference level.

Syntax

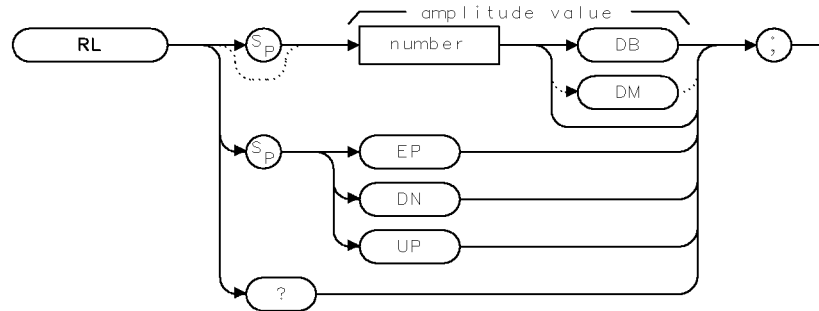

XRL

Item	Description/Default	Range
Number	Any real or integer number. Default unit is the current amplitude unit.	Amplitude range of the instrument.

Equivalent Softkeys:

REF LVL

Preset State:

92 dB μ V (107 dB μ V for an receiver RF section standalone)

Step Increment:

by 10 dB

Related Commands:

AT, MKRL, ML, RESETRL, RLPOS

Example

```

10 OUTPUT 718;"IP;CALSW INT;SNGLS;CF 300MHZ;SP 20MHZ;"
20 OUTPUT 718;"TS;MKPK HI;MKRL;TS;"
30 OUTPUT 718;"RL?;"
40 ENTER 718;Ref_level
50 OUTPUT 718;"AUNITS?;"
60 ENTER 718;A$
70 PRINT "REFERENCE LEVEL IS",Ref_level,A$
80 END

```

Initializes instrument, activates single-sweep mode, changes center frequency, span.

Takes sweep, places marker on signal peak, sets reference level to marker level.

Queries reference level.

Puts the instrument response in the computer variable, Ref_level.

Queries the Amplitude Units

Puts the instrument response in the computer variable, A\$

RL Reference Level

Description

The RL command specifies the amplitude value of the reference level. The reference level and input attenuator are coupled to prevent gain compression. Signals with peaks at or below the reference level are not affected by gain compression.

CAUTION Signal levels above +30 dBm will damage the instrument.

RL may affect the attenuation value.

Query Response

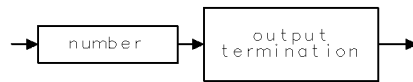

001

RLPOS

Reference-Level Position

Selects the position of the reference level.

Syntax

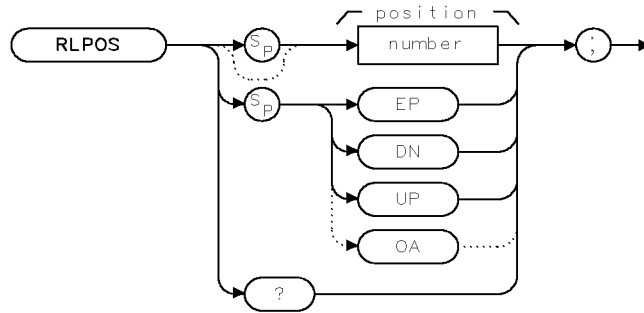

XRLPOS

Item	Description/Default	Range
Number	Any real or integer number.	0 to 8.

Step Increment: 1
 Related Commands: IP, MEASURE, NRL, RL
 Preset State: RLPOS 8

Example

OUTPUT 718;"IP;"	<i>Initializes instrument.</i>
OUTPUT 718;"MEASURE NRM;"	<i>Changes the measurement mode to normalized.</i>
OUTPUT 718;"AMBPL ON;"	<i>Activates trace normalization.</i>
OUTPUT 718;"RLPOS 7;"	<i>Positions the reference level at the seventh major graticule division.</i>

Description

The RLPOS command changes the position of the reference level during log display mode. The top and bottom graticule lines correspond to 8 and 0, respectively. RLPOS must be used with MEASURE NRM or MEASURE SR, and AMBPL ON or AMB ON.

Query Response

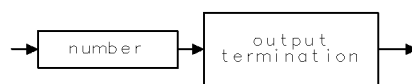

QQ1

RMS

Root Mean Square Value

Returns the root mean square value of the trace in measurement units.

Syntax

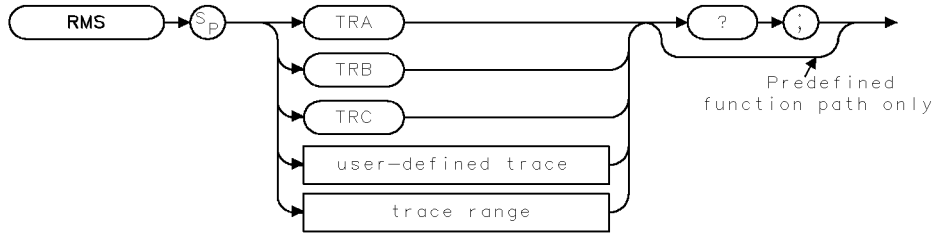

XRMS

Item	Description/Default	Range
User-defined trace	A trace defined by the TRDEF command.	Any valid trace name.
Trace range	A segment of trace A, trace B, trace C, or a user-defined trace.	

Prerequisite Commands: TRDEF when using a user-defined trace. TS when using trace data.

Related Commands: MEAN, PDA, VARIANCE

Example

```

OUTPUT 718;"IP;SNGLS;TS;"
OUTPUT 718;"RMS TRA?;"
ENTER 718;Number
DISP Number
  
```

Description

The RMS command returns the root mean square value of the trace in measurement units. Trace data, user-defined trace data, and trace range data are treated as 16-bit integers.

Query Response

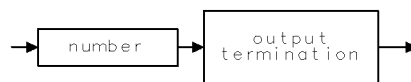

Q01

ROFFSET Reference Level Offset

Offsets all amplitude readouts without affecting the trace.

Syntax

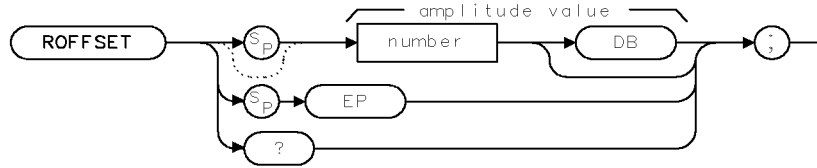

Item	Description/Default	Range
Number	Any real or integer number. Default unit is dB.	-200 dB to +200 dB.

Equivalent Softkeys: **REF LVL OFFSET**

Preset State: 0 dB

Related Commands: AT, RL

Example

```

10 OUTPUT 718;"IP;"           Initializes instrument.
20 OUTPUT 718;"RL 80DB;"     Changes the reference level.
30 OUTPUT 718;"ROFFSET -10;" Changes instrument reference offset value.
40 OUTPUT 718;"RL?;"        Gets the reference value from instrument.
50 ENTER 718;Ref            Puts the instrument response in the computer variable, Ref.

60 DISP "THE NEW REFERENCE LEVEL IS ",Ref Displays 70 as the new reference level.
70 END
    
```

Description

Once activated, the ROFFSET command displays the amplitude offset in the active function block. And, as long as the offset is in effect, the offset is displayed on the left side of the screen.

Entering ROFFSET 0 or presetting the instrument eliminates an amplitude offset.

Query Response

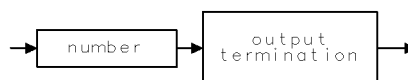

001

RPTDEF

Report Definition

Specifies which report elements are output to a printer or a plotter.

Syntax

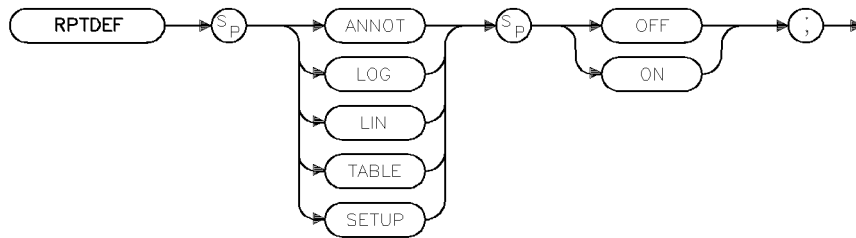

xrptdef

Equivalent Softkey: **Define Report**

Related Commands: TBLDEF

Example

```
10 OUTPUT 718; "RPTDEF ANNOT ON;"
20 OUTPUT 718; "RPTDEF LOG ON;"
30 OUTPUT 718; "RPTDEF SETUP OFF;"
```

Description

The RPTDEF command specifies which elements of a report are output to the printer or the plotter. If any of the elements are set to on, they will be sent to the printer followed by a form feed. The sequence sent is: ANNOT, LOG, LIN, TABLE, SETUP. Only LOG and LIN can be sent to the plotter. The report is generated by **OUTPUT REPORT**.

RQS Service Request Mask

Sets a bit mask for service requests.

Syntax

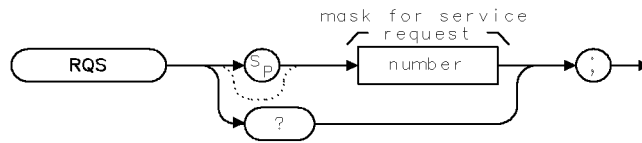

XRQS

Item	Description/Default	Range
Number	Any valid integer.	0 to 63

Related Commands: OVL D, SRQ, STB

Example

OUTPUT 718;"RQS 12;" *Sends a mask bit for hardware broken and end of sweep.*

Description

The RQS command sets a bit mask for service request (see "SRQ"). Assignment of values for the mask is as follows:

- 32 = Illegal command (bit 5)
- 16 = Command complete (bit 4)
- 8 = Hardware broken (bit 3)
- 4 = End of sweep (bit 2)
- 2 = Units key pressed (bit 1)
- 1 = Overload detected (bit 0)

As shown in the example, a mask with hardware broken and end of sweep is equal to 12 (8 + 4). The mask also disables command complete and illegal command interrupts.

To activate all conditions in the mask, the mask value is equal to 63 (32 + 16 + 8 + 4 + 2 + 1). To set the service request mask for all conditions, execute OUTPUT 718;"RQS 63;".

Each bit in the status byte is defined as follows:

- 0** Indicates an overload is detected. SRQ 101 appears on the screen.
- 1** Indicates that the units key was pressed. SRQ 102 appears on the screen. If you activate the units key bit, it will remain active until you activate "EE" and press a units key. (See "EE.")
- 2** Indicates end of sweep. SRQ 104 appears on the screen. If you send any RQS value that contains mask value 4, another sweep will be taken.
- 3** Indicates broken hardware. SRQ 110 appears on the screen.

RQS Service Request Mask

4 Indicates completion of a command. It is triggered by EOI at the end of a command string or the completion of a print or plot.

5 Indicates an illegal instrument command was used. SRQ 140 appears on the screen.

6 and **7** are not used.

The screen numbers 101, 102, 104, and 110 are the octal values corresponding to the status register values; that is, SRQ 102 = bit 6 = octal 100 and bit 2 = octal 2 are both true.

A service request is generated only if the proper request mask bit has been set, and either the condition itself or the Force Service Request (see "SRQ") is sent. To set the request mask, choose the desired interrupt conditions and sum their assigned values. Executing the RQS command with this value sets the bit mask. After setting the bit mask, only the chosen conditions can produce an interrupt. Generally, you must set the bit mask using the RQS command. However, the "hardware broken", "illegal remote command", and "overload detected" conditions are automatically enabled after presetting or sending the IP command. Pressing **PRESET** or sending the IP command, then, produces the same interrupt bit mask as sending "RQS 41;" (decimal 41 is the sum of the assigned values of these three interrupt bits, 32 = Bit 5 and 8 = Bit 3 and 1 = Bit 0).

For most conditions, the RQS mask bit stays set until the next IP or RQS command is executed. When a units key is pressed, the interrupt occurs and the Units Key Pressed bit in the RQS mask is reset. To reenale the Units Key Pressed interrupt, you must send a new RQS mask.

Query Response

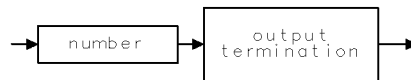

001

SAVEC Save Colors

Saves the currently displayed palette.

Syntax



xsavec

Item	Description/Default	Range
Number	Any integer.	0 to 4

Equivalent Softkey: **SAVE COLORS**

Related Commands: RCLC, SETC

Example

```
OUTPUT 718;"SAVEC 1;"
```

Description

The SAVEC command saves the currently displayed palette (the color definitions for the features on the display) to the save/recall register number specified. Any value out of the legal parameter range will generate an error.

Note The legal range of values for this parameter is between 0 and 4. However, it is strongly advised that you do not use save/recall register 0 since this register is reserved for use by the instrument control firmware.

SAVES

Save State

Saves the currently displayed instrument state in internal memory.

Syntax

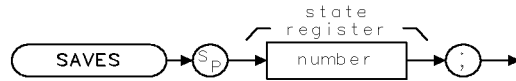

XSAVES

Item	Description/Default	Range
Number	Any valid integer.	1 to 8.

Equivalent Softkeys: `STATE -> INTRNL`

Related Commands: OL, PSTATE, RCLS, SAVET, STOR

Example

OUTPUT 718;"IP;CF 300MHZ;SP 20MHZ;" *Initializes instrument, changes center frequency, span.*

OUTPUT 718;"SAVES 1;" *Saves instrument state in register 1.*

Description

The SAVES command saves the currently displayed instrument state in internal memory. The state data is saved in the specified state register if the state registers have not been locked by the PSTATE command.

Only state registers 1 through 8 are available for saving the instrument state. State register nine contains the previous state data, state register zero contains the current state.

Note The SAVES command saves state data in internal memory. Refer to "STOR" to save state data on a floppy disk.

SAVET Save Trace

Saves the selected trace data and state information or limit-line tables.

Syntax

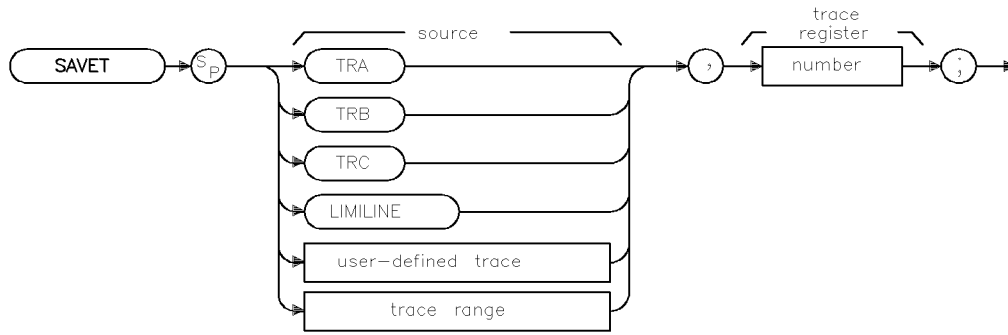

xsavet

Item	Description/Default	Range
User-defined trace	A trace defined by the TRDEF command with a length of 401 elements.	Any valid trace name.
Trace range	A segment of trace A, trace B, trace C, or a user-defined trace.	
Number	Any valid integer.	0 to TRCMEM - 1.

Equivalent Softkeys: `Trace -> Intrnl`

Prerequisite Commands: TRDEF when using a user-defined trace.

Related Commands: CAT, CLRW, PSTATE, RCLT, SNGLS, TS, VIEW

Example

```

OUTPUT 718;"IP;CF 300MHZ;SP 20MHZ;TS;" Initializes instrument, changes the center
frequency and span.

OUTPUT 718;"VIEW TRA;SAVET TRA,1;" Puts trace A in the view mode, saves instru-
ment state and trace A data in register 1.

OUTPUT 718;"IP;" Initializes instrument.
OUTPUT 718;"RCLT TRA,1;VIEW TRA;" Recalls instrument state, trace data.

```

Description

The SAVET command saves the selected trace data and state information, or limit-line tables in internal memory.

The trace data is saved in the specified register if the state registers have not been locked by PSTATE ON (see "SAVES"). Use LIMILINE to save limit-line tables.

SAVET Save Trace

Note The TS and VIEW commands should be executed prior to saving trace data.

The SAVET command saves trace data or limit-line tables in internal memory. Refer to “STOR” to save data on a floppy disk.

SEGDEL Segment Delete

Deletes the specified segment from the limit-line tables.

Syntax

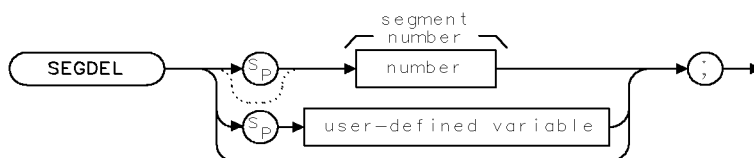

XSEGDEL

Related Commands: LIMIAMPSCL, LIMIDEL, LIMIDISP, LIMIFAIL, LIMIFRQSCL, LIMIFT, LIMIH, LIMILINE, LIMILINESTA, LIMILO, LIMIMARGAMP, LIMIMARGSTA, LIMIMIRROR, LIMIMODE, LIMINUM, LIMIREL, LIMISEG, LIMISEGT, LIMITEST, SENTER, SENTERT

Example

EMI receiver mode only

This example uses LIMISEG for entering segments into limit 1 table, then entering a segment into limit 2 table (limit 1 and limit 2 are treated as separate tables). Line 80 demonstrates the effect of deleting segment 1 from limit 1 table when limit 1 and limit 2 tables are treated separately.

10 OUTPUT 718;"LIMINUM LIMIT1;"	<i>Specifies limit 1 table.</i>
20 OUTPUT 718;"LIMIDEL;"	<i>Deletes limit 1 table.</i>
30 OUTPUT 718;"LIMISEG 300MHZ,-30DB,FLAT;"	<i>Enters segment into limit 1 table.</i>
40 OUTPUT 718;"LIMINUM LIMIT2;"	<i>Specifies limit 2 table.</i>
50 OUTPUT 718;"LIMIDEL;"	<i>Deletes limit 2 table.</i>
60 OUTPUT 718;"LIMISEG 300MHZ,-40DB,FLAT;"	<i>Enters segment into limit 2 table.</i>
70 OUTPUT 718;"LIMINUM LIMIT1;"	<i>Specifies limit 1 table.</i>
80 OUTPUT 718;"SEGDEL 1;"	<i>Deletes segment 1 from limit 1 table.</i>
90 END	

Signal analysis mode only

This example uses LIMISEG for entering segments into the upper limit-line table, then entering a segment into the lower limit-line table (upper and lower limit lines are treated as separate tables). Line 70 demonstrates the effect of deleting segment 1 from the lower limit table when the upper and lower limit-line tables are treated separately.

10 OUTPUT 718;"LIMIMODE UPPER;"	<i>Specifies the upper limit-line table.</i>
20 OUTPUT 718;"LIMIDEL;"	<i>Deletes the upper limit-line tables.</i>
30 OUTPUT 718;"LIMIFT FREQ;"	<i>Limit lines to be based on frequency.</i>
40 OUTPUT 718;"LIMISEG 300MHZ,-30DB,FLAT;"	<i>Enters a segment into the upper limit-line table.</i>
50 OUTPUT 718;"LIMIMODE LOWER;"	<i>Specifies the lower limit-line table.</i>
60 OUTPUT 718;"LIMIDEL;"	<i>Deletes the lower limit-line table.</i>
70 OUTPUT 718;"LIMISEG 300MHZ,-70DB,FLAT;"	<i>Enters a segment into the lower limit-line table.</i>

SEGDEL Segment Delete

```
80 OUTPUT 718;"SEGDEL 1;"
```

Deletes the segment from the lower limit-line table.

```
90 END
```

Signal analysis mode only

With the addition of line 80, the upper and lower limit-line tables are no longer treated as separate tables, but as one table. In line 90, segment 1 is deleted from the upper and lower limit-line tables (for the given frequency).

```
10 OUTPUT 718;"LIMIMODE UPPER;"
```

Specifies the upper limit-line table.

```
20 OUTPUT 718;"LIMIDEL;"
```

Deletes deletes both the upper and lower limit-line table.

```
30 OUTPUT 718;"LIMI FT FREQ;"
```

Limit lines to be based on frequency.

```
40 OUTPUT 718;"LIMISEG 300MHZ,-30DB,FLAT;"
```

Enters segment into the upper limit-line table.

```
50 OUTPUT 718;"LIMIMODE LOWER;"
```

Specifies the lower limit-line table.

```
60 OUTPUT 718;"LIMIDEL;"
```

Deletes the lower limit-line table.

```
70 OUTPUT 718;"LIMISEG 300MHZ,-70DB,FLAT;"
```

Enters a segment into the lower limit-line table.

```
80 OUTPUT 718;"LIMIMODE UPLOW;"
```

Specifies both the upper and lower limit-line tables.

```
90 OUTPUT 718;"SEGDEL 1;"
```

Deletes the segment from both the upper and lower limit-line tables.

```
100 END
```

Description

The result of SEGDEL depends on the setting of the LIMIMODE command as shown in the following table.

LIMIMODE Setting	Result of SEGDEL
LIMIMODE UPPER	Deletes specified segment from the upper limit-line table.
LIMIMODE LOWER	Deletes specified segment from the lower limit-line table.
LIMIMODE UPLOW	Deletes specified segment from the upper and lower limit-line table.
LIMIMODE DELTA	Deletes specified segment from the mid and delta limit-line table.

You may want to query LIMIMODE before using SEGDEL if you are unsure of the LIMIMODE setting.

To determine the number of each segment, you can use the softkeys accessed by **Edit Limit** to display the limit-line table. (Limit-line entries are sorted according to frequency or time.)

SENDER Segment Entry for Frequency Limit Lines

Enters the limit-line data in the upper and lower limit-line table.

Note Signal analysis mode only.

Syntax

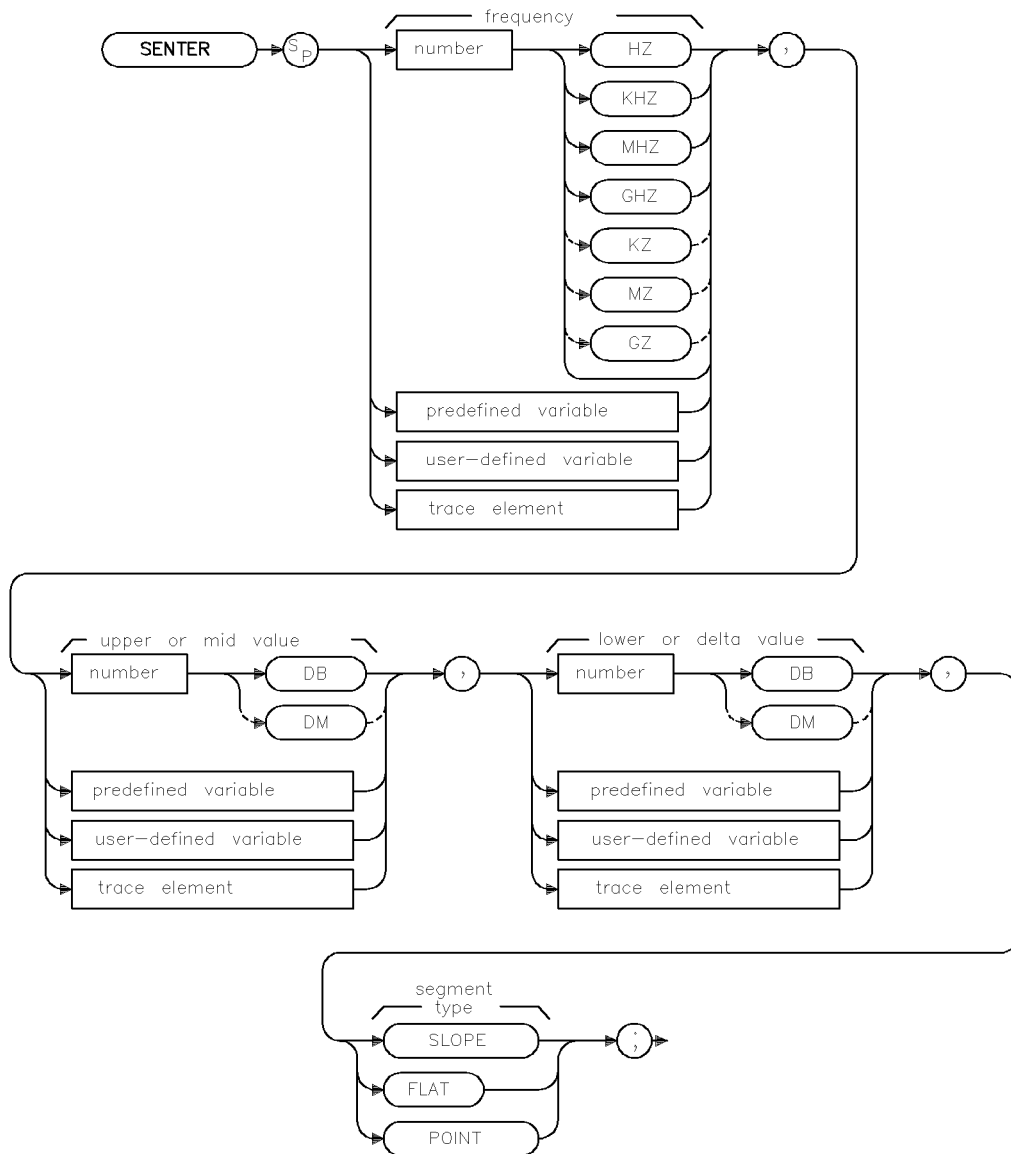

xsender

SENDER Segment Entry for Frequency Limit Lines

Item	Description/Default	Range
Number	Any real or integer number. Default unit is dBm.	Varies with FOFFSET and ROFFSET.
User-defined variable	A variable defined by VARDEF command.	Any valid variable name.
Predefined variable	A command that acts as a variable. Refer to Table 4-1.	
Trace element	An element of trace A, trace B, trace C, or a user-defined trace.	

Related Commands: LIMIAMPSCL, LIMIDEL, LIMIDISP, LIMIFAIL, LIMIFRQSCL, LIMIFT, LIMIMIHI, LIMILINE, LIMILO, LIMIMIRROR, LIMIMODE, LIMIREL, LIMISEG, LIMISEGT, LIMITEST, SEGDEL, SENTERT

Example

This example enters limit-line values into the upper and lower limit-line tables.

10 OUTPUT 718;"LIMIFT FREQ;"	<i>Sets the limit lines to be based on frequency and deletes any existing tables.</i>
20 OUTPUT 718;"LIMIMODE UPLOW;LIMIREL OFF;"	<i>Specifies the upper and lower limit-line table as fixed.</i>
30 OUTPUT 718;"SENDER 300MHZ,-10DB,-50DB,FLAT;"	<i>Enters in values for a segment.</i>
40 OUTPUT 718;"SENDER 350MHZ,-15DB,-60DB,FLAT;"	<i>Enters in values for another segment.</i>
50 OUTPUT 718;"LIMIFT FREQ;"	<i>Sets the limit lines to be based on frequency and deletes any existing tables.</i>
60 OUTPUT 718;"LIMIMODE DELTA;LIMIREL OFF;"	<i>Specifies the mid and delta table format and fixed type.</i>
70 OUTPUT 718;"SENDER 300MHZ,-20DB,10DB,FLAT;"	<i>Enters in values for a segment.</i>
80 OUTPUT 718;"SENDER 350MHZ,-30DB,20DB,FLAT;"	<i>Enters in values for another segment.</i>
90 END	

Description

The SENDER command enters the limit-line data in the upper and lower limit-line table or the mid and delta table for limit lines based on frequency.

Each limit-line segment is specified with a starting frequency, an upper or median amplitude value, a lower or delta amplitude value, and a segment type. The segment type defines how the line segment is to extend from its starting point to the next segment.

Note If the current limit-line table contains lines based on sweep time (as opposed to a limit-line based on the frequency), executing SENDER will clear the current sweep time limit line table.

The three segment types are FLAT, SLOPE, and POINT.

- FLAT draws a zero-slope line between the coordinate point of the current segment and the coordinate point of the next segment, producing limit-line values equal in amplitude for all frequencies between the two points. If the amplitude values of the two segments differ, the limit-line will “step” to the value of the second segment.

SENDER Segment Entry for Frequency Limit Lines

- SLOPE draws a straight line between the coordinate point of the current segment and the coordinate point of the next segment, producing limit-line values for all frequencies between the two points.
- POINT specifies a limit value for the coordinate point, and no other frequency points, so that a POINT segment specifies a limit value for a single frequency. The POINT segment type may be used as the last segment in the limit-line table. However, if the last segment in the table is not specified as the POINT segment type, an implicit point is automatically used. If a visible POINT segment at the right-hand edge of the display is not desired, add an explicit last point segment to the limit-line table that is higher in frequency than the stop frequency.

Segments are sorted as they are entered according to frequency. A maximum of 30 segments can be defined using SENTER.

SENTERT

Segment Entry for Sweep Time Limit Lines

Enters the limit-line data in either the upper and lower limit-line table.

Note Signal analysis mode only.

Syntax

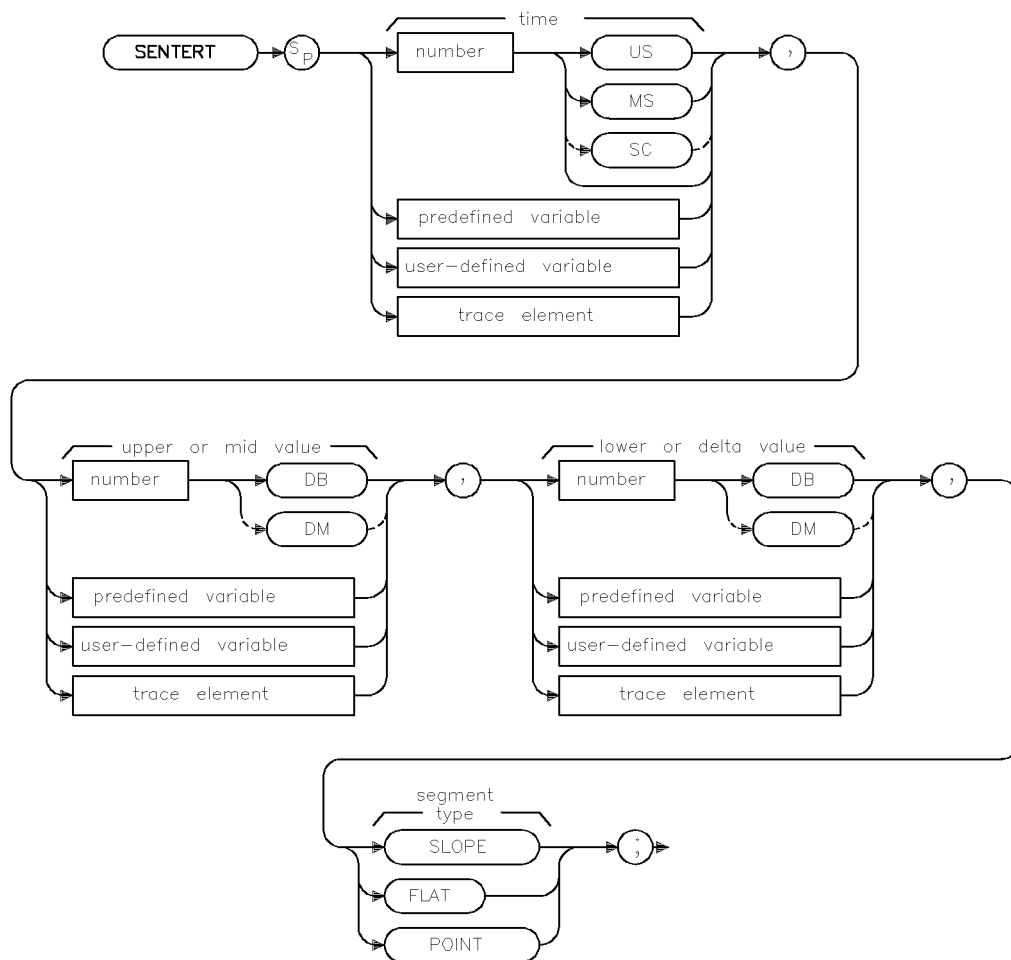

xsentert

SENTERT Segment Entry for Sweep Time Limit Lines

Item	Description/Default	Range
Number	Any real or integer number. For amplitude, the default unit is dBm. For sweep time, the default unit is seconds.	The range for the amplitude varies with ROFFSET. The range for the sweep time is the sweep time range of the instrument.
User-defined variable	A variable defined by VARDEF command.	Any valid variable name.
Predefined variable	A command that acts as a variable. Refer to Table 4-1.	
Trace element	An element of trace A, trace B, trace C, or a user-defined trace.	

Related Commands: LIMIAMPSCL, LIMIDEL, LIMIDISP, LIMIFAIL, LIMIFRQSCL, LIMIFT, LIMIMI, LIMILINE, LIMILO, LIMIMIRROR, LIMIMODE, LIMIREL, LIMISEG, LIMISEGT, LIMITEST, SEGDEL, SENTER

Example 1

This example enters limit-line values into the upper and lower limit-line tables.

10 OUTPUT 718;"RL -10DB;"	<i>Sets the reference level to -10 dB.</i>
20 OUTPUT 718;"LIMIFT TIME;"	<i>Sets the limit lines to be based on sweep time and deletes any existing tables.</i>
30 OUTPUT 718;"LIMIMODE UPLOW;LIMIREL ON;"	<i>Specifies the upper and lower limit-line table as relative.</i>
40 OUTPUT 718;"SENTERT 10MS,-10DB,-50DB,FLAT;"	<i>Enters in values for a segment.</i>
50 OUTPUT 718;"SENTERT 0MS,-15DB,-60DB,FLAT;"	<i>Enters in values for a segment.</i>
60 OUTPUT 718;"LIMITEST ON;TS;"	<i>Turns on the limit-line testing.</i>
70 END	

Example 2

10 OUTPUT 718;"LIMIFT TIME;"	<i>Sets the limit lines to be based on sweep time and deletes any existing tables.</i>
20 OUTPUT 718;"LIMIMODE DELTA;LIMIREL OFF;"	<i>Specifies the mid and delta table format and fixed type.</i>
30 OUTPUT 718;"SENTERT 10MS,-20DB,10DB,FLAT;"	<i>Enters in values for a segment.</i>
40 OUTPUT 718;"SENTERT 0MS,-30DB,20DB,FLAT;"	<i>Enters in values for a segment.</i>
50 OUTPUT 718;"LIMITEST ON;TS"	<i>Turns on the limit-line testing.</i>
60 END	

Description

The SENTERT command enters the limit-line data in either the upper and lower limit-line table or the mid and delta table for limit lines based on sweep time.

Each limit-line segment is specified with a starting sweep time, an upper or median amplitude value, a lower or delta amplitude value, and a segment type. The segment type defines how the line segment is to extend from its starting point to the next segment.

SENTERT Segment Entry for Sweep Time Limit Lines

Note If the current limit-line table contains lines based on frequency (as opposed to a limit-line based on the sweep time), executing SENTERT will clear the current frequency limit line table.

The three segment types are FLAT, SLOPE, and POINT.

- FLAT draws a zero-slope line between the coordinate point of the current segment and the coordinate point of the next segment, producing limit-line values equal in amplitude for all sweep times between the two points. If the amplitude values of the two segments differ, the limit-line will “step” to the value of the second segment.
- SLOPE draws a straight line between the coordinate point of the current segment and the coordinate point of the next segment, producing limit-line values for all sweep times between the two points.
- POINT specifies a limit value for the coordinate point, and no other sweep time points, so that a POINT segment specifies a limit value for a single sweep time. The POINT segment type may be used as the last segment in the limit-line table. However, if the last segment in the table is not specified as the POINT segment type, an implicit point is automatically used. If a visible POINT segment at the right-hand edge of the display is not desired, add an explicit last point segment to the limit-line table that is higher in sweep time than the current sweep time of the instrument.

Segments are sorted as they are entered according to starting sweep time. A maximum of 30 segments can be defined using SENTERT.

SER Serial Number

Returns the serial number suffix of the instrument.

Syntax

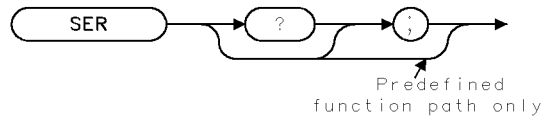

XSER

Equivalent Softkey: `SHW INST CONFIG`

Related Commands: ID, REV

Example

```

DIM Serial$[24]   Reserves memory space for a string.
OUTPUT 718;"SER;" Gets the serial number from the instrument.
ENTER 718;Serial$ Puts the instrument response in the computer variable.
DISP Serial$     Displays the serial number on the computer screen.
  
```

Description

The SER command returns the serial number suffix of the instrument.

Query Response

The last five digits of the serial number are returned.

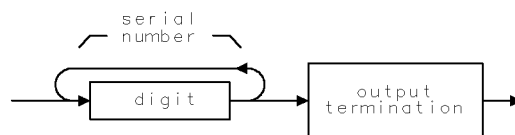

QSER

SETC

Set Colors

Displays the subsystem's color editor.

Syntax

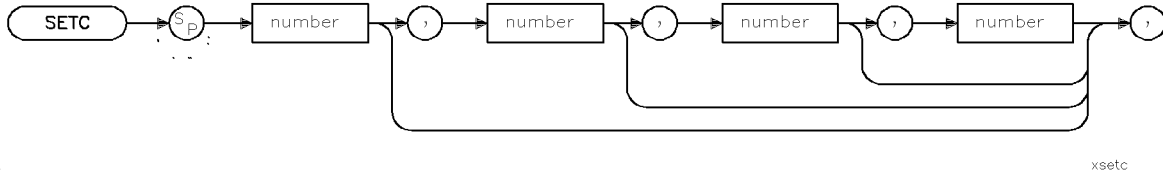

Item	Description/Default	Range
Number	Integer	-5 to 0
Number	Integer	0 to 16

Equivalent Softkey: the softkeys accessed by **Adjust Color**

Related Commands: RCLC, SAVEC

Example 1

10 OUTPUT 718;"SETC -1;" *Sets the current palette to default palette.*

Example 2

10 OUTPUT 718;"SETC 4, ,50,75;" *Sets the HSL values for Trace C to Hue = 0, Saturation = 50, and Luminosity = 75.*

Description

The SETC command provides a limited remote interface to the display subsystem's color editor. If the first parameter selected for the SETC command is a positive value, it is interpreted as the display item number to be edited. The next three optional parameter values are interpreted as hue, saturation, and luminosity values, respectively, to set for the selected display item. The parameters for the associated items are defined in the integer index below:

- 0 = Background
- 1 = Graticule
- 2 = Trace A
- 3 = Trace B
- 4 = Trace C
- 5 = Limit line 1
- 6 = Active function
- 7 = Annotation

8 = Advisories

9 = Errors

10 = Markers

11 = Softkey labels

12 = Status

13, 14, and 15 are reserved

The three optional parameter values have a range of 0 to 100 (0 to 99 for hue, the first parameter). If you do not select a value for any of the optional parameters, the associated parameter will be set to zero.

Note Values greater than 16 for the first parameter of the SETC command are evaluated using modulo 16 (see MOD command for more information). For example, a value of 18 is equivalent to 2.

If the first parameter supplied to the SETC command is a negative number, the second, third, and fourth optional parameters are ignored. The display palette is set to one of the standard palettes. The associated palettes are defined in the index below:

-1 = Default pallet

-2 = Monochrome pallet

-3 = Vision enhance 1 pallet

-4 = Vision enhance 2 pallet

-5 = Optical filter pallet

SETDATE

Set Date

Sets the date of the real-time clock of the instrument.

Syntax

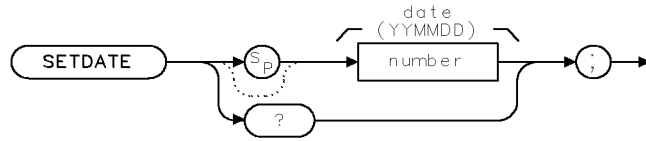

XSETDATE .

Item	Description/Default	Range
Number	A number in the YYMMDD format.	Valid year, month, and day.

Equivalent Softkeys: **SET DATE**

Related Commands: SETTIME, TIMEDATE, TIMEDSP

Example

OUTPUT 718; "SETDATE 890212;" *Sets the date to February 12, 1989.*

Description

The SETDATE command sets the date of the real-time clock of the instrument.

Query Response

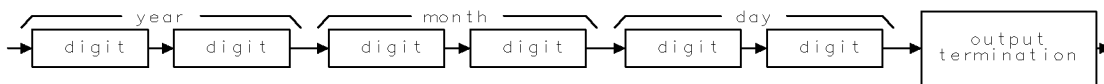

QSETDATE .

SETTIME

Set Time

Sets the time of the real-time clock of the instrument.

Syntax

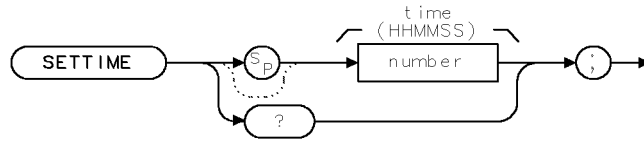

XSETTIME .

Item	Description/Default	Range
Number	A number in the HHMMSS (24 hour) format.	0 to 235959.

Equivalent Softkeys: **SET TIME**

Related Commands: SETDATE, TIMEDATE, TIMEDSP

Example

OUTPUT 718;"SETTIME 135501;" *Sets the time to 1:55:01 PM.*

Description

The SETTIME command sets the time of the real-time clock of the instrument.

Note Trailing zero's are required when setting the real-time clock. For example, to set the clock to 12:00, enter 120000, entering 1200, will set the time to 00:12.
Leading zero's are not required.

Query Response

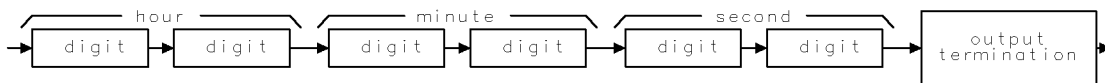

OSETTIME .

SHOWSETUP

Show Set Up

Shows the setup on the display.

Syntax

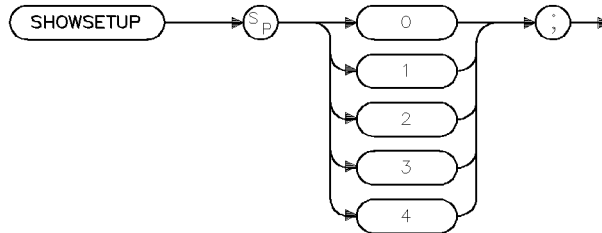

xsetup

Item	Description/Default	Range
Number	Any integer.	0 to 4

Equivalent Softkey: **SHOW SETUP**

Preset State: 0 OFF

Example

OUTPUT 718; "SHOWSETUP 1;"

Description

The SHOWSETUP command shows the current settings of the instrument on the display. This includes existing filenames, correction-factor data, limi-line data, frequency settings, trace data, and so on. SHOWSETUP consists of four pages of information. SHOWSETUP 1 displays the first page, SHOWSETUP 2 displays the second page, and so on. A SHOWSETUP of 0 turns the setup display OFF.

SIGADD Signal Add

Adds a signal to the internal signal list.

Syntax

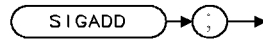

xsigadd .

Equivalent Softkey: **ADD TO LIST**

Prerequisite Commands: MEASAVG, MEASSIG, MEASFREQ, MEASQPD, MEASPEAK

Related Commands: MEASALLSIGS, MEASAVG, MEASFREQ, MEASPEAK, MEASQPD, MEASSIG, REMEASSIG, SIGDEL, SIGLIST

Example

```

OUTPUT 718; "MEASSIG;"
OUTPUT 718; "SIGADD;"
  
```

Description

The SIGADD command adds a signal to the internal signal list. The signal must have been previously measured using the MEASAVG, MEASSIG, MEASFREQ, MEASQPD, or MEASPEAK commands.

SIGDEL

Signal Delete

Deletes one or more signal from the signal list.

Syntax

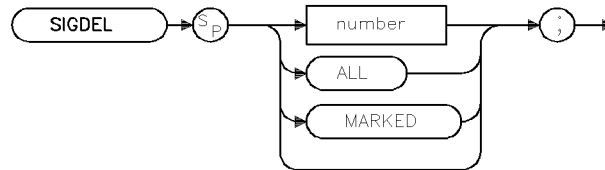

xsigdel

Equivalent Softkey: the softkeys accessed by **Delete Signals**

Related Commands: MEASALLSIGS, MEASSIG, SIGADD

Example

```
OUTPUT 718;"SIGDEL 5;"
```

Description

The SIGDEL command deletes one or more signals from the signal list. If there is no parameter given, the signal at the cursor will be deleted. An integer parameter specifies a signal number to delete from the list. An ALL parameter deletes all signals from the list. A MARKED parameter deletes only those signals that are marked from the list.

SIGDLTAVIEW Signal Delta View

Selects which delta from limit is viewed on the display signal list.

Syntax

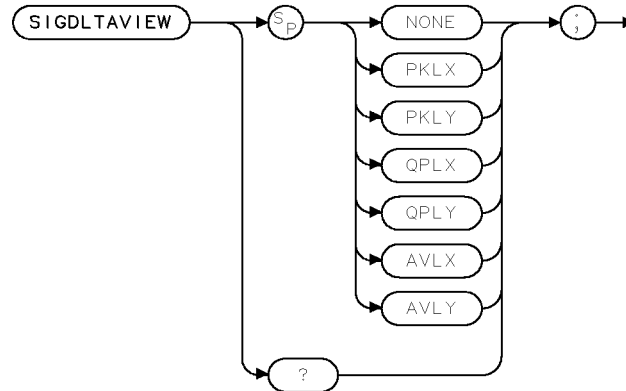

xsigdvw

Equivalent Softkey: the softkeys accessed by `VIEW Δ OFF`

Related Commands: SIGLIST, SIGSORT

Example

```
OUTPUT 718; "SIGDLTAVIEW AVLX;"
```

Description

The SIGDLTAVIEW command selects which delta from the limit-line table is viewed by the display signal list. The choices are:

```
VIEW PK
peak to limit 1 (PKLX), ΔLIM 1
```

```
VIEW PK
peak to limit 2 (PKLY), ΔLIM 2
```

```
VIEW QP
quasi-peak to limit 1 (QPLX), ΔLIM 1
```

```
VIEW QP
quasi-peak to limit 2 (QPLY), ΔLIM 2
```

```
VIEW AVG
average to limit 1 (AVLX), ΔLIM 1
```

```
VIEW AVG
average to limit 2 (AVLY), ΔLIM 2
```

SIGDLTAVIEW Signal Delta View

The viewing from delta to limit can also be turned off (NONE).

Note If there is no data recorded for the signal, verify that the limit is defined and turned on, the frequency in the limit-line table is defined at the signal frequency, and the selected detector has been measured.

Query Response

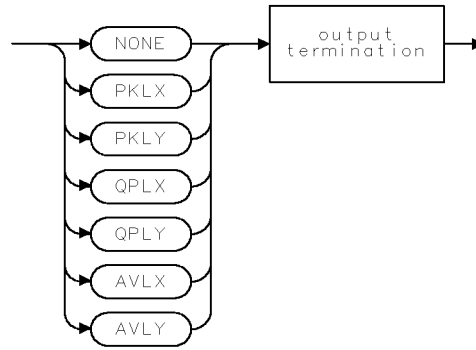

qsigdvw .

SIGGRAPH Signal Graph

Draws an EMI report graph on the display.

Syntax

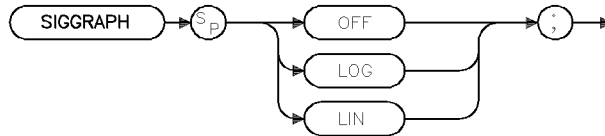

xsiggrp

Equivalent Softkey: `SAVE LOG GRAPH` and `SAVE LIN GRAPH`

Preset State: `SIGGRAPH OFF`

Related Commands: `SIGLIST`, `REPORT`

Example

```
OUTPUT 718; "SIGGRAPH LIN;"
```

Description

The SIGGRAPH command draws an EMI report graph on the display. The graph can either be on a logarithmic or a linear scale.

SIGGRAPH LOG or LIN draws a full screen graticule, either logarithmic or linear frequency axis with limited annotation. On the graticule, drop lines for peak amplitude signals with cross-bars for quasi-peak and average amplitude readings are drawn. The quasi-peak cross-bar is the same color as Trace B (default is blue) and the average cross-bar is the same color as Trace C (default is magenta). The start and stop frequencies are defined based on the frequencies in the signal list.

SIGLEN

Signal List Length

Queries the current number of signals in the signal list.

Syntax

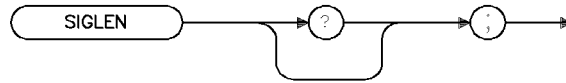

xsiglen

Related Commands: SIGLIST, SIGPOS, SIGRESULT

Item	Description/Default	Range
Number	Any real number	0 to 240

Example

```
OUTPUT 718; "SIGLEN?;"  
ENTER 718; Length
```

Description

The SIGLEN command queries the current number of signals in the signal list.

Query Response

The query returns an ASCII numeric corresponding to the position of the cursor in the signal list.

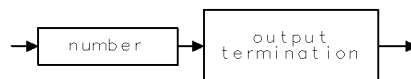

001

SIGLIST Signal List

Turns on or off the signal list viewing and editing functions.

Syntax

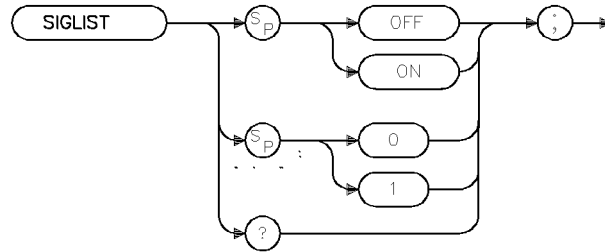

xsiglst

Equivalent Softkey: **SIG LIST ON OFF**

Preset Value: SIGLIST OFF

Related Commands: MEASALLSIGS, MEASSIG, REMEASSIG, SIGDEL, SIGLIST, SIGMARK, SIGUNMARK, SIGDLTVIEW, SIGADD

Example

```
10 OUTPUT 718; "SIGLIST ON;"
```

Description

The SIGLIST command turns on or off the signal list viewing and editing functions.

Query Response

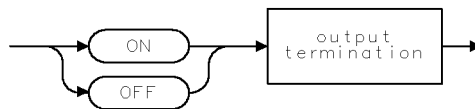

002

SIGMARK

Signal Mark

Marks one or more signals on the signal list.

Syntax

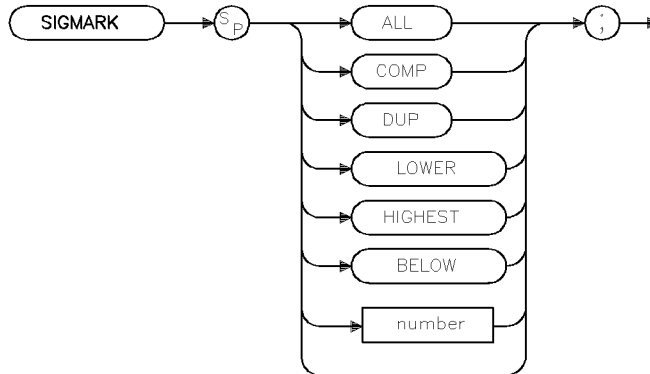

xsigmrk

Equivalent Softkey: the softkeys accessed by **Signal Marking**

Related Commands: SIGUNMARK, SIGPOS

Example

```
OUTPUT 718; "SIGMARK LOWER;"
```

Description

The SIGMARK command marks one or more signals on the signal list. If there is no parameter specified, the signal at the cursor will be marked (see SIGPOS command). An integer parameter specifies a signal number in the list to be marked. An ALL parameter specifies all signals in the list will be marked. A COMP parameter compliments all marked signals in the list. A DUP parameter marks all signals that are duplicated in the list. A LOWER parameter marks all duplicate signals in the list that are lower in peak amplitude. A HIGHEST parameter marks the ten highest signals in the list. A BELOW parameter marks all signals below the signal currently pointed to in the signal list.

SIGPOS Signal Position

Controls and queries the cursor position in the signal list.

Syntax

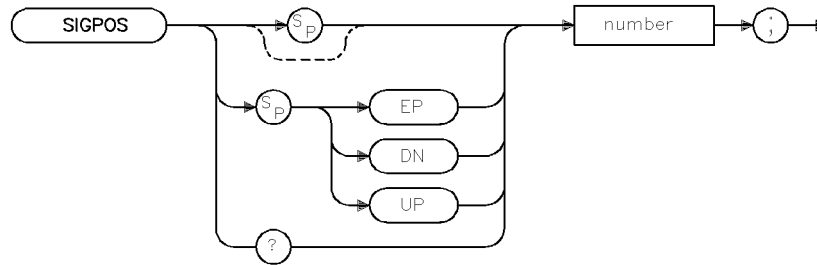

xsigpos

Controls and queries the cursor position in the signal list.

- Preset State: 1
- Related Commands: SIGRESULT, SIGLIST, SIGLEN
- Related Softkey: **SELECT FRM LIST**

Item	Description/Default	Range
Number	Any real number	0 to 240

Example

OUTPUT 718; "SIGPOS 5;"

Description

The SIGPOS command controls and queries the cursor position in the signal list.

Query Response

The query returns an ASCII numeric corresponding to the position of the cursor in the list.

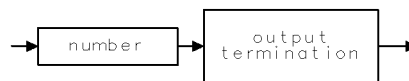

QQ1

SIGRESULT

Signal Result

Sends the contents of an entry in the signal list to the controller.

Syntax

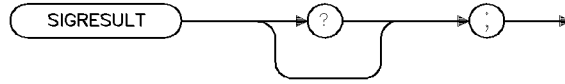

xsigres

Related Commands: MEASALLSIGS, MEASSIG, REMEASSIG, SIGADD, SIGDEL, SIGLEN, SIGLIST, SIGMARK, SIGUNMARK

Example

```

10 DIM Result$ [140]
20 OUTPUT 718; "SIGLEN;"
30 ENTER 718;Ssize
40 OUTPUT 718; "SIGPOS 1;"
50 FOR I=1 to Ssize
60 OUTPUT 718; "SIGRESULT;"
70 ENTER 718;Result$
80 PRINT Result$
90 OUTPUT 718; "DN;"           !Moves down the list
100 NEXT I

```

Description

The SIGRESULT command sends the contents of an entry in the signal list to the controller. The signal entry which is sent is determined by first issuing the SIGPOS command. If the signal list is empty or the SIGPOS is outside the range of the signals within the list, an ASCII NULL with EOI asserted

Query Response

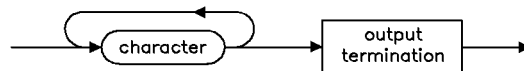

qq4

SIGSORT Signal Sort

Sorts the internal signal list based on the field selected by the parameter.

Syntax

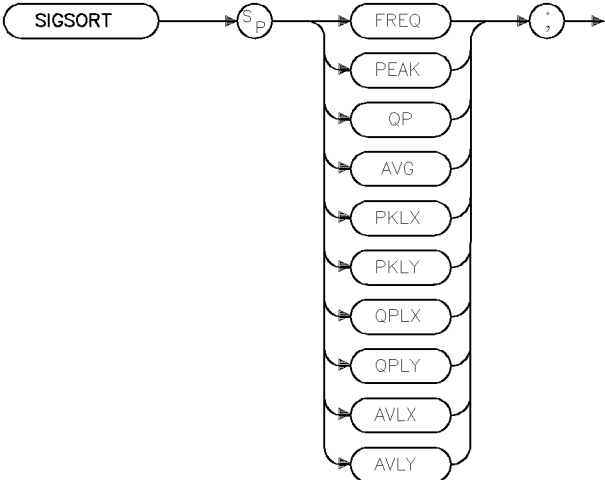

xsigsrt

Equivalent Softkey: the softkeys accessed by **Sort Signals**

Related Commands: SIGLIST, SIGDLTAVIEW

Example

```
OUTPUT 718; "SIGSORT PKLX;"
```

Description

The SIGSORT command sorts the internal signal list based on the field selected by the parameter. The fields to chose from are:

the frequency of the signals (FREQ), **SORT BY** FREQ

the peak amplitude (PEAK), **SORT BY** PK AMP

the quasi-peak amplitude (QP), **SORT BY** QP AMP

the average amplitude (AVG), **SORT BY** AVG AMP

the peak delta from limit 1 (PKLX)

the peak delta from limit 2 (PLKY)

SIGSORT Signal Sort

the qp delta from limit 1 (QPLX)

the qp delta from limit 2 (QPLY)

the average delta from limit 1 (AVLX)

the average delta from limit 2 (AVLY)

For the **FREQ** parameter, the list will be sorted in ascending order. For all other parameters, the list will be sorted in descending order.

SIGUNMARK Signal Unmark

Unmarks one or more signals on the signal list.

Syntax

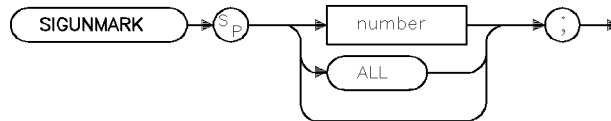

xsunmrk

Equivalent Softkey: `CLEAR MARK` or `CLR ALL MARKS`

Related Commands: `SIGMARK`, `SIGPOS`

Example

```
OUTPUT 718; "SIGUNMARK 5;"
```

Description

The SIGUNMARK command unmarks one or more signals on the signal list. If there is no parameter selected, the signal at the cursor will be unmarked (see SIGPOS command). An integer parameter specifies a signal number to be unmarked from the signal list. An ALL parameter unmarks all signals in the signal list.

SMOOTH

Smooth Trace

Smooths the trace according to the number of points specified for the running average.

Syntax

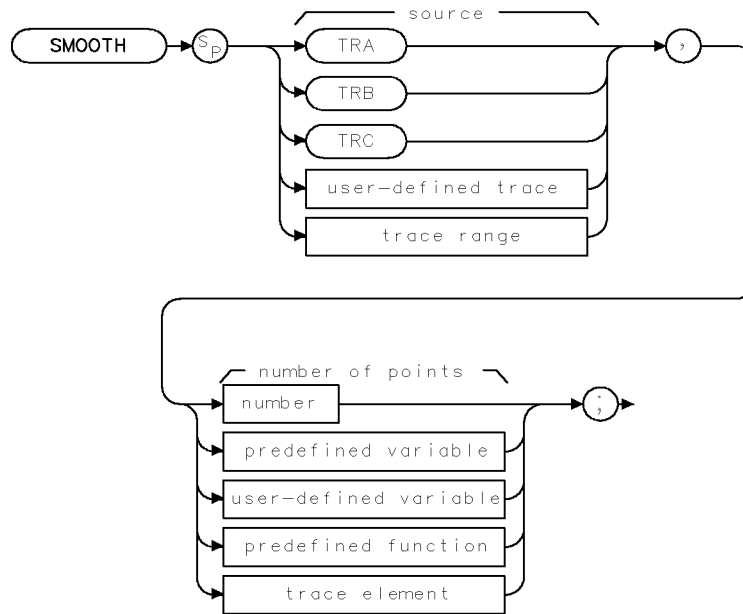

XSMOOTH .

Item	Description/Default	Range
User-defined trace	A trace defined by the TRDEF command.	Any valid trace name.
Trace range	A segment of trace A, trace B, trace C, or a user-defined trace.	
Number	Any real or integer number.	Real number range.
User-defined variable	A variable defined by VARDEF command.	Any valid variable name.
Predefined variable	A command that acts as a variable. Refer to Table 4-1.	
Predefined function	Function that returns a value. Refer to Table 4-1.	
Trace element	An element of trace A, trace B, trace C, or a user-defined trace.	

Prerequisite Commands: TRDEF when using a user-defined trace. VARDEF for a user-defined variable. TS when using trace data.

Related Commands: SNGLS, TS, VAVG

Example

```

10 OUTPUT 718;"IP;"           Initializes instrument.
20 OUTPUT 718;"SNGLS;TS;"    Activates single-sweep mode, takes a sweep.
30 OUTPUT 718;"VIEW TRA;"    Stores results of trace A.
40 OUTPUT 718;"SMOOTH TRA,10;" Smooths trace A.
50 OUTPUT 718;"VIEW TRA;"    Displays the result.
60 END

```

Description

The SMOOTH command smooths the trace according to the number of points specified for the running average.

Each point value is replaced with the average of the values (in measurement units) of the given number of points centered on it. Increasing the number of points increases smoothing at the cost of decreasing resolution. If the number of points is an even number, then the number of points is increased by one. If the number of points is larger than the size of SOURCE, then the size of SOURCE is used (unless size of SOURCE is even, in which case the size of SOURCE minus one is used). Smoothing decreases at the endpoints.

The purpose of this function is to perform a spatial video averaging as compared to the temporal version supplied by the video-average (VAVG) command. The functions of SMOOTH and VAVG are not interchangeable however. Unlike VAVG, SMOOTH averages values that occur before and after the data point in time. This can cause some display irregularities at the start and stop frequencies. Use low values for the SMOOTH parameter to avoid signal distortion.

By replacing the value of each point in a trace with the average of the values of a number of points centered about that point, any rapid variations in video noise or signals are smoothed into more gradual variations. It thereby performs a function similar to reducing the average video bandwidth without the corresponding changes in sweep time. As such, it does result in a reduction of frequency resolution. Also, signal peaks are reduced with large smoothing values, and this can cause the amplitude to appear to be low.

This command requires user memory for its execution. Memory is not permanently allocated, so the largest amount of memory is available for the functions that are used in a particular application. When the command is complete, memory is returned to the free user memory.

SNGLS

Single Sweep

Sets the instrument to single-sweep mode.

Syntax

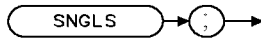

XSNGLS

Equivalent Keys: `SWEEP CONT SGL` or `(SINGLE)`

Related Commands: CLRW, CONTS, TM, TS

Example

```
OUTPUT 718;"SNGLS;"
```

Description

The SNGLS command sets the instrument to single-sweep mode. Each time TS (take sweep) is sent, one sweep is initiated, as long as the trigger and data entry conditions are met.

SP Span

Changes the total displayed frequency range symmetrically around the center frequency.

Syntax

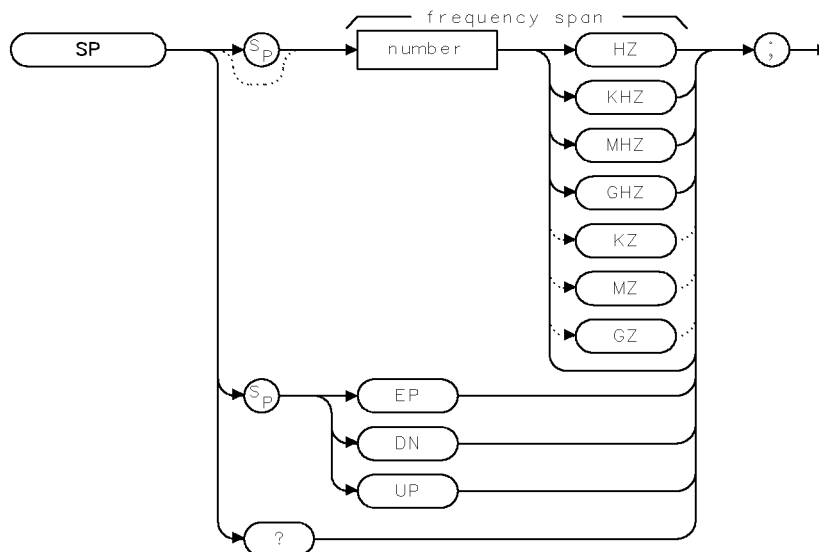

Item	Description/Default	Range
Number	Any real or integer number. Default unit is Hz.	Frequency span of the instrument.

Equivalent Keys: **SPAN** or **(SPAN)**

Step Increment: 1, 2, 5, 10 sequence (up to the stop frequency of the instrument)

Related Commands: AVBW, CF, FA, FB, FOFFSET, FS, HNLOCK, HNUNLK, IFBW, RB, ST, VB

Example

```

OUTPUT 718;"IP;SP 20MHZ;" Initializes instrument, changes frequency span.
OUTPUT 718;"SP?;" Gets the span value from the instrument.
ENTER 718;Span Puts the instrument response in the computer variable, Span.
PRINT Span Displays the span value.
    
```

SP Span

Description

The SP command changes the total displayed frequency range symmetrically around the center frequency.

The frequency span readout refers to the displayed frequency range. Dividing the readout by 10 yields the frequency span per division.

If intermediate frequency resolution and average video bandwidths are coupled to the span width, the bandwidths change with the span width to provide a predetermined level of resolution and noise averaging. Likewise, the sweep time changes to maintain a calibrated display, if coupled. All of these functions are normally coupled, unless AVBW, IFBW, RB, VB, or ST have been executed.

Because span is affected by frequency, change the frequency before changing span (see “HNLOCK”).

Specifying 0 Hz enables zero-span mode, which configures the instrument as a fixed-tuned instrument.

Query Response

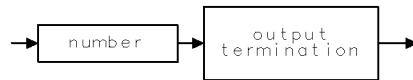

001

SPEAKER Speaker

Turns on or off the internal speaker.

Syntax

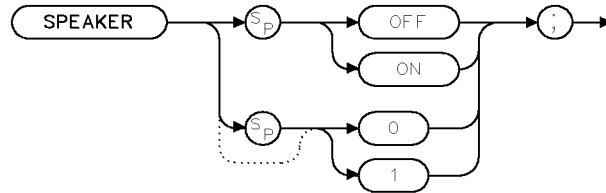

XSPEAKER .

Equivalent Softkey: `SPEAKER ON OFF`

Preset State: `SPEAKER ON`

Related Commands: `DEMOD, FMGAIN, SQLCH`

Example

```
OUTPUT 718;"SPEAKER OFF;"
```

Description

The SPEAKER command turns on or off the internal speaker.

SPZOOM

Span Zoom

Places a marker on the highest onscreen signal, turns on the signal track function, and activates the span function.

Syntax

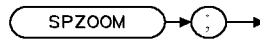

XSPZOOM

Equivalent Softkeys: **SPAN ZOOM**

Example

```
OUTPUT 718;"IP;CF 300MZ;TS;"  
OUTPUT 718;"SPZOOM;"
```

Description

The SPZOOM command places a marker on the highest onscreen signal (if a marker is not present), turns on the signal track function, and activates the span function. If a marker is present before SPZOOM is executed, SPZOOM turns on the signal track function and activates the span function.

SQLCH Squelch

Sets the squelch threshold by setting the squelch level.

Syntax

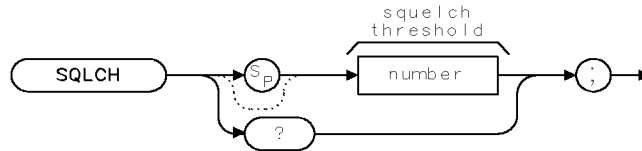

Item	Description/Default	Range
Number	Any valid integer.	0 to 100.

Equivalent Softkeys: **SQUELCH**

Preset Value: 0

Related Commands: DEMOD, FMGAIN, SPEAKER

Example

```
OUTPUT 718;"SQLCH 100;"
```

Description

The SQLCH command sets the squelch threshold by setting the squelch level. It mutes weak signals and passes strong signals.

Query Response

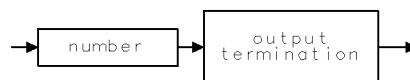

SQR

Square Root

Places the square root of the source into the destination.

Syntax

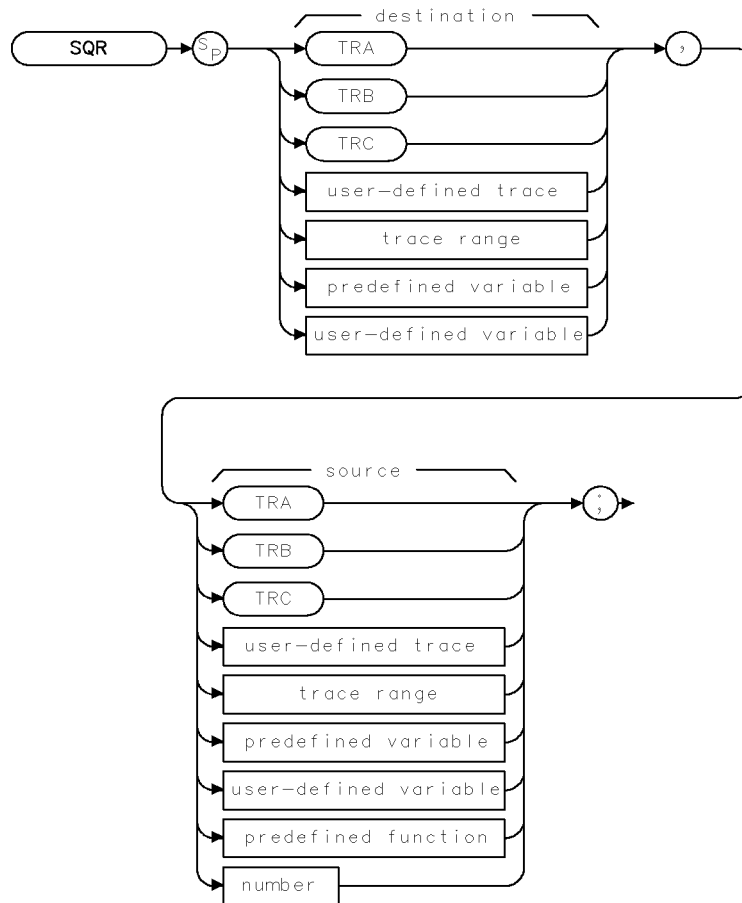

XSQR

Item	Description/Default	Range
User-defined trace	A trace defined by the TRDEF command.	Any valid trace name.
User-defined variable	A variable defined by VARDEF command.	Any valid variable name.
Predefined variable	A command that acts as a variable. Refer to Table 4-1.	
Predefined function	Function that returns a value. Refer to Table 4-1.	
Trace range	A segment of trace A, trace B, trace C, or a user-defined trace.	
Number	Any real or integer number.	Real number range.

Prerequisite Commands: TRDEF when using a user-defined trace, VARDEF for a user-defined variable, TS when using trace data.

Related Commands: PDA

Example

OUTPUT 718;"SQR SP,1E8;" *Changes the span to 10 kHz.*

Description

The SQR command places the square root of the source into the destination. If the source is negative, the square root of the absolute value will be returned.

When the source is longer than the destination, the source is truncated to fit. When the source is shorter than the destination, the last element is repeated to fill the destination.

SRCALC

Source Leveling Control

Selects internal or external leveling for use with the built-in tracking generator.

Syntax

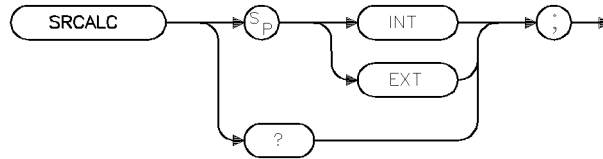

xsrcalc

Equivalent Softkey: **ALC INT EXT**
 Preset State: SRCALC INT
 Related Commands: CF, FA, FB, FS, HNLOCK, SP

Example

OUTPUT 718;"SRCALC EXT;"

Description

The SRCALC command selects internal or external leveling for use with the built-in tracking generator.

The functions of SRCALC and **ALC INT EXT** are identical.

When used as a predefined variable, SRCALC returns either 0 or 1. The value that is returned by SRCALC depends on the SRCALC parameter, as shown in the following table.

Parameter setting	Value returned
INT	0
EXT	1

Query Response

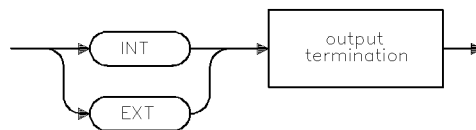

qsralc

SRCAT Source Attenuator

Attenuates the source output level.

Syntax

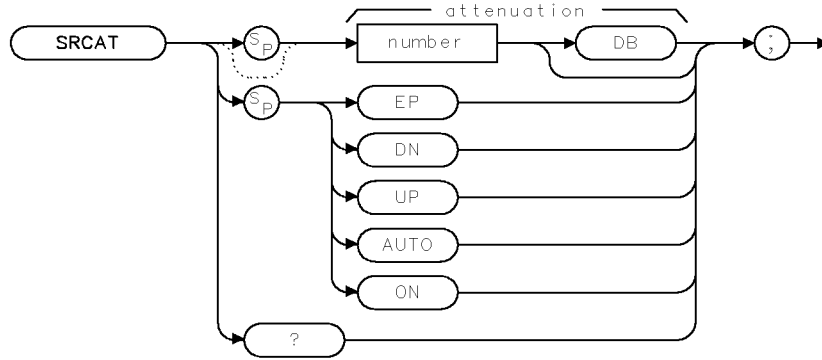

XSRCAT

Item	Description/Default	Range
Number	Any real or integer number, specified in multiples of 8 dB.	0 to 56 dB.

Equivalent Softkeys: SRC ATN MAN AUTO

Coupling: Coupled to power level of the source output (SRCPWR) when set to auto (SRCAT AUTO)

Related Commands: SRCPSTP

Preset State: SRCAT AUTO

Example

OUTPUT 718; "SRCAT 16DB;"

SRCAT Source Attenuator

Description

The SRCAT command attenuates the output level of the source. Use SRCAT to attenuate the power level of the source manually, from 0 to 56 dB in 8 dB steps.

“SRCAT AUTO;” automatically adjusts the attenuator to yield the source amplitude level specified by the SRCPWR command.

Query Response

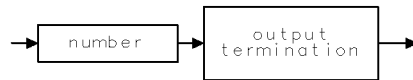

001

SRCPOFS Source Power Offset

Offsets the source power level readout.

Syntax

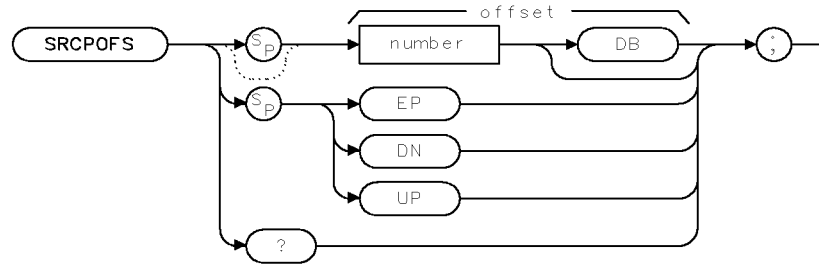

XSRCPOFS

Item	Description/Default	Range
Number	Any real or integer number.	

Equivalent Softkeys: **SRC PWR OFFSET**

Related Commands: SRCPWR, SRCPSWP

Step Increment: Determined by SRCPSTP

Preset State: 0 dB

Example

Use SRCPOFS to offset the power-level readout for the tracking-generator source.

```
OUTPUT 718;"MEASURE SR;"           Sets instrument to stimulus-response mode.
OUTPUT 718;"SUB SRCPWR,RL,20;"     Turns on source output and sets source amplitude to
                                     20 db below the reference level.
OUTPUT 718;"SRCPOFS 13DB;"        Offsets power-level readout for source by 13 dB.
```

Description

The SRCPOFS command offsets the displayed power of the built-in tracking generator. This function may be used to take into account system losses (for example, cable loss) or gains (for example, preamplifier gain) reflecting the actual power delivered to the device under test.

Query Response

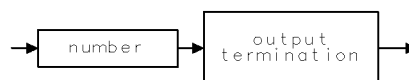

001

SRCPSTP

Source Power-Level Step Size

Selects the source-power step size.

Syntax

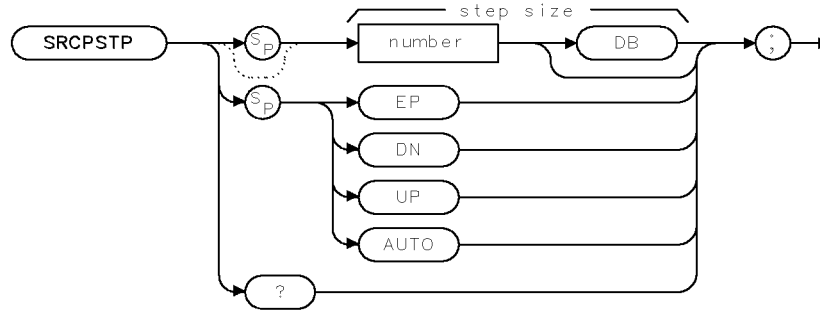

XSRCPSTP .

Item	Description/Default	Range
Number	Any real or integer number.	

Equivalent Softkeys: **SRC PWR STP SIZE**

Step Increment: 0.1 dB

Related Commands: SRCPWR, SRCPOFS, SRCPSWP

Preset State: SRCPSTP AUTO (one major vertical scale division)

Example

Select incremental changes of power effected by "SRCPWR UP;," "SRCPWR DN;," commands, or the step keys.

OUTPUT 718;"MEASURE SR;"	<i>Activates stimulus-response mode.</i>
OUTPUT 718;"SUB SRCPWR,RL,20;"	<i>Turns on the source output and sets source amplitude to 20 dB below the reference level.</i>
OUTPUT 718;"SRCPSTP .3DB;"	<i>Sets power-level step size to 0.3 dB.</i>
OUTPUT 718;"SRCPWR UP;"	<i>Increases the power level.</i>

SRCPSTP Source Power-Level Step Size

Description

The SRCPSTP command selects the step size for the following source commands:

- Power offset (SRCPOFS)
- Power sweep (SRCPSWP)
- Power (SRCPWR)

Use SRCPSTP to set the step size to a specific value.

“SRCPSTP AUTO;” sets the step size to one vertical scale division.

Query Response

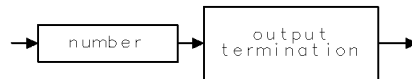

001

SRCPSWP

Source Power Sweep

Selects the sweep range of the source output.

Syntax

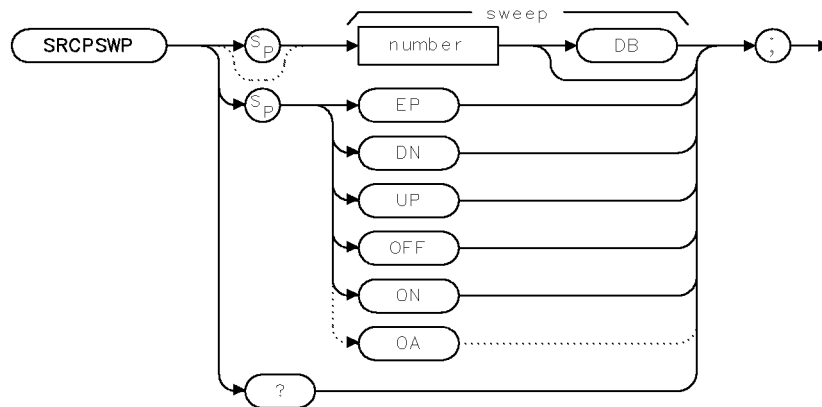

XSRCPSWP .

Item	Description/Default	Range
Number	Any real or integer number.	

- Equivalent Softkeys: **PWR SWP ON OFF**
- Step Increment: Determined by SRCPSTP
- Related Commands: SRCPSWP, SRCPOFS, SRCPSTP
- Preset State: SRCPSWP OFF

Example

Use SRCPSWP to sweep the power level of the source output.

- | | |
|--------------------------------|--|
| OUTPUT 718;"MEASURE SR;" | <i>Activates stimulus-response mode.</i> |
| OUTPUT 718;"SUB SRCPWR,RL,20;" | <i>Turns on source output and sets source amplitude to 20 dB below the reference level.</i> |
| OUTPUT 718;"SP 0;" | <i>Sets span to 0 Hz.</i> |
| OUTPUT 718;"SRCPSWP 10DB;" | <i>Sweeps source output from 20 dB below the reference level to 10 dB below the reference level.</i> |

Description

The SRCPSWP command works in conjunction with the SRCPWR (source power) command to sweep the amplitude level of the source output. The SRCPWR setting determines the amplitude level at the beginning of the sweep. The SRCPSWP command determines the change in amplitude level of the sweep.

For example, if SRCPWR and SRCPSWP are set to -15 dBm and 4 dB respectively, the source sweeps from -15 dBm to -11 dBm.

Note Power is swept from low to high.

Note An SRQ error will be returned if this command is used when the SWEEPTYPE is set to "LOG".

The minimum sweep time is limited to 20 ms when performing a source power sweep.

Query Response

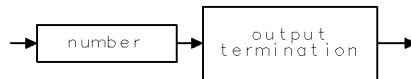

001

SRCPWR

Source Power

Selects the source power level.

Syntax

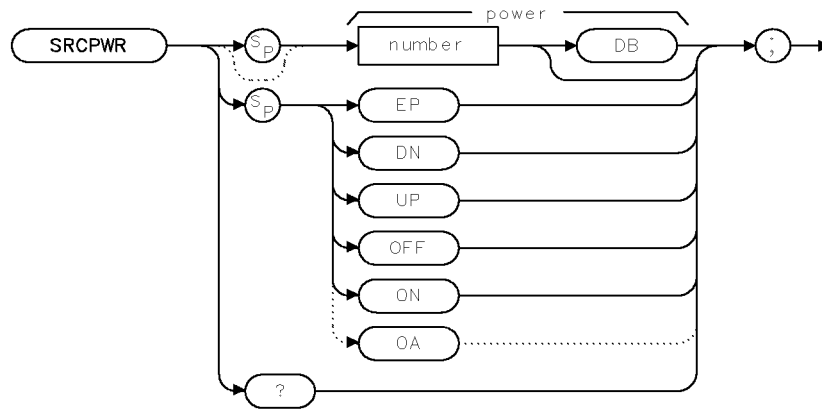

XSRCPWR

Item	Description/Default	Range
Number	Any real or integer number. Default unit is the current amplitude unit.	Actual range is hardware dependent.

Equivalent Softkeys: SRC PWR ON OFF

Step Increment: Set by SRCPSTP

Related Commands: SRCAT, SRCPSTP, SRCPSWP

Preset State: 97 dB μ V

Example

Use SRCPWR to turn on the source and adjust its power level.

OUTPUT 718;"AUNITS DBM;"	<i>Changes the current amplitude units.</i>
OUTPUT 718;"SRCPWR -20DB;"	<i>Changes power level to -20 dBm.</i>
OUTPUT 718;"AUNITS DBMV;"	<i>Changes the current amplitude unit.</i>
OUTPUT 718;"SRCPWR 37;"	<i>The source power is now 37 dBmV.</i>

Description

The SRCPWR command turns the source off or on and sets the power level of the source. The source is turned on automatically whenever its value is specified with SRCPWR. Also see “SRCPSTP.”

Query Response

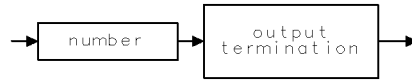

QQ1

SRCTK

Source Tracking

Adjusts the tracking of the source output with the instrument sweep.

Syntax

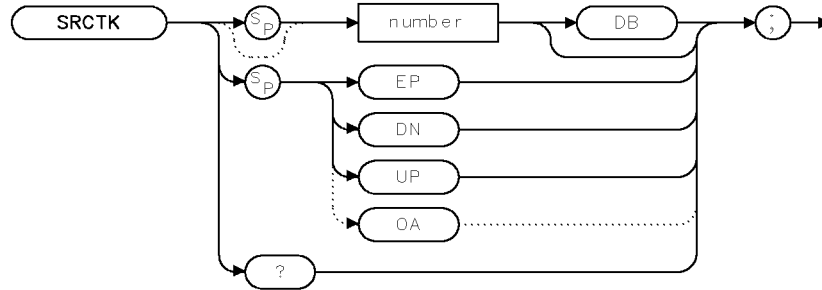

XSRCTK

Item	Description/Default	Range
Number	Any real or integer number.	0 to 16,383.

Equivalent Softkeys: **MAN TRK ADJUST**

Step Increment: 1

Related Commands: RB, VB, ST, SP, CF, FA, FB, SP, FS, SRCTKPK

Example

OUTPUT 718;"MEASURE SR;"	<i>Activates the stimulus-response mode.</i>
OUTPUT 718;"SUB SRCPWR,RL,20;"	<i>Turns on the power at the source output and sets source amplitude to 20 dB below the reference level.</i>
OUTPUT 718;"SP 1MHZ;"	<i>Sets measurement range.</i>
OUTPUT 718;"RB 1KHZ;"	
OUTPUT 718;"TS;"	<i>Takes sweep.</i>
OUTPUT 718;"SRCTK EP;"	<i>Allows entry of from front-panel keys to adjust tracking.</i>

Description

The SRCTK command adjusts the tracking of the tracking-generator output relative to the center frequency of the instrument. SRCTK is used typically for bandwidths less than 300 kHz. Bandwidths greater than 300 kHz do not require tracking adjustment. Use SRCTK to improve amplitude accuracy and maximize signal response. Use SRCTKPK to adjust tracking automatically. See “SRCTKPK.”

Query Response

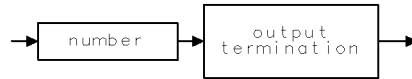

001

SRCTKPK

Source Tracking Peak

Automatically adjusts the tracking of source output with instrument sweep.

Syntax

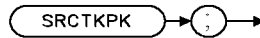

XSRCTKPK .

Equivalent Softkeys: **TRACKING PEAK**

Related Commands: RB, VB, ST, SP, CF, FA, FB, SP, FS, SRCTK

Example

OUTPUT 718;"MEASURE SR;"	<i>Activates the stimulus-response mode.</i>
OUTPUT 718;"SUB SRCPWR,RL,20;"	<i>Turns on the source output and sets source amplitude to 20 dB below the reference level.</i>
OUTPUT 718;"SP 1MHZ;"	<i>Sets measurement range.</i>
OUTPUT 718;"RB 1KHZ;"	
OUTPUT 718;"TS;"	<i>Takes sweep.</i>
OUTPUT 718;"SRCTKPK;"	<i>Automatically adjusts the tracking.</i>

Description

The SRCTKPK command adjusts the tracking of the tracking-generator source output automatically to maximize responses for measurements made with resolution bandwidths less than 300 kHz.

SRCTKPK maximizes the amplitude of the displayed active trace.

SRQ Force Service Request

Used to simulate interrupts from the instrument.

Syntax

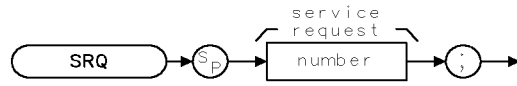

XSRQ

Item	Description/Default	Range
Number	Any valid integer.	1 to 127.

Related Commands: CLS, EE, RQS, STB

Example

OUTPUT 718;"RQS 8;SRQ 8;" *Sets bit mask for a hardware broken service request, generates a hardware broken interrupt.*

Note A program can respond to the interrupt in the same way it would under a true service request condition.

Description

The SRQ command is used by an external controller to simulate interrupts from the instrument.

The service request condition is also displayed on the screen with the annotation SRQ XXX, where XXX is a three-digit octal number.

The conditions that can generate a service request are as follows:

- 32 = Illegal command
- 16 = Command complete
- 8 = Hardware broken
- 4 = End of sweep
- 2 = Units key pressed
- 1 = Overload detected

A service request is generated only if the proper request mask bit has been set (see "RQS"), and either the condition itself or the Force Service Request is sent. To set the request mask, choose the desired interrupt conditions and sum their assigned values. Executing the RQS command with this value sets the bit mask. After setting the bit mask, only the chosen conditions can produce an interrupt.

Each bit in the status byte is defined as shown in the following table.

SRQ Force Service Request

Table 4-7. Instrument Status Byte

Bit Number	Decimal Equivalent	Instrument State	Description
5	32	Set when an illegal command is present.	SRQ 140 appears on the screen.
4	16	Set when any command is completed.	It is triggered by EOI at the end of a command string or the completion of a print or plot.
3	8	Indicates hardware broken condition.	SRQ 110 appears on the screen.
2	4	Indicates end of sweep.	SRQ 104 appears on the screen. If you send any RQS value that contains mask value 4, another sweep will be taken.
1	2	Indicates a units key was pressed.	SRQ 102 appears on the screen. If you activate the units key bit, it will remain active until you activate "EE" and press a units key. (See "EE.")
0	1	Indicates an overload was detected.	SRQ 101 appears on the screen.

Bit numbers **6** and **7** are not used.

The screen numbers 101, 102, 104, and 110 are the octal values corresponding to the status register values; that is, SRQ 102 = bit 6 = octal 100 and bit 2 = octal 2 are both true.

Generally, you must set the bit mask using the RQS command. However, the "hardware broken", "illegal remote command", and overload detected conditions are automatically enabled after presetting or sending the IP command. Pressing **PRESET** or sending the IP command, then, produces the same interrupt bit mask as sending "RQS 41;" (decimal 41 is the sum of the assigned values of the three interrupt bits, 32 = bit 5, 8 = bit 3 and 1 = bit 0).

For most conditions, the RQS mask bit stays set until the next instrument preset (IP), or RQS command is executed.

When a units key is pressed, the interrupt occurs and the Units Key Pressed bit in the RQS mask is reset. To reenable the Units Key Pressed interrupt, you must send a new RQS mask. See "RQS" for detailed information.

As mentioned, you can simulate a service request condition. Choose the desired interrupt conditions from the RQS command table (see "RQS"), and sum their assigned values. Use the RQS command with this value to set the bit mask. By setting the corresponding bits in the SRQ command and sending the SRQ command to the instrument, the desired interrupt occurs. This allows the user to verify proper operation of software routines designed to handle infrequent or unlikely interrupts.

Interface Differences

As implemented on the HP-IB interface, an instrument service request asserts the SRQ control line on the HP-IB.

On the RS-232 interface, the instrument does not have a way of signaling the interrupt condition to a controller. In this case, the controller must operate in a polled mode if it requires interrupt information (see "Polled Mode of Operation" below for a discussion of the polled mode).

Interrupt-Related Commands Common to All Interfaces:

- CLS Clear status byte, without read
- RQS Request mask
- SRQ Force service request
- STB Read then clear status byte

The HP-IB interface supports interface commands to read the status byte.

On HP-IB in HP 9000 Series 200 or 300 BASIC, the statement SPOLL (Device_address) can be used to read the status byte.

Polled Mode of Operation

The polled mode of operation is probably most applicable to an RS-232 interface user. Because there is no interrupt signal to the RS-232 controller, the user must periodically ask the instrument, via the "STB?" command, for the contents of its status register. For example, the RS-232 controller could periodically check for the hardware-broken condition by executing the "STB?" command and reading the results.

SS

Center Frequency Step Size

Specifies center frequency step size.

Syntax

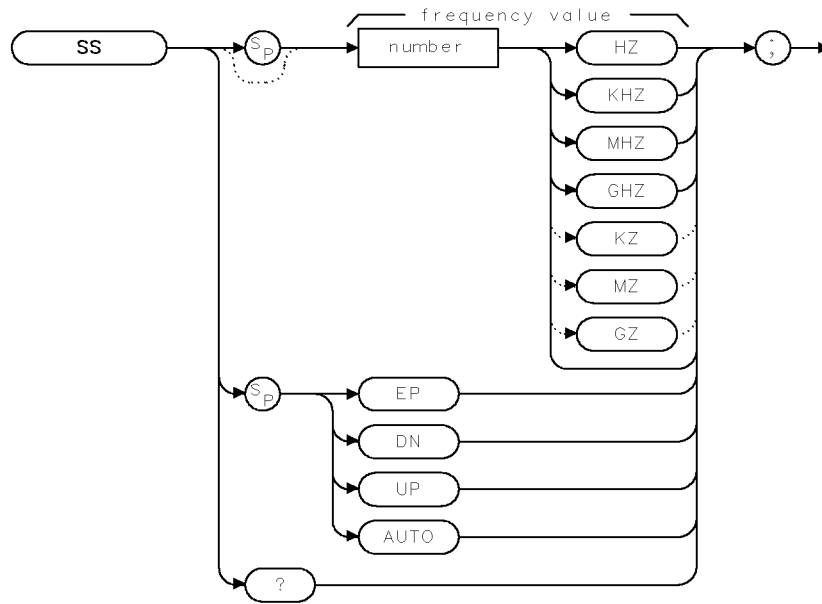

XSS

Item	Description/Default	Range
Number	Any real or integer number. Default unit is Hz.	Frequency range of the instrument.

Equivalent Softkeys: **CF STEP AUTO MAN**

Preset State: 100 MHz

Step Increment: 1, 2, 5, 10 sequence

Prerequisite Commands: VARDEF when using a user-defined variable

Related Commands: AUTO, CF, FOFFSET, SP

SS Center Frequency Step Size

Example

10 CLEAR 718	<i>Clears the HP-IB.</i>
20 OUTPUT 718;"IP;SNGLS;CF 300MHZ;SP 20MHZ;TS;"	<i>Initializes the instrument, activates single-sweep mode, changes the center frequency, span, takes sweep.</i>
30 OUTPUT 718;"MKPK HI;MKRL;TS;MKF?;"	<i>Finds the highest peak, changes the reference level to the marker, takes sweep, returns the frequency of the marker.</i>
40 ENTER 718 USING "K";Mk_freq	<i>Puts the instrument response in the computer variable, Mk_freq.</i>
50 OUTPUT 718;"MKA?;"	<i>Returns the amplitude of the marker.</i>
60 ENTER 718 USING "K";Mk_amp	<i>Puts the instrument response in the computer variable, Mk_amp.</i>
70 OUTPUT 718;"SS ";Mk_freq;"HZ"	<i>Changes the step size to the marker frequency.</i>
80 OUTPUT 718;"CF UP;TS;MKPK HI;MKA?;"	<i>Increases the center frequency, takes sweep, puts the marker on the highest peak and returns the amplitude of the marker.</i>
90 ENTER 718;Mk_ampl	<i>Puts the instrument response in the computer variable, Mk_ampl.</i>
100 PRINT "THE FUNDAMENTAL IS ";Mk_amp-Mk_ampl	<i>Outputs the result.</i>
110 PRINT "dB ABOVE THE SECOND HARMONIC"	
120 END	

Description

The SS command specifies center frequency step size.

The AUTO parameter removes SS as an active function but does not have an effect on its value.

Query Response

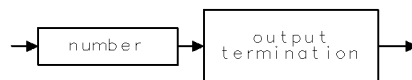

QQ1

ST

Sweep Time

Specifies the time in which the instrument sweeps the displayed frequency range.

Syntax

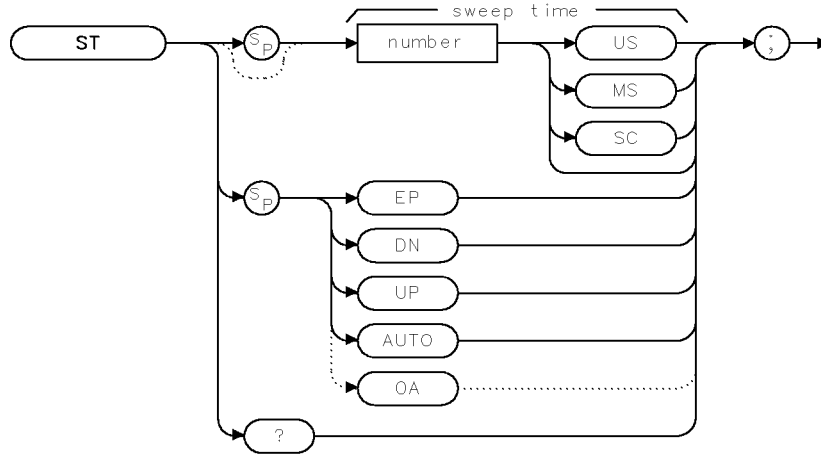

XST

Item	Description/Default	Range
Number	Any real or integer number. Default unit is seconds.	Within the sweep time range of the instrument.

Equivalent Softkeys: **SWP TIME AUTO MAN**

Sweep Time Range in Zero Span: 15 ms to 100 s

Sweep Time Range in Non-zero Span: 20 ms to 100 s

Step Increment: 2, 3, 5, 7.5, 10, 15 sequence

Prerequisite Commands: VARDEF when using a user-defined variable

Related Commands: AUTO, AVBW, CONTS, HNLOCK, HNUNLK, IFBW, RB, SNGLS, SP, SRCPSWP, TS

Example

OUTPUT 718; "ST 100MS;" *Sets the sweep time to 100 milliseconds.*

Description

The ST command specifies the time in which the instrument sweeps the displayed frequency range. When used as a predefined variable, ST returns the sweep time as a real number in seconds.

Query Response

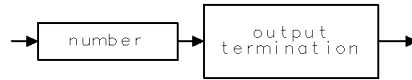

QQ1

STB Status Byte Query

Returns to the controller the decimal equivalent of the status byte.

Syntax

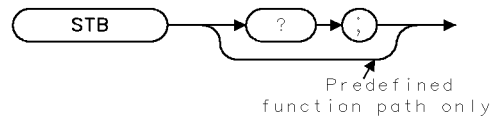

XSTB

Related Commands: RQS, SRQ

Example

```
10 OUTPUT 718;"IP;"      Initializes instrument.
20 OUTPUT 718;"SNGLS;"   Activates single-sweep mode.
30 OUTPUT 718;"CLS;"     Clears the status bits.
40 OUTPUT 718;"TS;"      Takes sweep.
50 OUTPUT 718;"STB?;"    Returns the status bits.
60 ENTER 718;Status_Byte Puts the instrument response in the computer variable, Sta-
                        tus_Byte.
70 PRINT Status_byte     Displays the result.
80 END
```

Description

The STB command returns to the controller the decimal equivalent of the status byte. The STB command is equivalent to a serial poll command. The RQS and associated bits are cleared in the same way that a serial poll command would clear them. The bits in the status byte are explained under the RQS command.

Query Response

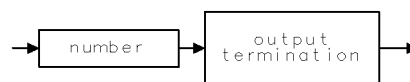

QQ1

STOR Store

Stores data to a disk file.

Syntax

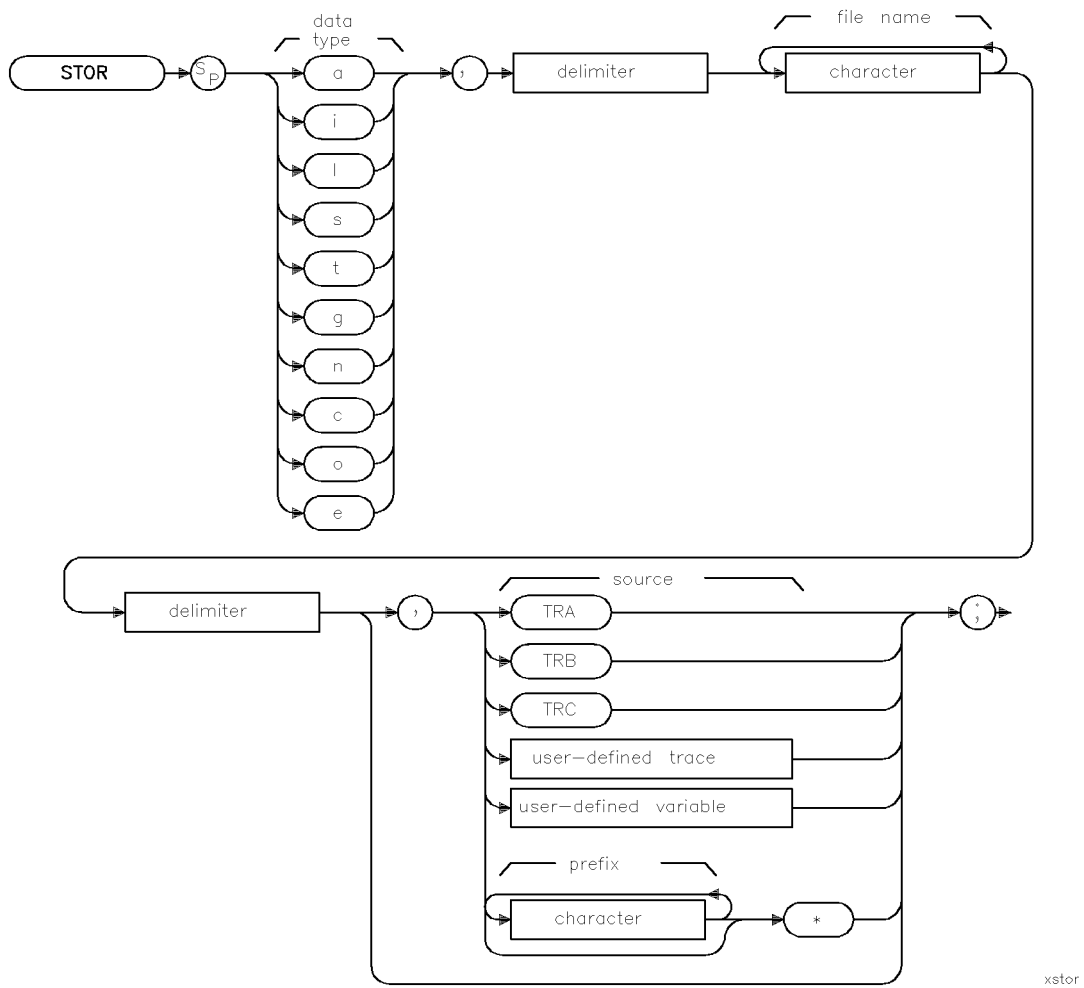

STOR Store

Item	Description/Default	Range
User-defined trace	A trace defined by the TRDEF command.	Any valid trace name.
User-defined variable	A variable defined by VARDEF command.	Any valid variable name.
Character (file name)	Any valid character. Characters form the file type and file name.	Data type (lowercase a, c, e, g, i, l, n, o, s, or t) should precede the file name in LIF format. In DOS format, the suffix should follow the file name. Refer to Table 4-8.
Character (prefix)	Any valid character.	
Delimiter	Matching characters marking the beginning and end of the list of instrument commands.	~ \ @ = / ^ \$ % ; ! ' : " &

Related Commands: CAT, LOAD, PREFIX, PROTECT

Example

LIF Format

OUTPUT 718;"TRDEF N_EW,400;"	<i>Defines a trace.</i>
OUTPUT 718;"MOV N_EW,TRA;"	<i>Moves the contents of trace A into N_EW.</i>
OUTPUT 718;"STOR t,%F_UNCX%,N_EW;"	<i>Stores N_EW under the file name of tFUNCX as trace data.</i>
OUTPUT 718;"STOR n,%nA_MPDATA_7%;"	<i>Stores the current antenna correction factors.</i>
OUTPUT 718;"STOR l,%lL_LIMITS_1%;"	<i>Stores the current limit-line tables.</i>
OUTPUT 718;"STOR s,%sS_TATE_1%;"	<i>Stores the instrument state.</i>

DOS Format

OUTPUT 718;"TRDEF N_EW,400;"	<i>Defines a trace.</i>
OUTPUT 718;"MOV N_EW,TRA;"	<i>Moves the contents of trace A into N_EW.</i>
OUTPUT 718;"STOR ,%F_UNCX.TRC%,N_EW;"	<i>Stores N_EW under the file name of tFUNCX as trace data.</i>
OUTPUT 718;"STOR n,%A_MPDATA_7.ANT%;"	<i>Stores the current antenna correction factors.</i>
OUTPUT 718;"STOR l,%L_LIMITS_1.LIM%;"	<i>Stores the current limit-line tables.</i>
OUTPUT 718;"STOR s,%S_TATE_1.STA%;"	<i>Stores the instrument state.</i>

Description

The STOR command stores the source data to a disk file under the specified file name and data type.

Data type: The data type is either s, t, l, i, g, n, c, o, or e, refer to Table 4-8 for a complete description. The selected data type will require the file name to include the matching prefix in LIF format or suffix in DOS format. A trace file has a data type of "t", therefore, in LIF format the file name must be preceded by "t". For example, "t ATRACE". In DOS format the suffix must be ".TRC". For example, "ATRACE.TRC".

Table 4-8. LIF or DOS Data Types

LIF Prefix	DOS Suffix	File Description	Result
s	.STA	Instrument state	Stores the instrument state.
t	.TRC	Trace	Stores the trace and state.
l	.LIM	Limit lines	Stores the limit-line values from the current limit-line table.
i	.BMP	Display image file	Stores displays image as a 16-color bit map.
g	.SIG	Signal list	Stores the signal list and its associated annotation.
n	.ANT	Antenna correction factors	Stores the antenna correction factors.
c	.CBL	Cable correction factors	Stores the cable correction factors.
o	.OTH	Other correction factors	Stores other correction factors.
e	.ALL	All information	Stores all information, including traces, states, windows, correction factors, and limit lines.

Note The STOR command saves data to a floppy disk. See “SAVET” or “SAVES” to save data in internal memory.

Specifying the source

When storing trace data, enter the location of the trace data (trace A, trace B, trace C, user-defined trace, user-defined variable or multiple variables (prefix*)) as the source.

Disk requirements: To store a file to a floppy disk, there must be enough space on the floppy disk for the file. If the file name is already on the disk, PROTECT must be off for the file to be stored.

SUB

Subtract

Subtracts source 2 from source 1.

Syntax

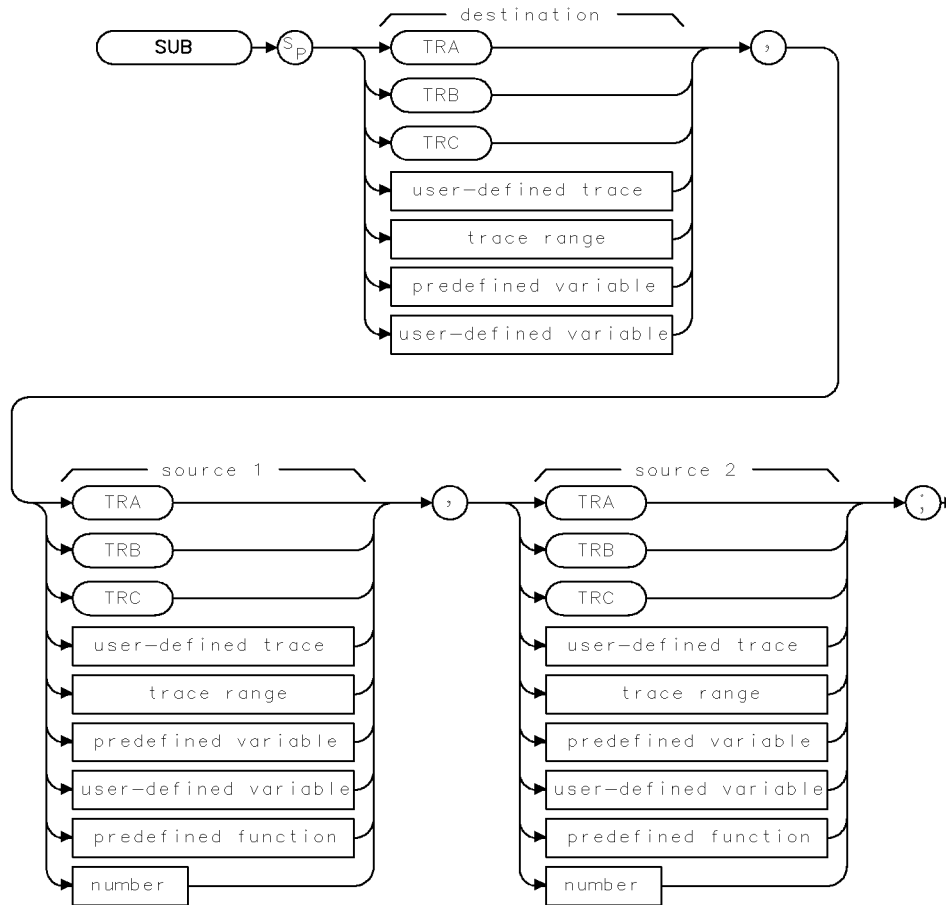

XSUB

Item	Description/Default	Range
User-defined trace	A trace defined by the TRDEF command.	Any valid trace name.
User-defined variable	A variable defined by VARDEF command.	Any valid variable name.
Predefined variable	A command that acts as a variable. Refer to Table 4-1.	
Predefined function	Function that returns a value. Refer to Table 4-1.	
Trace range	A segment of trace A, trace B, trace C, or a user-defined trace.	
Number	Any real or integer number.	Real number range.

Prerequisite Commands: TRDEF when using a user-defined trace. VARDEF for a user-defined variable. TS when using trace data.

Related Commands: AMB, AMBPL, BML, LIMITEST, SUM

Example

OUTPUT 718;"SUB TRA,TRB,TRC;" *Subtracts trace C from trace B and places the result in trace A.*

Description

The SUB command subtracts source 2 from source 1, point by point, and sends the difference to the destination.

When the source is longer than the destination, the source is truncated to fit. When the source is shorter than the destination, the last element is repeated to fill the destination.

SUM

Sum of Trace Amplitudes

Returns the sum of the amplitudes of the trace elements in measurement units.

Syntax

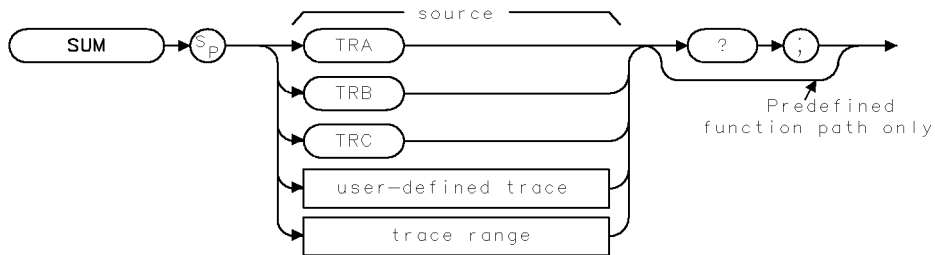

XSUM

Item	Description/Default	Range
User-defined trace	A trace defined by the TRDEF command.	Any valid trace name.
Trace range	A segment of trace A, trace B, trace C, or a user-defined trace.	

Prerequisite Commands: TRDEF when using a user-defined trace. TS when using trace data.

Related Commands: ADD, DIV, MEAN, MPY, SUB, TS, VARIANCE

Example

```

10 OUTPUT 718;"IP;"           Initializes instrument.
20 OUTPUT 718;"SNGLS;TS;"     Activates single-sweep mode, takes sweep.
30 OUTPUT 718;"SUM TRA?;"    Gets the result.
40 ENTER 718;Trace_sum       Puts the instrument response in the computer
                               variable, Trace_sum.
50 DISP Trace_sum;"MEASUREMENT UNITS" Displays the result.
60 END

```

SUM Sum of Trace Amplitudes

Description

The SUM command returns the sum of the amplitudes of the trace elements.

Query Response

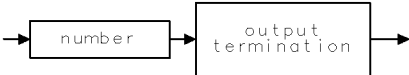

001

SUMSQR

Sum of Squared Trace Amplitudes

Returns the sum of the squares of the amplitude of each trace element in measurement units.

Syntax

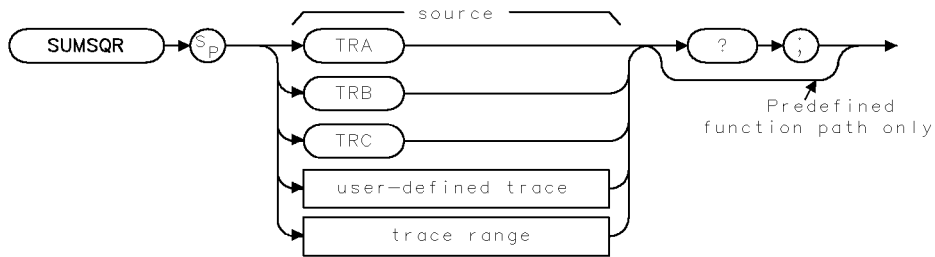

XSUMSQR .

Item	Description/Default	Range
User-defined trace	A trace defined by the TRDEF command.	Any valid trace name.
Trace range	A segment of trace A, trace B, trace C, or a user-defined trace.	

Prerequisite Commands: TRDEF when using a user-defined trace. TS when using trace data.

Example

```

OUTPUT 718;"IP;"           Initializes instrument.
OUTPUT 718;"SNGLS;TS;"    Activates single-sweep mode, takes sweep.
OUTPUT 718;"SUMSQR TRA?;" Gets the result.
ENTER 718;Trace_sqrsum    Puts the instrument response in the computer variable, Trace_sqrsum.

DISP Trace_sqrsum;"MEASUREMENT UNITS" Displays the result.

```

Description

The SUMSQR command returns the sum of the squares of the amplitude of each trace element in measurement units.

Query Response

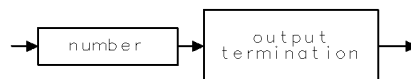

001

SWEEPTYPE Sweep Type

Selects a linear or logarithmic frequency axis.

Syntax

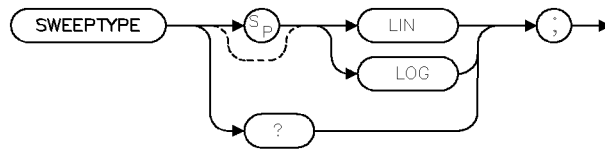

xswptyp

Equivalent Softkeys: **SWEEP LOG LIN**
 Preset State: SWEEPTYPE LIN
 Related Commands LOGSWEEPSPD

Example

OUTPUT 718;"SWEEPTYPE LIN;"

Description

The SWEEPTYPE command selects the frequency axis stimulus and graticule display. When “LIN” is selected the frequency axis is linear. When “LOG” is selected the frequency axis is logarithmic.

Query Response

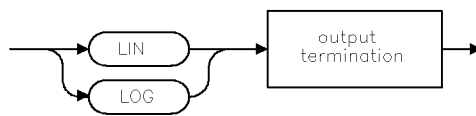

qswptyp

SWPCPL

Sweep Couple

Selects either a stimulus-response or receiver auto-coupled sweep time.

Syntax

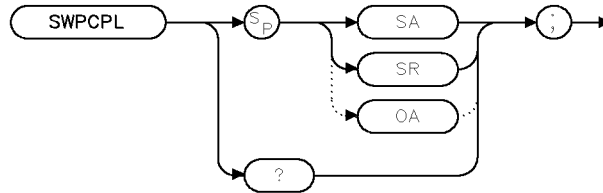

XSWPCPL

Equivalent Softkeys: SWP CPLG SR RECV

Preset State: SWPCPL RECV

Related Commands: SRCPWR

Example

```

10 OUTPUT 718;"IP;SNGLS;"
20 OUTPUT 718;"FA 300KHZ;FB 1GHZ;"
30 OUTPUT 718;"SUB SRCPWR,RL,10;"
40 OUTPUT 718;"SWPCPL SR;"
50 OUTPUT 718;"SRCTKPK;DONE?;"
60 ENTER 718;Done
70 LOCAL 718
80 END
  
```

Description

The SWPCPL command selects either a stimulus-response (SR) or receiver (SA) auto-coupled sweep time.

In stimulus-response mode, auto-coupled sweep times are usually much faster for swept-response measurements. Stimulus-response auto-coupled sweep times are typically valid in stimulus-response measurements when the frequency span is less than 20 times the bandwidth of the device under test.

When used as a predefined variable, SWPCPL returns either a "0" or a "1," depending on the setting of the SWPCPL parameters. Refer to the following table.

Parameter setting	Value returned
SA	0
SR	1

Query Response

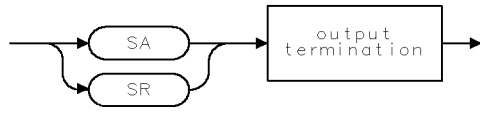

QSWPCPL .

TA Transfer A

Returns trace A amplitude values from the instrument to the controller.

Syntax

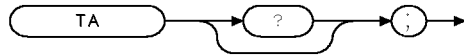

XTA

Related Commands: MDS, TB, TDF

Example

This example stores the TA results in array A.

<code>DIM A(401)</code>	<i>Reserves memory area for array.</i>
<code>OUTPUT 718;"IP;"</code>	<i>Initializes instrument.</i>
<code>OUTPUT 718;"SNGLS;CF 300MHZ;SP 2MHZ;TS;"</code>	<i>Activates single-sweep mode, changes center frequency and span, takes sweep.</i>
<code>OUTPUT 718;"TDF P;TA;"</code>	<i>Changes trace data format, outputs trace A.</i>
<code>FOR N = 1 TO 401</code>	<i>FOR NEXT loop moves each element of trace A to the computer.</i>
<code>ENTER 718;A(N)</code>	
<code>NEXT N</code>	
<code>FOR N = 1 TO 401</code>	<i>FOR NEXT loop moves the trace values from the computer to the printer.</i>
<code>PRINT A(N)</code>	<i>Prints out the results.</i>
<code>NEXT N</code>	

Description

The TA command returns trace A amplitude values from the instrument to the controller. The display unit values are transferred in sequential order (from left to right) as seen on the screen.

Transfer of trace amplitude data should be done only as follows:

1. Select single sweep mode (SNGLS).
2. Select desired instrument settings.
3. Take one complete sweep (TS).
4. Transfer data (TA).

This procedure ensures that the current settings of the instrument are reflected in the transferred data.

See the section, “Different Formats for Trace Data Transfers,” in Chapter 3 for more information about transferring trace data. Items are separated by a comma when in TDF P format.

Query Response

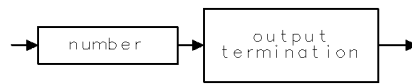

QQ1

TB Transfer B

Transfers trace B amplitude values from the instrument to the controller.

Syntax

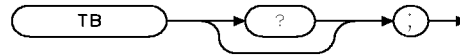

XTB

Related Commands: MDS, TA, TDF

Example

```
DIM A(401)
OUTPUT 718;"IP;"
OUTPUT 718;"SNGLS;CF 300MHZ;SP 2MHZ;TS;"

OUTPUT 718;"TDF P;TB;"

FOR N = 1 TO 401

    ENTER 718;A(N)
NEXT N
FOR N = 1 TO 401

    PRINT A(N)
NEXT N
```

Reserves memory area for array.

Initializes instrument.

Activates single-sweep mode, changes center frequency and span, takes sweep.

Changes trace data format, outputs trace B.

FOR NEXT loop moves each element of trace A to the computer.

FOR NEXT loop moves the trace values from the computer to the printer.

Prints out the results.

Description

The operation of TB is similar to the operation of TA.

See the section, "Different Formats for Trace Data Transfers," in Chapter 3 for more information about transferring trace data.

Query Response

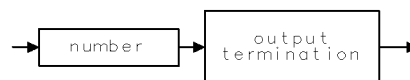

QQ1

TBLDEF Table Definition

Specifies which elements of a table are output to the printer.

Syntax

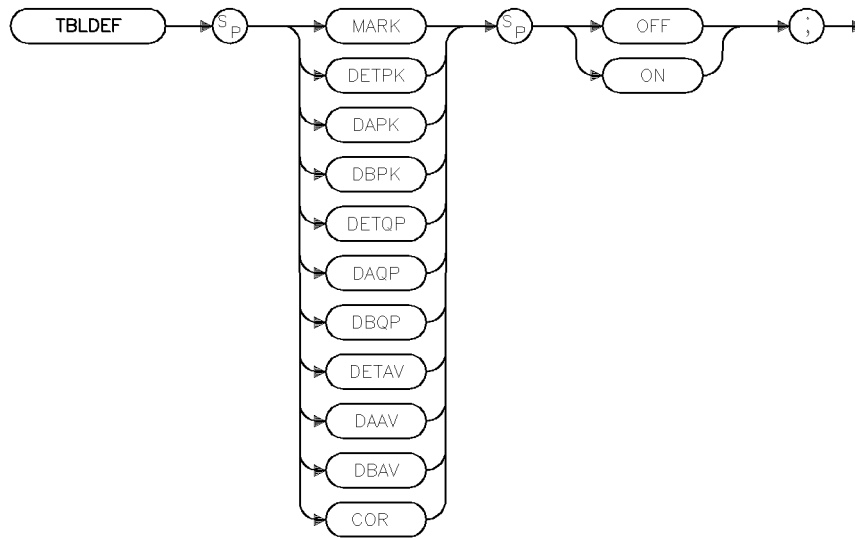

xtbldef

Equivalent Softkey: the softkeys accessed by **Define List**

Related Commands: RPTDEF

Example

```
OUTPUT 718; "TBLDEF MARK ON;"
```

Description

The TBLDEF command specifies which elements of a table are output to the printer upon receipt of **OUTPUT REPORT**. If any of the elements are set to on, they will be included as part of the list portion of the report. Each element will be its own labeled column. The sequence of columns is: signal marked (MARK), peak detector (DETPK), peak delta from limit 1 (DAPK), peak delta from limit 2 (DBPK), quasi-peak detector (DBQP), average detector (DETA), average delta from limit 1 (DAAV), average delta from limit 2 (DBAV), and total correction factors (COR).

TDF

Trace Data Format

Formats trace information for return to the controller.

Syntax

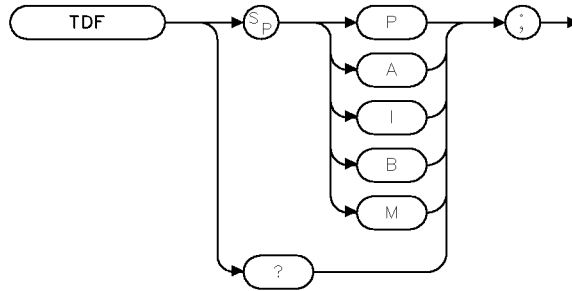

X TDF

Related Commands: MDS, MKA, TA, TB, TRA

Example

```
DIM A(401)
OUTPUT 718;"IP;"
OUTPUT 718;"BLANK TRA;CLRWB TRB;"
OUTPUT 718;"SNGLS;CF 300MHZ;SP 2MHZ;TS;"
```

Holds trace data.
Initializes instrument.
Views trace B
Activates single-sweep mode, changes center frequency and span.
Formats trace data.
Transfers trace data to array A, one element at a time.

```
OUTPUT 718;"TDF P;TB;"
FOR N = 1 TO 401

    ENTER 718;A(N)
    NEXT N
FOR N = 1 TO 401
    PRINT A(N)
NEXT N
```

Loop prints out trace B data.
Prints out the results.

Description

The TDF command formats trace information for return to the controller. The different trace data formats are as follows:

TDF P

Description: TDF P is the real number format. An example of a trace element returned with the real number format is 10.00 dB. When querying the trace or marker value, the value is returned using the amplitude unit set by AUNITS (for example, watts or dBm).

Restrictions: The instrument must be in log scale to use TDF P. To send the trace data back to the instrument, the data must be converted to measurement units.

How data is returned: The following table describes what is transferred when the trace data format is set to P, but the AUNITS are changed. In every case, the trace data transfer is ended by a carriage return, and a line feed with an EOI.

Trace Data Transfers with TDF P

AUNITS Setting	Example	Description
Watts	TDF P;AUNITS W;TA;	Transfers 401 real values, in watts, with each value separated by a carriage return and a line feed.
dBm	TDF P;AUNITS DBM;TA;	Transfers 401 real values, in dBm, with each value separated by a carriage return and a line feed.
dBmV	TDF P;AUNITS DBMV;TA;	Transfers 401 real values, in dBmV, with each value separated by a carriage return and a line feed.
dB μ V	TDF P;AUNITS DBUV;TA;	Transfers 401 real values, in dB μ V, with each value separated by a carriage return and a line feed.
Volts	TDF P;AUNITS V;TA;	Transfers 401 real values, in volts, with each value separated by a carriage return and a line feed.

Example of how data is returned: For example, if the reference level of the instrument is set to -10 dBm, the amplitude scale is set to 10 dB per division, and trace A contains the following data:

TRA[1] contains 8000 (in measurement units). The value 8000 indicates trace element 1 is at the reference level.

TRA[2] = 7000 measurement units (trace element 2 is -10 dB below the reference level).

TRA[3] through TRA[401] each contain 6000 (in measurement units). The value 6000 indicates that the trace elements 3 through 401 are all at -20 dB below the reference level.

Querying trace A with the TDF P format and AUNITS set to DBM returns ASCII character codes for the following:

-10.00,-20.00,-30.00,(-30.00 is repeated 398 times),<CR><LF><EOI>

TDF A

Description: TDF A is the A-block data format. With the A-block data format, trace data is preceded by “#,” “A,” and a two-byte number (the two byte number indicates the number of trace data bytes). The setting of the MDS command determines whether the trace data is transferred as one or two 8-bit bytes.

Restrictions: To use the A-block format for sending data, you must provide the number of data bytes.

How data is returned: The following table describes what is transferred when the trace data format is set to A, but the MDS setting is changed.

TDF Trace Data Format

Trace Data Transfers with TDF A

MDS Setting	Example	Description
Binary	TDF A;MDS B;TA;	Transfers "#A," the number of bytes of trace data, then the 401 bytes of trace data. Using MDS B "reduces" each trace value into one byte by dividing (DIV) the trace value by 32. The trace data transfer is ended with an EOI.
Word	TDF A;MDS W;TA;	Transfers "#A," the number of bytes of trace data, then 802 bytes of trace data. MDS W uses two bytes per trace element to transfer trace data. The first byte contains the trace value divided by (DIV) 256, the second byte contains the remainder (MOD) of that division. The trace data transfer is ended with an EOI.

Example of how data is returned: For the same trace A data that is used in the TDF P description, querying trace A with the TDF A format and MDS set to binary (MDS B) would return the ASCII character codes for the following:

```
#A(401 div 256)(401 mod 256)(8000 div 32)(7000 div 32)(6000 div 32)(the number for 6000 div 32 is repeated 398 times)<EOI>
```

Notice that #A is followed by the two bytes that contain the number of trace elements. Because MDS is set to binary, the number of trace elements is 401.

If MDS is set to W, querying trace A with the TDF A format would return the ASCII character codes for the following:

```
#A(802 div 256)(802 mod 256)(8000 div 256)(8000 mod 256)(7000 div 32)(7000 mod 256)(6000 div 256)(6000 mod 256)(the number for 6000 div 256, then the number for 6000 mod 256 is repeated 398 times)
```

Notice that #A is followed by the two bytes that contain the number of trace elements. Because MDS is set to W (word), the number of trace elements is 802.

TDF I

Description: TDF I is the I-block data format. With the I-block data format, trace data must be preceded by "#," and "I." The setting of the MDS command determines whether the trace data is transferred as one or two 8-bit bytes. Unlike using the A-block format, you do not provide the number of data bytes when sending trace data back to the instrument.

Restrictions: This format is not recommended for use with an RS-232 interface.

How data is returned: The following table describes what is transferred when the trace data format is set to I, but the MDS setting is changed.

Trace Data Transfers with TDF I

MDS Setting	Example	Description
Binary	TDF I;MDS B;TA;	Transfers "#I," then the 401 bytes of trace data. Using MDS B "reduces" the trace value into 1 byte by dividing (DIV) the trace value by 32. The trace data transfer is ended with an EOI.
Word	TDF I;MDS W;TA;	Transfers "#A," then 802 bytes of trace data. MDS W uses two bytes per trace element to transfer trace data. The first byte contains the trace value divided by (DIV) 256, the second byte contains the remainder (MOD) of that division. The trace data transfer is ended with an EOI.

TDF Trace Data Format

Example of how data is returned: For the same trace A data that is used in the TDF P description, querying trace A with the TDF I format and MDS set to binary (MDS B) would return the ASCII character codes for the following:

```
#I(8000 div 32)(7000 div 32)(6000 div 32)(the number for 6000 div 32 is repeated 398 times)
```

If MDS is set to W, querying trace A with the TDF I format would return the ASCII character codes for the following:

```
#I(8000 div 256)(8000 mod 256)(7000 div 32)(7000 mod 256)(6000 div 256)(6000 mod 256)(the number for 6000 div 256, then the number for 6000 mod 256 is repeated 398 times)
```

TDF B

Description: TDF B enables the binary format. With the binary format, the marker or trace data is transferred as bytes. Of all the trace data formats, TDF B transfers trace data the fastest. The setting of the MDS command determines whether the trace data is transferred as one or two 8-bit bytes.

Restrictions: The TDF B format cannot be used to send data back to the instrument (you must use the A-block format to send data back to the instrument).

How data is returned: The following table describes what is transferred when the trace data format is set to B, but the MDS setting is changed.

Trace Data Transfers with TDF B

MDS Setting	Example	Description
Binary	TDF B;MDS B;TA;	Transfers the 401 bytes of trace data. Using MDS B “reduces” the trace value into 1 byte by dividing (DIV) the trace value by 32. The trace data transfer is ended with an EOI.
Word	TDF B;MDS W;TA;	Transfers the 802 bytes of trace data. MDS W uses two bytes per trace element to transfer trace data. The first byte contains the trace value divided by (DIV) 256, the second byte contains the remainder (MOD) of that division. The trace data transfer is ended with an EOI.

Example of how data is returned: For the same trace A data that is used in the TDF P description, querying trace A with the TDF B format and MDS set to binary (MDS B) would return the ASCII character codes for the following:

```
(8000 div 32)(7000 div 32)(6000 div 32)(the number for 6000 div 32 is repeated 398 times)
```

If MDS is set to W, querying trace A with the TDF B format would return the ASCII character codes for following:

```
(8000 div 256)(8000 mod 256)(7000 div 32)(7000 mod 256)(6000 div 256)(6000 mod 256)(the number for 6000 div 256, then the number for 6000 mod 256 is repeated 398 times)
```

TDF M

Description: TDF M is the measurement data format. The measurement data format transfers trace data in measurement units, and the measurement data can range from -32768 to $+32767$.

Restrictions: TDF M cannot be used to send trace data back to the instrument.

How trace data is returned: The following table describes what is transferred when the trace data format is set to M.

TDF Trace Data Format

Trace Data Transfers with TDF M

Example	Description
TDF M;TA;	Transfers 401 bytes, with each trace value in measurement units. The trace data transfer is ended with a carriage return, a line feed with an EOL.

Example of how data is returned: For the same trace A data that is used in the TDF P description, querying trace A with the TDF M would return the ASCII character codes for the following:

8000,7000,6000,(6000 repeated 398 times),<CR><LF>

Refer to the section, “Different Formats for Trace Data Transfers,” in Chapter 3 for more information about transferring trace data.

Query Response

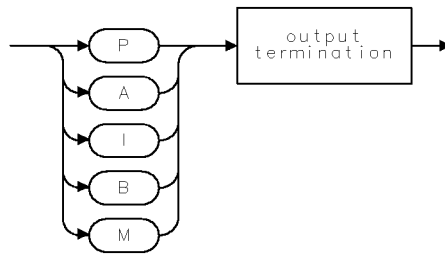

QTDF

TH Threshold

Clips signal responses below the threshold level.

Syntax

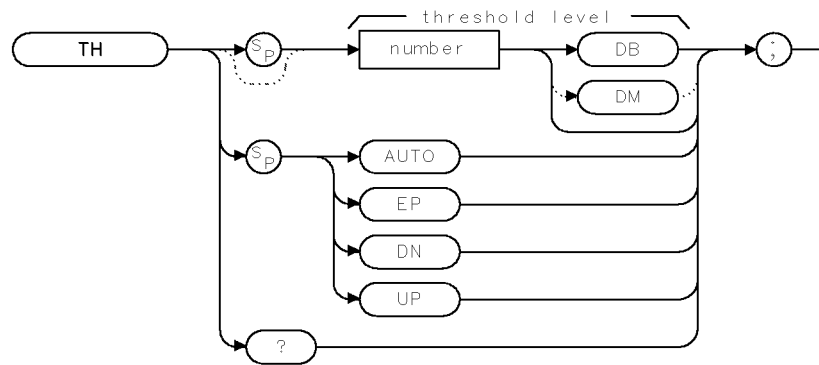

XTH

Item	Description/Default	Range
Number	Any real or integer number.	Range dependent on RL setting.

Equivalent Softkeys:

THRESHLD ON OFF

Preset State:

Clip off, positioned at the bottom graticule line.

Step Increment:

One division

Related Commands:

AUTO, DL, MEANTH, MKPK, PEAKS, RL

Example

OUTPUT 718;"TH UP;" *Increases the threshold level.*

TH Threshold

Description

The TH command clips signal responses below the threshold level. The threshold level is eight graticule divisions below the top of the screen unless otherwise specified. The threshold level is annotated in reference level units at the lower-left corner of the screen. AUTO deactivates clipping. The TH level is used for next peak marker movements (see “MKPK”) and the PEAKS command even if the display clipping is off.

Query Response

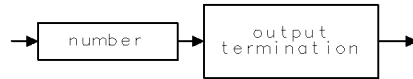

001

TIMEDATE Time Date

Sets the time and date for the instrument's real-time clock.

Syntax

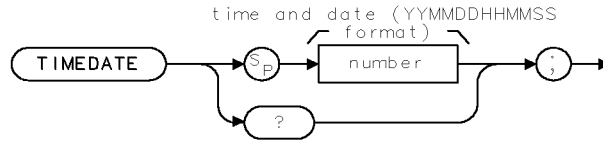

XTIMEDATE

Item	Description/Default	Range
Number	A number representing the date and time in the YYMMDDHHMMSS (24 hour) format.	A valid date and time.

Equivalent Softkeys: **Time Date**

Related Commands: SETDATE, SETTIME, TIMEDSP

Example

OUTPUT 718;"TIMEDATE 881231135501;" *Sets the instrument time and date to 1:55:01 PM on 31 December 1988.*

Description

The TIMEDATE command sets the time and date for the instrument's real-time clock in the YYMMDDHHMMSS format.

Query Response

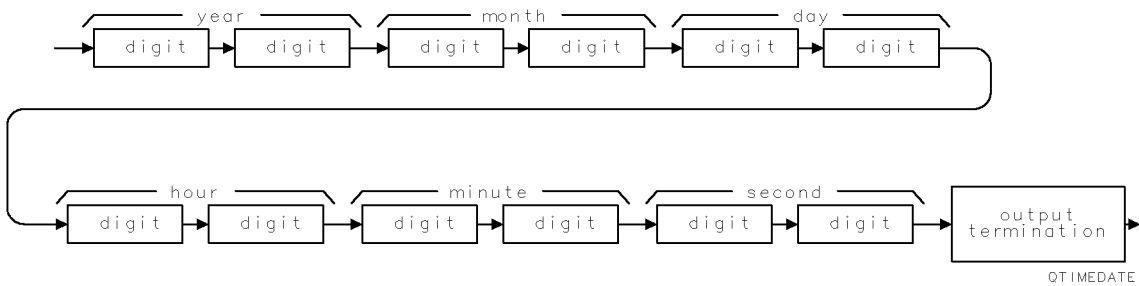

QTIMEDATE

TIMEDSP

Time Display

Enables the display of the time and date.

Syntax

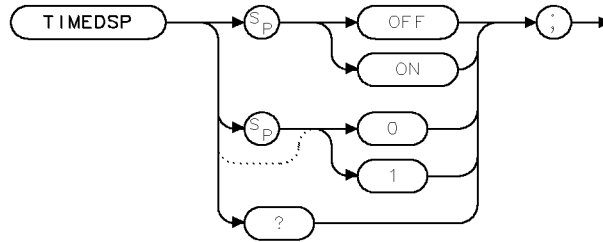

XTIMEDSP

Equivalent Softkeys: **TIMEDATE ON OFF**

Related Commands: ANNOT, SETDATE, SETTIME, TIMEDATE

Example

```
OUTPUT 718;"TIMEDSP OFF;"
```

Description

The TIMEDSP command enables the display of the time and date on the instrument screen.

Query Response

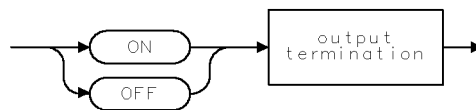

QQ2

TITLE Title

Activates the screen title mode.

Syntax

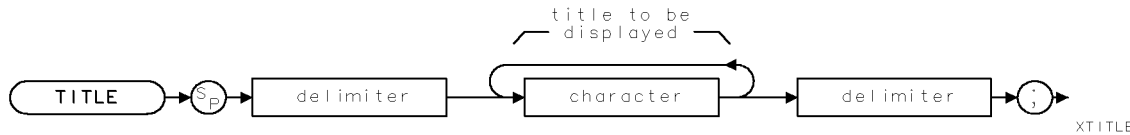

Item	Description/Default	Range
Delimiter	Matching characters marking the beginning and end of the list of instrument commands.	~ \ @ = / ^ \$ % ; ! ' : " &

Equivalent Softkeys: the softkeys accessed by **Change Title**

Related Commands: IP, SAVES

Example

OUTPUT 718;"TITLE %ADJUST ANTENNA%;" *Displays "ADJUST ANTENNA" on the screen.*

Description

The TITLE command activates the screen title mode. The title is displayed above the top graticule and is left justified. The full width of the display is available for writing a maximum of 40 characters. However, the marker readout may interfere with the last 26 characters. IP clears the title.

The SAVET command saves the screen title along with the trace in the trace register.

TM Trigger Mode

Selects a trigger mode.

Syntax

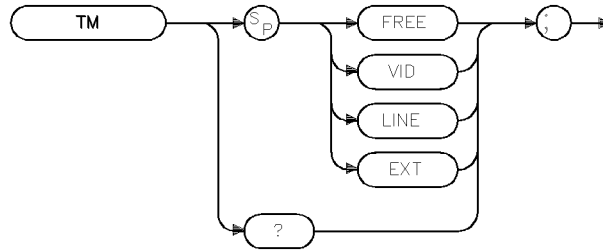

XTM

Equivalent Softkeys: the softkeys accessed by **TRIG**

Related Commands: DL

Example

OUTPUT 718;"TM EXT;" *Activates the external trigger mode.*

Description

The TM command selects a trigger mode: free, line, video, or external. The conditions of the four trigger modes are as follows:

- FREE** allows the next sweep to start as soon as possible after the last sweep. The functions of TM FREE and **FREE RUN** are identical.
- VID** allows the next sweep to start if the trace data rises across a level set by the display line. The functions of TM VID and **VIDEO** are identical.
- LINE** allows the next sweep to start when the line voltage passes through zero, going positive. The functions of TM LINE and **LINE** are identical.
- EXT** allows the next sweep to start when an external voltage level passes through approximately 1.5 V, going positive. The external trigger signal level must be between 0 V and +5 V. Connect the external trigger to the EXT TRIG INPUT. The functions of TM EXT and **EXTERNAL** are identical.

Note Some instrument functions are not performed until the instrument is triggered.

Query Response

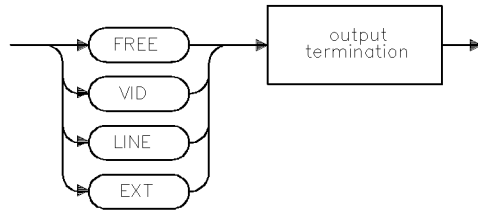

QTM

TRA/TRB/TRC

Trace Data Input and Output

The TRA/TRB/TRC commands provide a method for returning or storing 16-bit trace values.

Syntax

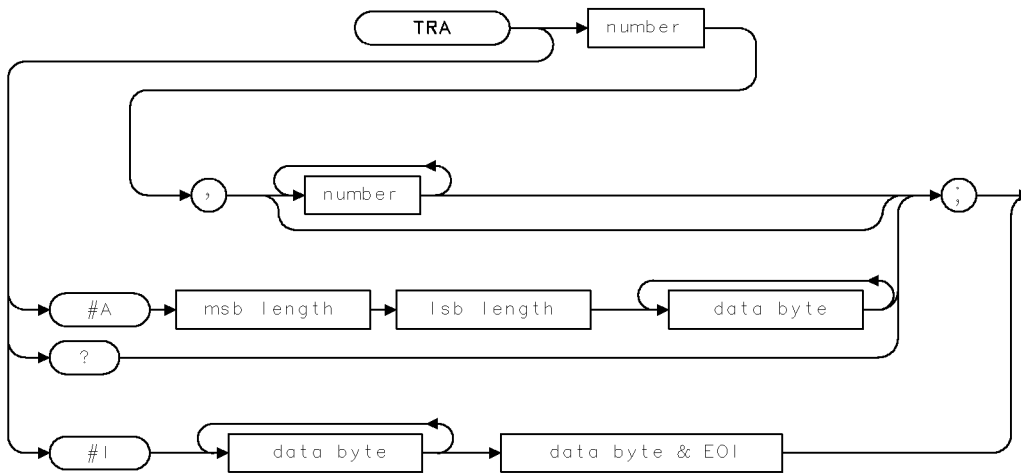

XTRA

Use the same syntax for TRB and TRC as shown for TRA, just substitute TRB or TRC for TRA.

Item	Description/Default	Range
Number	Any real or integer number.	Integer number range
Msb length	Most significant byte of a two-byte word that describes the number of bytes transmitted.	
Lsb length	Least significant byte of a two-byte word that describes the number of bytes transmitted.	
Data byte	8-bit byte containing numeric or character data.	
Data byte & EOI	8-bit byte containing numeric or character data followed by END.	

Related Commands: LOAD, RCLT, SAVET, STOR, TDF

Example

```

10 REAL Trace_a(1:401)           Creates a 401-point trace array.
20 OUTPUT 718;"IP;"             Initializes instrument.
30 OUTPUT 718;"TDF P;"         Changes the format for real numbers.
40 OUTPUT 718;"SNGLS;"
50 OUTPUT 718;"CF 300MHZ;"     Changes the center frequency.
60 OUTPUT 718;"SP 200MHZ;"    Changes the span.
70 OUTPUT 718;"TS;"
80 OUTPUT 718;"MKPK HI;"
90 OUTPUT 718;"MKCF;"         Moves peak to center of screen.
100 OUTPUT 718;"TS;"          Updates measurement trace.
110 OUTPUT 718;"TRA?;"        Gets the trace data.

```

TRA/TRB/TRC Trace Data Input and Output

```
120 ENTER 718;Trace_a(*)      Sends the trace data to the computer.
130 OUTPUT 718;"CONTS;"      Activates continuous sweep mode.
140 END
```

Description

The TRA/TRB/TRC commands provide a method for returning or storing 16-bit trace values.

Trace data that is input in the A-block or the I-block format is treated as measurement units independent of trace data format (TDF). Enter words in measurement units only. The output format is specified according to TDF and MDS.

The command may be used to input integer data to traces. See "Saving Trace Data" in Chapter 3. Because the lengths of trace A, trace B, and trace C are fixed, there are always 401 or 802 bytes transferred during binary input or binary output mode, respectively.

Query Response

The form of the query response is dependent upon the previously used TDF and MDS commands as follows:

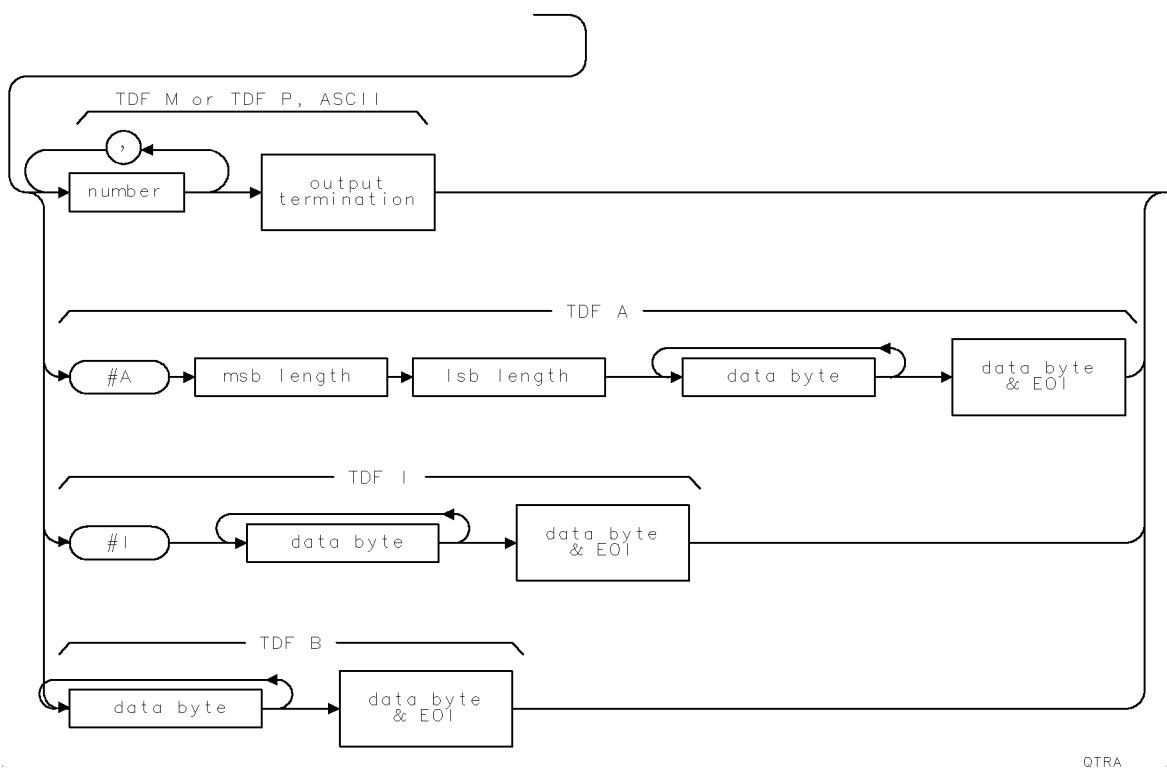

TRCMEM

Trace Memory

Indicates the number of trace registers available for SAVET and RCLT.

Syntax

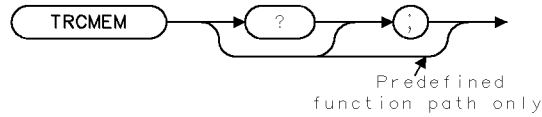

XTRCMEM .

Related Commands: DISPOSE, RCLT, SAVET, TRDEF

Example

```
OUTPUT 718;"TRCMEM?;" Gets the total number of trace registers.
ENTER 718;Number
DISP Number
```

Description

The TRCMEM command returns a positive integer that indicates the total number of trace registers available for SAVET and RCLT. The value of TRCMEM is displayed on the instrument display when you save a trace, limit-line table, or table of amplitude correction factors in instrument memory with `Trace -> Internl`.

Query Response

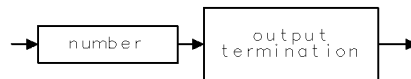

001

TRDEF Trace Define

Creates a user-defined trace.

Syntax

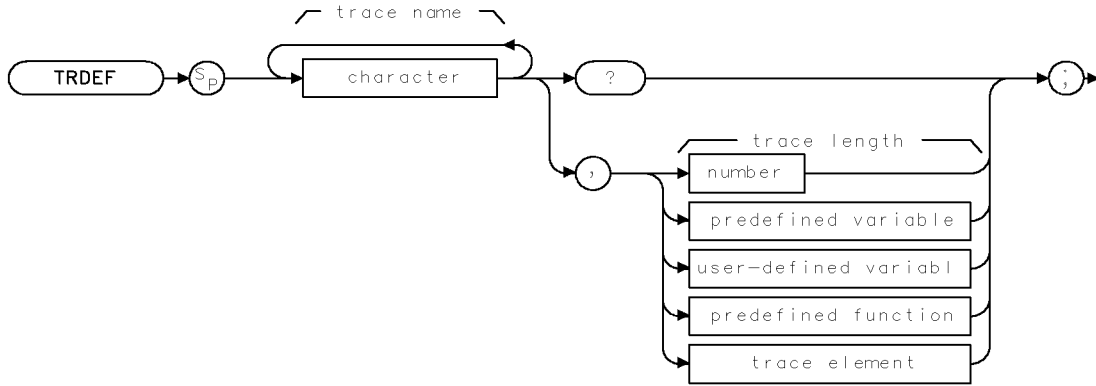

XTRDEF

Item	Description/Default	Range
Character	Any valid character.	2 to 11 characters long, A through Z and the underscore (the underscore should be used as the second character of the label).
User-defined variable	A variable defined by VARDEF	Any valid variable name.
Predefined variable	A command that acts as a variable. Refer to Table 4-1.	
Predefined function	Function that returns a value. Refer to Table 4-1.	
Trace element	An element of trace A, trace B, trace C, or a user-defined trace.	
Number	Any real or integer number.	2 to 2047.

Parameter Value: 2 to 2047

Prerequisite Commands: VARDEF when using a user-defined variable

Related Commands: DISPOSE

Example

OUTPUT 718; "TRDEF NEW,100;" *Defines a trace called NEW.*

TRDEF Trace Define

Description

The TRDEF command defines a trace and the number of points the trace will contain. Each trace element consists of 16 bits and stores the trace amplitude in measurement units. See the description for the TDFM format that is described in “Different Formats for Trace Data Transfers” in Chapter 3 for more information about measurement units.

Query Response

The query response returns the number of trace elements in the trace.

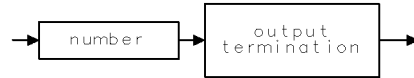

Q01

TRDSP Trace Display

Turns on or off the display of trace A, B, or C.

Syntax

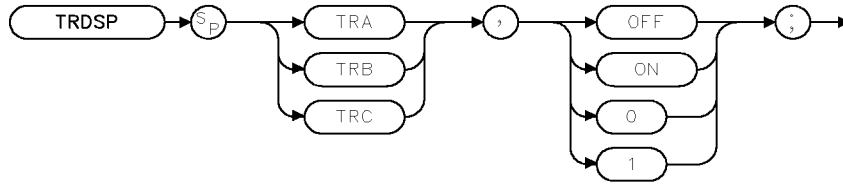

XTRDSP

Related Commands: TRPRST, TRSTAT

Example

```
OUTPUT 718;"TRDSP TRA,OFF;"
```

Description

The TRDSP command turns on or off the display of trace A, B, or C without clearing the trace (measurements can still be taken). TRDSP OFF reduces the time duration between sweeps.

TRPRST

Trace Preset

Sets the trace operations to their preset values.

Syntax

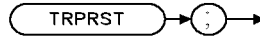

XTRPRST .

Related Commands: AMB, BLANK, CLRW, DISPOSE, DL, IP, TH

Example

```
OUTPUT 718;"TRPRST;"
```

Description

The TRPRST command sets the trace operations to their preset values. TRPRST executes these commands:

```
AMB OFF
AMBPL OFF
BLANK TRB
BLANK TRC
CLRW TRA
DL OFF
EM
TH OFF
```

TRSTAT Trace Status

Returns the status of traces A, B, and C.

Syntax

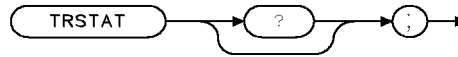

XTRSTAT .

Related Commands: BLANK, CLRW, DET, MINH, TRDSP, VIEW

Example

This example returns the measurement state of traces A, B, and C.

```
DIM States$[40]           Declares array for results.
OUTPUT 718;"TRSTAT?;"    Returns the status results to the computer.
ENTER 718 USING "-K";States$
PRINT States$            Prints out status of traces.
```

Description

The TRSTAT command returns the status of traces A, B, or C: clear write, blank, view, minimum hold, or maximum hold.

Query Response

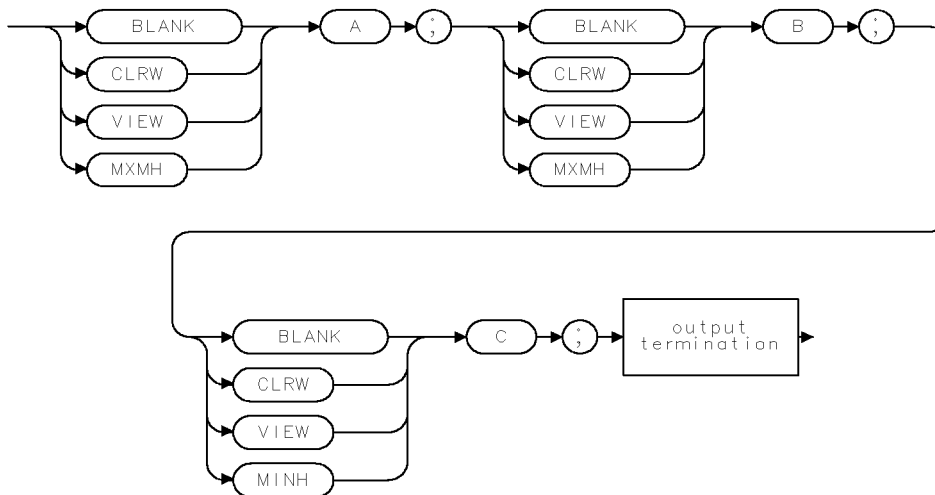

QTRSTAT .

TS Take Sweep

Starts and completes one full sweep before the next command is executed.

Syntax

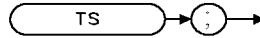

XTS

Related Commands: SNGLS, TM

Example

OUTPUT 718;"SNGLS;TS;" *Activates the single-sweep mode, and performs a take sweep.*

Description

The TS command starts and completes one full sweep before the next command is executed. A take sweep is required for each sweep in the single-sweep mode. TS prevents further input from the interface bus until the sweep is completed to allow synchronization with other instruments.

In the example below, the command sequence does not allow sufficient time for a full sweep of the specified span before VIEW is executed. Therefore, only the span set by the instrument is displayed in trace A.

```
OUTPUT 718;"IP;SNGLS;CF 400MHZ;SP 20KHZ;VIEW TRA;"
```

A TS command inserted before VIEW makes the instrument take one complete sweep before displaying trace A. This allows the instrument sufficient time to respond to each command in the

sequence.

```
OUTPUT 718;"IP;CF 400MHZ;SP 20MHZ;TS;VIEW TRA;"
```

TS is recommended before transmission of marker data and before executing marker operations such as peak search. This is because the active marker is repositioned at the end of each sweep. When the instrument receives a TS command, it is not ready to receive any more data until one full sweep has been completed. However, when slow sweep speeds are being used, the controller can be programmed to perform computations or address other instruments while the instrument completes its sweep.

Note When MKPAUSE or MKSTOP are activated, TS considers the sweep complete when it reaches the active marker.

TWINDOW Trace Window

Creates a window trace array for the fast Fourier transform (FFT) function.

Syntax

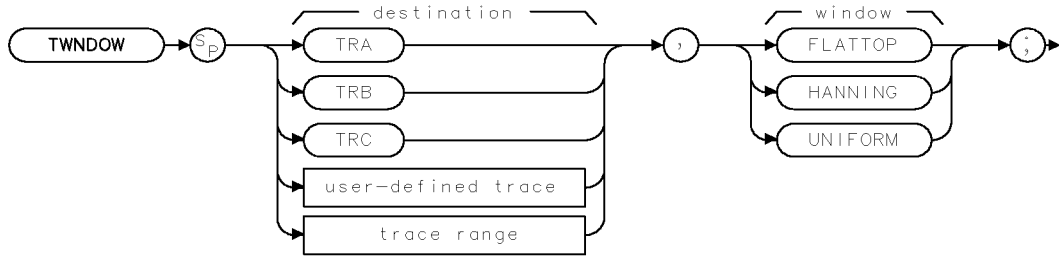

XTWINDOW .

Item	Description/Default	Range
User-defined trace	A trace defined by the TRDEF command.	Any valid trace name.
Trace Range	A segment of trace A, trace B, trace C, or a user-defined trace	

Prerequisite Commands: TRDEF when using a user-defined trace. TS when using trace data.

Related Commands: FFT

Example

Connect calibrator signal to the instrument input.

```

OUTPUT 718;"IP; CALSW INT;"           Initializes instrument.
OUTPUT 718;"CF 300MHZ;"               Changes the center frequency.
OUTPUT 718;"SP OHZ;ST 800MS;"         Changes span, sweep time.
OUTPUT 718;"TRDEF NEW,401;"           Defines a trace called NEW.
OUTPUT 718;"TWINDOW NEW,UNIFORM;"     Trace NEW stores the window algorithm, UNIFORM.
OUTPUT 718;"CLRWB TRB;"
OUTPUT 718;"SNGLS;TS;TS;"             Activates single-sweep mode and updates trace.
OUTPUT 718;"FFT TRA,TRB,NEW;"         Performs fast Fourier transform on trace B and stores the results in trace A.

OUTPUT 718;"BLANK TRB;"
OUTPUT 718;"VIEW TRA;"                Displays the result.

```

Description

The TWINDOW command creates a window trace array for the fast Fourier transform (FFT) function. The trace window function creates a trace array according to three built-in algorithms: UNIFORM, HANNING, or FLATTOP. When used with the FFT command, the three algorithms give resultant passband shapes that represent a give-and-take between amplitude uncertainty, sensitivity, and frequency resolution. See "FFT" for more information about these algorithms and the FFT function.

UDKDEFINE

User-Defined Key

Redefines a user-defined key.

Syntax

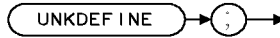

xudkdef .

Equivalent Softkey: `DEFINE USER KEY`

Related Commands: `UDKSET`

Example

```
10 PRINTER IS 1
20 OUTPUT 718; "UDKDEFINE;"
30 LOCAL 718
40 PRINT "Press a softkey on the instrument for a new USER-DEFINED KEY."
50 PRINT "Press 'Continue' on computer when finished."
60 PAUSE
70 OUTPUT 718; "UDKSET 2;"
80 END
```

Description

The UDKDEFINE command sets the instrument in a mode for redefining a user-defined key. It freezes the display and presents instructions in the active function area. The mode is exited upon a UDKSET command which is issued remotely or by pressing one of two user-defined keys. IP and POWERON will also exit this mode.

UDKSET User-Defined Key Set

Changes the definition of a user-defined key.

Syntax

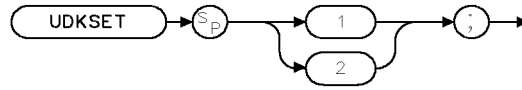

xudkset .

Equivalent Softkey: `DEFINE USER KEY`

Related Commands: `UDKDEFINE`

Example

```

10 PRINTER IS 1
20 OUTPUT 718; "UDKDEFINE;"
30 LOCAL 718
40 PRINT "Press a softkey on the instrument for a new USER-DEFINED KEY."
50 PRINT "Press 'Continue' on computer when finished."
60 PAUSE
70 OUTPUT 718; "UDKSET 2;"
80 END

```

Description

The UDKSET command changes the definition of one of the two user-defined keys. It replaces the key label and function of the user-defined key with the last softkey pressed prior to the executing the UDKSET command.

UDKSET 1 replaces the top user-defined softkey.

UDKSET 2 replaces the bottom user-defined softkey.

UNRANGE

UnRange

Restores the reference level to the value that was set prior to the last matching RANGE command.

Syntax

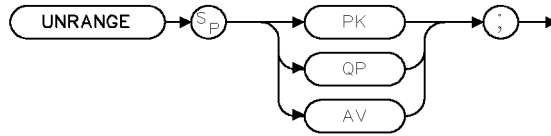

xunrange .

Related Commands: RANGE

Example

```
OUTPUT 718; "UNRANGE PK;"
```

Description

The UNRANGE command restores the reference level, to the value that was set, prior to the last matching RANGE command.

UP

Up

Increases the value of the active function.

Syntax

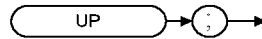

XUP

Related Commands: See the list of active functions listed in the description for UP.

Example

```
OUTPUT 718;"IP;MKN;IFBW 10KHZ;MKPK NH;UP;"
```

Increases the intermediate frequency bandwidth to 30 kHz because MKPK NH does not change the active function.

Description

The UP command increases the value of the active function by the applicable step size. Before executing UP, be sure that the function to be increased is the active function. For example, the programming example increases the resolution bandwidth, because marker peak (MKPK) is not an active function.

The active functions are: AVBW, AT, CF, DL, FA, FB, FMGAIN, IFBW, LG, MKA, MKD, MKFCR, MKN, MKPAUSE, MKPX, ML, NRL, RB, RCLS, ROFFSET, RL, RLPOS, SAVES, SETDATE, SETTIME, SP, SQLCH, SRCALC, SRCAT, SRCPOFS, SRCPSWP, SRCPWR, SRCTK, SS, ST, TH, VB, and VBR.

VARDEF

Variable Definition

Creates a user-defined variable and assigns it a value.

Syntax

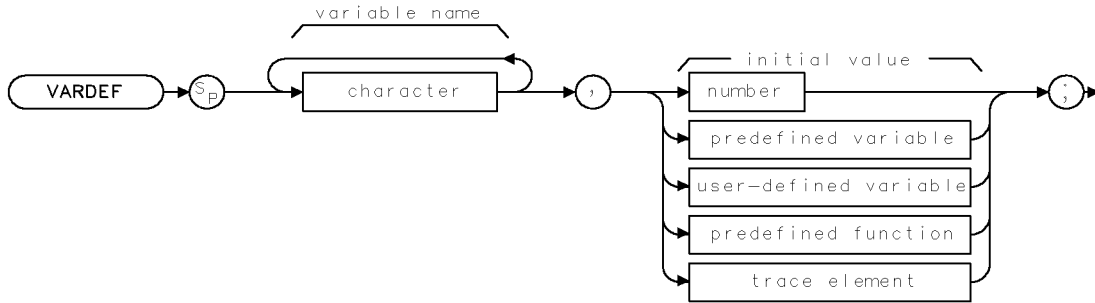

XVARDEF

Item	Description/Default	Range
Character	Any valid character.	2 to 11 characters long, A through Z and the underscore (the underscore should be used as the second character of the label).
Number	Any real or integer number.	Real number range.
User-defined variable	A variable defined by VARDEF.	Any valid variable name.
Predefined variable	A command that acts as a variable. Refer to Table 4-1.	
Predefined function	Function that returns a value. Refer to Table 4-1.	
Trace element	An element of trace A, trace B, trace C, or a user-defined trace.	

Related Commands: DISPOSE, TRDEF

Example

```
OUTPUT 718;"VARDEF V_AR,0;"
```

Defines variable called V_AR and assigns it a value of 0.

```
DISP "ENTER THE VALUE OF THE VARIABLE USING THE INSTRUMENT KEYS"
```

```
OUTPUT 718;"V_AR EP;"
```

The value of V_AR is changed by using the front-panel controls.

```
OUTPUT 718;"V_AR?;"
```

```
ENTER 718;N
```

Returns entered value of V_AR to the computer.

```
PRINT N
```

Displays value on the computer screen. Initializes instrument.

```
OUTPUT 718;"IP;"
```

```
OUTPUT 718;"V_AR?;"
```

The value of V_AR changes to its initial value after an IP.

VARDEF Variable Definition

```
ENTER 718;N  
PRINT N
```

Displays "0."

Description

The VARDEF command creates a user-defined variable and assigns it a value. User-defined variables can be used in many of the instrument remote-control processes. Use user-defined variables wherever "user-defined variable" appears in the syntax diagrams. An instrument preset (IP) sets user-defined variables to their initial value (see example).

An error results if a variable name is the same as any reserved word. Table 4-2 lists reserved words.

User-defined variables occupy instrument memory. Use the DISPOSE command to clear user-defined variables from memory.

VARIANCE

Variance of Trace Amplitudes

Returns the amplitude variance of the specified trace.

Syntax

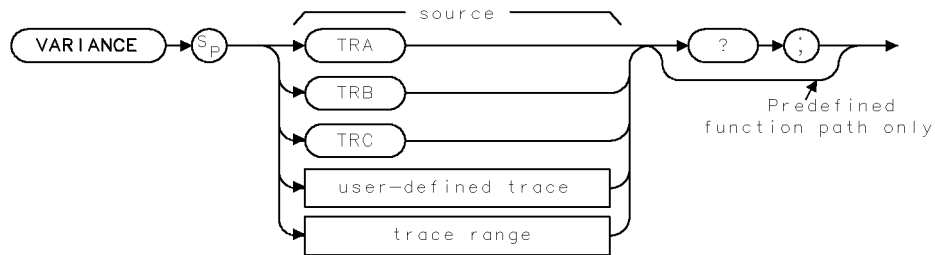

XVARIANCE

Item	Description/Default	Range
User-defined trace	A trace defined by the TRDEF command.	Any valid trace name.
Trace range	A segment of trace A, trace B, trace C, or a user-defined trace.	

Prerequisite Commands: TRDEF when using a user-defined trace. TS when using trace data.

Related Commands: MEAN, RMS

Example

OUTPUT 718;"IP;"	<i>Initializes instrument.</i>
OUTPUT 718;"SNGLS;TS;"	<i>Activates single-sweep mode.</i>
OUTPUT 718;"VARIANCE TRA?;"	<i>Returns variance of trace A to computer.</i>
ENTER 718;Number	<i>Stores value in computer variable.</i>
DISP Number;"MEASUREMENT UNITS"	<i>Displays the results on computer screen.</i>

Description

The VARIANCE command returns the amplitude variance of the specified trace, in measurement units. Taking the square root of a variance yields the standard deviation value.

VARIANCE Variance of Trace Amplitudes

The formula to calculate the variance is as follows:

$$\frac{\sum_{i=1}^n (\bar{x} - x_i)^2}{n - 1}$$

n represents the number of data points.

x_i represents a data point.

\bar{x} represents the mean of data.

Query Response

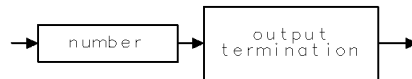

Q01

VAVG

Video Average

Enables the video-averaging function.

Syntax

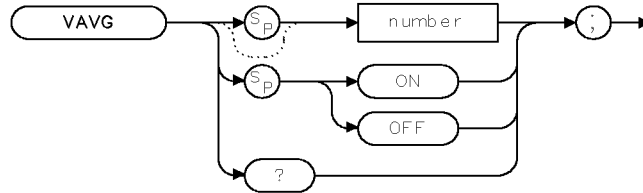

XVAVG

Item	Description/Default	Range
Number	Any valid integer. Default is 100.	1 to 16384.

Equivalent Softkeys: **VID AVG ON OFF**

Related Commands: AUTO, CLRAVG, IP, SMOOTH

Example

OUTPUT 718;"VAVG 150;" *Video averages the trace.*

Description

The VAVG command enables the video-averaging function, which averages trace points to smooth the displayed trace. Use VAVG to view low-level signals without slowing the sweep time. Video averaging can lower the noise floor by more than a 30 Hz average video bandwidth if a large number of sweeps has been specified for averaging. VAVG may also be used to monitor instrument state changes (for example, changing bandwidths, center frequencies) while maintaining a low noise floor. The active function readout indicates the number of sweeps to be averaged; the default for the number of sweeps is 100 unless otherwise specified. Executing "VAVG OFF;" turns off video averaging. Executing "VAVG ON;" turns on video averaging.

Query Response

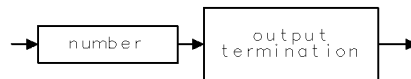

QQ1

VB Video Bandwidth

Specifies the video bandwidth.

Syntax

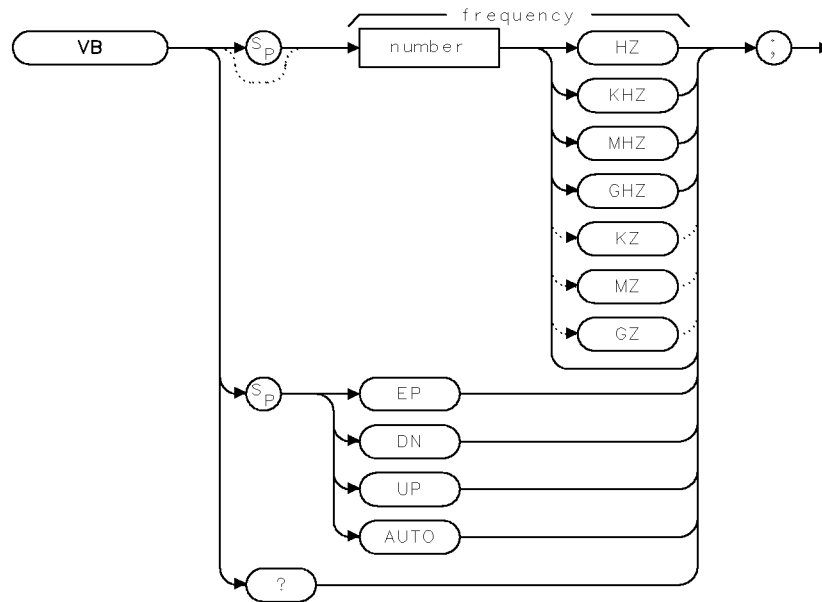

XVB

Item	Description/Default	Range
Number	Any real or integer number. Default unit is Hz.	30 Hz to 3 MHz.

Equivalent Softkeys: **AVG BW AUTO MAN**

Preset State: 1 MHz

Step Increment: In a 1, 3, 10 sequence

Related Commands: AUTO, AVBW, IFBW, RB, SP, ST, VBR

Example

OUTPUT 718;"VB 10KHZ;" *Changes the video bandwidth to 10 kHz.*

VB Video Bandwidth

Description

The VB command specifies the video bandwidth, which is a post-detection, low-pass filter. The resolution bandwidth, video bandwidth, and sweep time are normally coupled to the span. Executing VB uncouples video bandwidth from resolution bandwidth (it does nothing to the sweep-time, resolution-bandwidth, and span coupling). Executing AUTO recouples video bandwidth to the resolution bandwidth.

Frequency values other than the values in the 1, 3, 10 sequence are rounded to the nearest permissible value.

Query Response

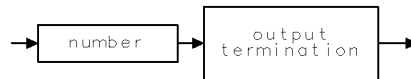

001

Note

Responses to “VB?” query are rounded to the closest whole number in Hertz. Therefore, the response to the “VB?” query may be incorrect in certain cases when the average detector is in use. Due to this situation we recommend using the AVBW command which does not have this limitation.

VBR Video Bandwidth Ratio

Determines the automatic setting of video bandwidth.

Syntax

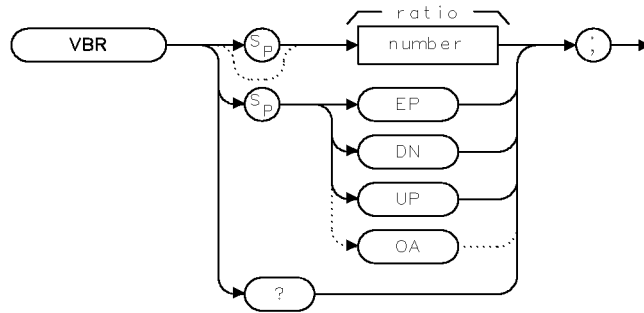

XVBR

Item	Description/Default	Range
Number	Any valid real number.	0 to 3000000

- Equivalent Softkeys: **AV/IF RATIO**
- Preset State: 0.300
- Step Increment: 1, 3, 10 sequence
- Related Commands: AUTO, AVBW, IFBW, RB, SP, VB

Example

```
OUTPUT 718;"VBR 1;"
```

Description

The VBR command determines the automatic setting of video bandwidth by multiplying the parameter by the resolution bandwidth. Ratio values other than the values in the 1, 3, 10 sequence are rounded to the nearest permissible value.

VBR returns a real number when used as a predefined variable.

Query Response

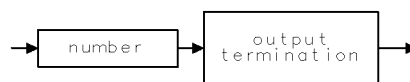

QQ1

VIEW

View Trace

Stops taking new data into the viewed trace.

Syntax

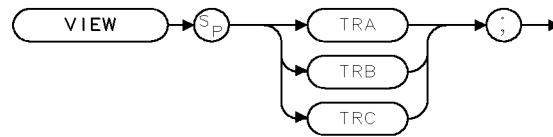

XVIEW

Equivalent Softkeys: `VIEW A`, `VIEW B`, and `VIEW C`

Related Commands: `BLANK`, `CLRW`, `MINH`, `MXMH`

Example

```
OUTPUT 718;"VIEW TRA;"
```

Description

The VIEW command displays trace A, trace B, or trace C, and stops taking new data into the viewed trace. In the VIEW mode the trace is not updated. When VIEW is executed, the contents of the trace are stored in display memory.

WAIT Wait

Suspends all instrument operation for the specified time duration.

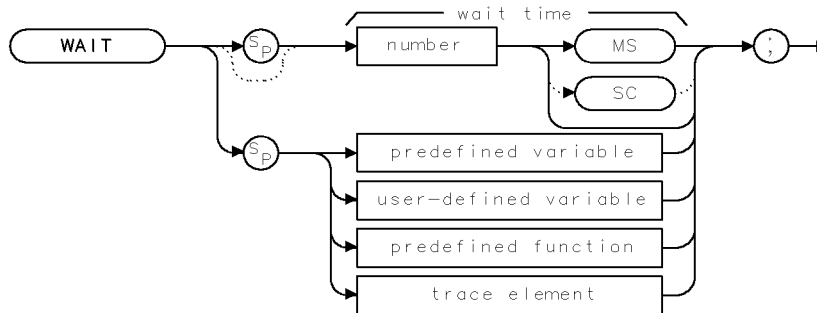

XWAIT

Item	Description/Default	Range
Number	Any real or integer number. Default unit is seconds.	1 ms to 1000 s.

Example

```

130 OUTPUT 718;"TRDSP TRA,OFF;TS;"    Blanks trace A.
140 OUTPUT 718;"WAIT 2SC;"           Suspends instrument operation for 2 seconds.
150 OUTPUT 718;"TRDSP TRA,ON;"       Displays trace A.
    
```

Description

The WAIT command suspends *all* instrument operation for the specified time.

WINNEXT

Window Next

Selects the upper or lower window as the active window.

Syntax

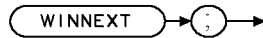

XWINNEXT .

Equivalent Key:

NEXT

Related Commands:

WINON, WINOFF

Example

```
OUTPUT 718;"WINON;"      Turns on the windows display mode.
OUTPUT 718;"WINNEXT;"   Selects the window that is currently not active to be the active
                        window.
```

Description

The WINNEXT command selects the upper or lower window as the active window. When the windows display mode is activated, there will be two windows displayed on the screen. Only one of the windows is active (the currently active window will have a highlighted line around the graticule). You can use the WINNEXT command to select the active window.

WINOFF Window Off

Turns off the windows display mode.

Syntax

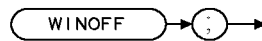

XWINOFF .

Equivalent Softkey: **WINDOWS OFF**

Related Commands: WINON

Example

```
OUTPUT 718;"WINON;"      Turns on the windows display mode.
OUTPUT 718;"WINNEXT;"    Selects the window that is currently not active to be the active
                          window.
OUTPUT 718;"WINOFF;"     Turns off the windows display mode.
```

Description

The WINOFF command turns off the windows display mode. When you execute WINON, there will be two windows displayed on the screen. You must execute WINOFF to turn the windows off and return to a single display, and the display will have the settings of the last active window. In contrast, WINZOOM also changes from two windows to one full screen display but does not exit the windows display mode; you can still access the second window by executing WINZOOM again.

WINON Window ON

Displays the two windows on the display.

Syntax

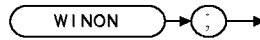

XWINON

Equivalent Key: **CTRL**

Related Commands: WINOFF, WINNEXT, WINZOOM

Example

```
OUTPUT 718;"WINON;"
```

Description

WINON activates the windows display mode and the zone marker.

Windows display mode:

When the windows display mode is first activated, there will be two windows displayed on the screen. Only one of the windows is active (the active window will have a highlighted line around the graticule). You can use the WINNEXT command to select the active window. The instrument state of the active window can be changed without affecting the state of the inactive window.

Zone marker:

The zone marker is shown in the upper window by two vertical lines. The frequency span between the two window. The zone marker can be moved and changed by using the ZMKCNTR, ZMKSPAN, ZMKPKNR, or ZMKPKNL programming commands. Changing the span or center frequency of the lower window will change the span or location of the zone marker on the upper window correspondingly.

Most programming commands can be executed when the windows display mode is used. Some functions cannot be used with the windows display mode, however. Table 4-9 lists the programming commands that, when executed, exit the windows display mode.

Table 4-9.
Programming Commands That Exit The Windows Display Mode

Command	Description
CAL	Performs the calibration routines.
IP	Performs an instrument preset.
LF	Performs an instrument preset into base band.

When in the windows display mode, saving the trace or state saves the state of the active window only. The recall state function recalls the stored state into the currently active window.

You must execute WINOFF to turn the windows off.

WINZOOM

Window Zoom

Expands the size of the window or displays both the upper and lower windows.

Syntax

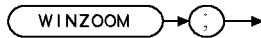

xWINZOOM

Equivalent Key: **ZOOM**

Related Commands: WINNEXT, WINON

Example

```
OUTPUT 718;"WINON;"      Turns on the windows display mode.  
OUTPUT 718;"WINZOOM;"   Expands the size of the active window.
```

Description

The WINZOOM command is used to either expand the size of the active window so that it fills the entire display, or display both the upper and lower windows on the display.

The first time WINZOOM is executed, it expands the active window. Executing WINZOOM again restores the windows display mode so that both of the windows are displayed on the display.

XCH Exchange

Exchanges the contents of sources 1 and 2.

Syntax

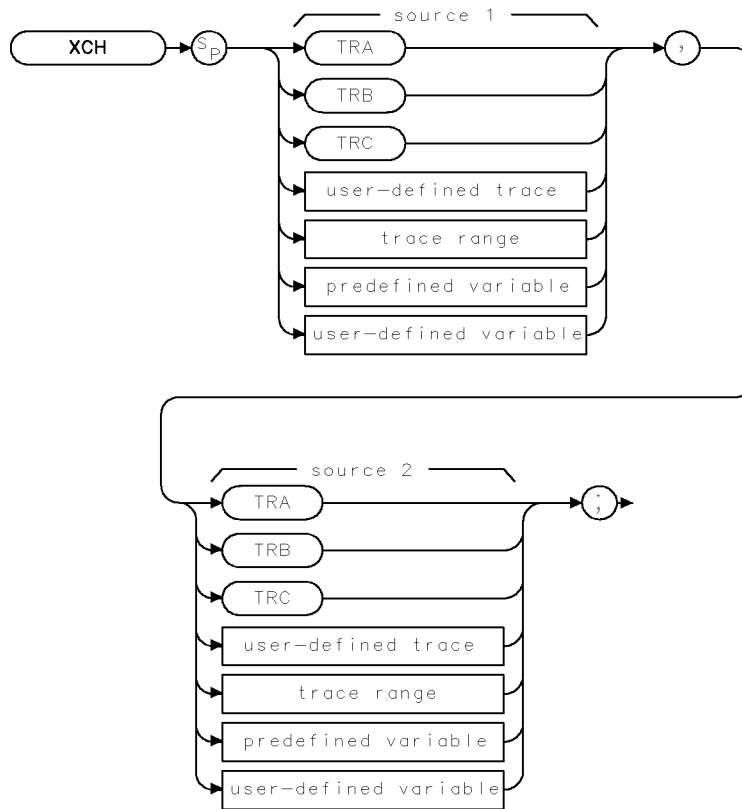

XXCH

Item	Description/Default	Range
User-defined trace	A trace defined by the TRDEF command.	Any valid trace name.
User-defined variable	A variable defined by VARDEF command.	Any valid variable name.
Predefined variable	A command that acts as a variable. Refer to Table 4-1.	
Trace range	A segment of trace A, trace B, trace C, or a user-defined trace.	

Prerequisite Commands: TRDEF when using a user-defined trace. VARDEF for a user-defined variable. TS when using trace data.

Related Commands: AXB, BXC

XCH Exchange

Example

OUTPUT 718; "XCH TRA,TRB;" *Exchanges the contents of trace A with trace B.*

Description

The XCH command exchanges the contents of sources 1 and 2. When the source is longer than the destination, the source is truncated to fit. When the source is shorter than the destination, the last element is repeated to fill the destination.

XUNITS Transducer Conversion Units

Selects the transducer conversion units for the AMPCOR correction factors.

Syntax

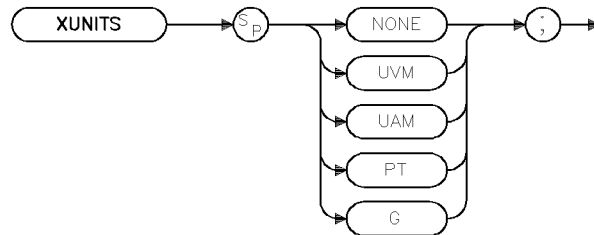

xxunits

Equivalent Softkey: Located under **Edit Units**

Related Commands: AMPCOR, AUNITS

Example

Description

The XUNITS command selects the transducer conversion units for the AMPCOR antenna correction factors. This specifies the units of the physical attribute to which an antenna actually responds and which will be indicated on the display for reference level, display line level, threshold level, and marker readouts.

The AMPCOR antenna correction factors are interpreted as a model of your antenna. They specify a conversion between the signal at the input and the actual electric or magnetic field sensed by the antenna.

For example, if your antenna produces a 3 μV signal in response to a 10 $\mu\text{V}/\text{meter}$ electric field at 400 MHz, the required correction is :

$$20 \text{ LOG } (10 / 3) = 10.46 \text{ dB}$$

specified by "AMPCOR ANTENNA,400e6,10.46" and the XUNITS setting is UVM.

Note When AMPCOR antenna correction factors are ON, the current XUNITS is used.
When AMPCOR antenna correction factors are OFF, the current AUNITS is used.

ZMKCNTR

Zone Marker at Center Frequency

Positions the zone marker at the specified frequency.

Syntax

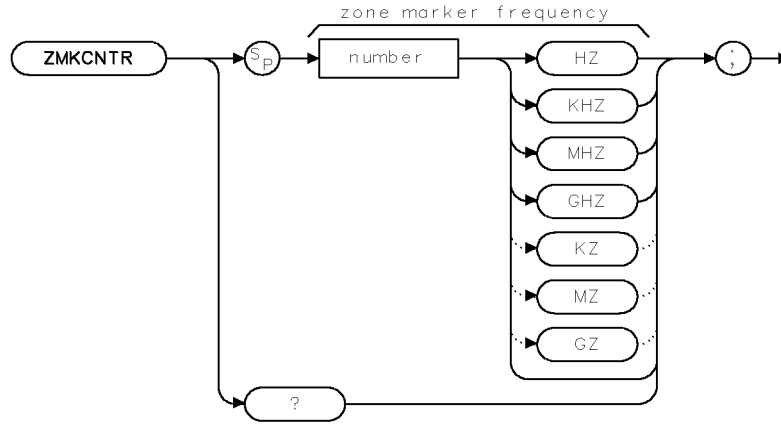

XZMKCNTR .

Item	Description/Default	Range
Number	Any real or integer number. Default unit is Hz.	Frequency range of the instrument.

Equivalent Softkey: **ZONE CENTER**

Default value: If a marker is onscreen, the frequency value of the marker. If a marker is not onscreen, the instrument center frequency.

Related Commands: CF, SP, WINON, ZMKSPAN

Example

OUTPUT 718; "WINON; " *Turns on the windows display mode.*
 OUTPUT 718; "ZMKCNTR 300MHZ; " *Places the zone marker at 300 MHz.*

Description

The ZMKCNTR command positions the marker at the specified frequency. ZMKCNTR allows you to move the zone marker within the frequency range displayed in the upper window. When the lower window is the active window, changing the center frequency (CF) or frequency span (SP) of the lower window changes the position of zone marker in the upper window.

ZMKCNTR Zone Marker at Center Frequency

Restrictions: Use ZMKCNTR only if the window is in non-zero span; ZMKCNTR does not apply if the window is in the time domain. The zone marker can be moved beyond the frequency range displayed by the upper window (the zone marker cannot exceed the frequency range of the instrument, however.) ZMKCNTR should only be used when the windows display mode is turned on.

You can use ZMKSPAN to change the span of the zone marker.

Query Response

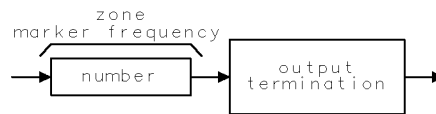

QZMKCNTR .

ZMKPKNL

Zone Marker for Next Left Peak

Places the zone marker at the next signal peak that is left of the zone marker's current position.

Syntax

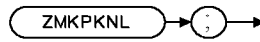

XZMKPKNL .

Equivalent Softkey: **ZONE PK LEFT**

Related Commands: MKPX, WINON, ZMKCNTR, ZMKSPAN, ZMKPKNR

Example

```
OUTPUT 718;"WINON;"      Turns on the windows display mode.
OUTPUT 718;"ZMKPKNL;"    Places the zone marker at the next peak to the left of the current
                          position of the zone marker.
```

Description

ZMKPKNL does the following:

1. Searches for the next signal peak outside and to the left of the zone marker. ZMKPKNL only applies if the window is in a non-zero span; ZMKPKNL does not apply if the window is in the time domain.
2. If a peak is found, ZMKPKNL moves the zone marker so that it is centered around the peak. If a signal peak cannot be found, or the window is in zero span, the zone marker is not moved.
3. Changes the center frequency of the lower window to the frequency of the signal peak.

To be considered a signal peak, the signal must be greater than the peak excursion (see "MKPX" for more information about the peak excursion).

ZMKPKNL should only be used when the windows display mode is turned on.

ZMKPKNR Zone Marker for Next Right Peak

Places the zone marker at the next peak to the right of the zone marker's current position.

Syntax

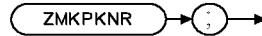

XZMKPKNR

Equivalent Softkey: **ZONE PK RIGHT**

Related Commands: MKPX, WINON, ZMKCNTR, ZMKSPAN, ZMKPKNL

Example

OUTPUT 718;"WINON;"	<i>Turns on the windows display mode.</i>
OUTPUT 718;"ZMKPKNR;"	<i>Places the zone marker at the next peak to the right of the current position of the zone marker.</i>

Description

ZMKPKNR does the following:

1. Searches for the next signal peak outside and to the right of the zone marker. ZMKPKNR only applies if the window is in a non-zero span; ZMKPKNR does not apply if the window is in the time domain.
2. If a peak is found, moves the zone marker so that it is centered around the peak. If a signal peak cannot be found, or the window is in zero span, the zone marker is not moved.
3. Changes the center frequency of the lower window to the frequency of the signal peak.

To be considered a signal peak, the signal must be greater than the peak excursion (see "MKPX" for more information about the peak excursion).

ZMKPKNR should only be used when the windows display mode is turned on.

ZMKSPAN

Zone Marker Span

Changes the width of the zone marker.

Syntax

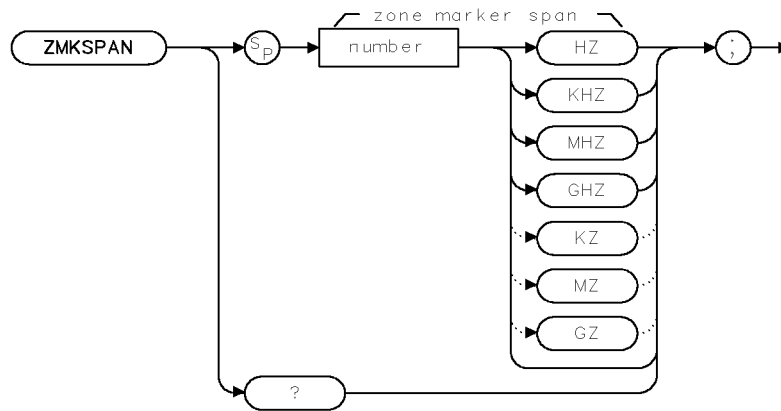

XZMKSPAN

Item	Description/Default	Range
Number	Any real or integer number. Default unit is Hz.	0 to maximum frequency span of the instrument.

Equivalent Softkey: **ZONE SPAN**

Default value: 1/10 of the frequency span of the instrument

Related Commands: SP, WINON, ZMKCNTR

Example

OUTPUT 718;"WINON;"

Turns on the windows display mode.

OUTPUT 718;"ZMKSPAN 100MHZ;"

Sets the span of the zone marker to 100 MHz.

Description

The ZMKSPAN command allows you to change the frequency span of the zone marker that is displayed in the upper window. When the lower window is the active window, frequency span (SP) of the lower window changes the frequency span of zone marker in the upper window.

Restrictions: Use ZMKSPAN only if the window is in non-zero span; ZMKSPAN does not apply if the window is in the time domain. ZMKSPAN should only be used when the windows display mode is turned on.

Query Response

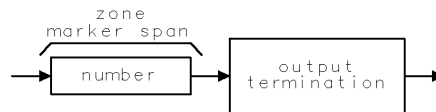

QZMKSPAN .

Error Messages

The instrument can generate various messages that appear on its screen during operation to indicate a problem.

There are three types of messages: hardware error messages (H), user-created error messages (U), and informational messages (M).

- Hardware error messages indicate the instrument hardware is probably broken.
- User-created error messages appear when the instrument is used incorrectly. They are usually generated during remote operation (entering programming commands using either a controller or the external keyboard).
- Informational messages provide information indicating the progress of the instrument within a specific procedure.

The messages are listed in alphabetical order on the following pages; each message is defined, and its type is indicated by an (H), (U), or (M).

ϕ LOCK OFF

Indicates slow YTO tuning. This message may appear if the instrument is using default correction factors. If this message appears constantly, perform the self-calibration routine to try to eliminate this message. ϕ LOCK OFF appears briefly during the self-calibration routine, during instrument preset, or when the frequency value is changed; this is normal and does not indicate a problem. (U) and (H)

ADC-2V FAIL

Indicates a hardware failure. (H)

ADC-GND FAIL

Indicates a hardware failure. (H)

ADC-TIME FAIL

Indicates a hardware failure. (H) and (U)

Bad device type in msus

An attempt has been made to read a disk that is neither LIF nor DOS format or a communication failure between the main processor and the floppy disk subsystem. If the disk in use is LIF or DOS format, try turning the instrument off, wait a few seconds, then turn the instrument on again. If the condition persists, contact your HP representative. (U) (H)

Bad mass storage parameter

May be reported if an attempt is made to read a disk that is neither LIF nor DOS format. Attempt a catalog operation on the disk or try a different disk. (U)

Bad mass storage volume label

May be reported if an attempt is made to read a disk that is neither LIF nor DOS format. Attempt a catalog operation on the disk or try a different disk. (U)

Bad mass storage volume spec

May be generated if the user removes media while it is being accessed or if a read or write

operation is attempted on unformatted media. Try the operation again or try the operation on media you are sure has been appropriately formatted.

Cal harmonic \geq 5.7 GHz NOT found *For an HP 8546A/HP 85462A only.*

Indicates that the CAL YTF routine cannot find a harmonic of the 300 MHz calibration signal. If this happens, perform the CAL FREQ and CAL AMP routines, and then perform the CAL YTF routine again. For the HP 8546A, press CAL ALL then perform the CAL YTF routine again. (U) and (H)

CAL: MAIN COIL SENSE FAIL

The instrument could not set up span sensitivity of the main coil. If this message appears, press (FREQUENCY), CENTER FREQ, -37, (Hz), (CALIBRATE), More 1 of 3, More 2 of 3, DEFAULT CAL DATA, and perform the self-calibration routine again. (H)

CAL: NBW 200 Hz notch amp failed

Indicates that the 200 Hz IF bandwidth is not the correct shape for the calibration routine. (H)

CAL: NBW 200 Hz notch failed

Indicates that the 200 Hz IF bandwidth is not the correct shape for the calibration routine. (H)

CAL: NBW 200 Hz width failed

Indicates that the 200 Hz IF bandwidth is not the correct bandwidth for the calibration routine. (H)

CAL: NBW gain failed

Indicates that one of the IF bandwidths is not the correct amplitude for the calibration routine. (H)

CAL: NBW width failed

Indicates that one of the IF bandwidths is not the correct width for the calibration routine. (H)

CAL: PASSCODE NEEDED

Indicates that the function cannot be accessed without the pass code. For the DEFAULT CAL DATA function, the pass code is setting the center frequency of the instrument to -37 Hz. (M)

CAL: RES BW AMPL FAIL

The relative insertion loss of the IF bandwidth is incorrect. This message also sets SRQ 110. (H)

CAL SIGNAL NOT FOUND

Indicates the calibration signal cannot be found. Check that the instrument input connectors are connected properly. If the calibration signal is connected properly but cannot be found, press (FREQUENCY), CENTER FREQ, -37, (Hz), (CALIBRATE), More 1 of 3, More 2 of 3, DEFAULT CAL DATA. If the calibration signal still cannot be found, press (FREQUENCY), CENTER FREQ, -37, (Hz) and perform the CAL FREQ and CAL AMP (receiver RF section) or CAL ALL (EMI receiver) self-calibration routines. This message also sets SRQ 110. (U) and (H)

CAL: SPAN SENS FAIL

The self-calibration span sensitivity routine failed. This message also sets SRQ 110. (H)

CAL: USING DEFAULT DATA

Indicates that the calibration data is corrupt and the default correction factors are being used. Interruption of the self-calibration routines or an error can cause this problem. (M)

CAL YTF FAILED *For an HP 8546A/HP 85462A only.*

Indicates that the CAL YTF routine could not be successfully completed. Perform the self-calibration routines, then perform the CAL YTF routine again. (U) and (H)

CAL: ZERO FAIL

The instrument could not set up the tuning sensitivity of the main coil. If this message appears, press (FREQUENCY), CENTER FREQ, -37, (Hz), (CALIBRATE), More 1 of 3, More 2 of 3, DEFAULT CAL DATA, and perform the self-calibration routines again. (H)

Cannot engage phase lock with current CAL FREQ data

Indicates that the CAL FREQ routine needs to be performed before phase locking can be turned on. (U)

Cannot BYPASS Input 1

An attempt was made to execute the BYPASS command while the signal path is routed through INPUT 1 of the RF filter section. Only INPUT 2 of the RF filter section can be bypassed.

Checkread error

This error may be due to conflicting disk operations invoked from the front-panel keys and the remote I/O port, or it may indicate that the disk is corrupt. After pressing the "HOLD" key, (ENTER), on the front panel, retry the operation. If the operation fails again, check the disk using the catalog function. (U)

COMMAND ERROR: _ _ _

The specified programming command is not recognized by the instrument. (U)

Configuration Error

This error indicates a serious problem in the ability of the instrument to use the floppy disk drive. Try presetting the instrument. If the condition persists, contact your HP representative. (H)

CONF TEST FAIL

Indicates that the confidence test failed. Perform the self-calibration routines, and then perform the confidence test again. This message also sets SRQ 110. (H) and (U)

Directory not empty

Reported if an attempt is made to purge a non-empty directory. Ensure that all files in any directory have been purged or moved before attempting to purge the directory. (U)

Directory overflow

Reported if the disk directory runs out of room. Change the media. (M)

Drive not found or bad address

An attempt has been made to read a disk that is neither LIF nor DOS format or a communications failure between the main processor and the floppy disk subsystem. If the disk in use is LIF or DOS format, try turning the instrument off, wait a few seconds, then turn the instrument on again. If the condition persists, contact your HP representative. (U) (H)

Duplicate file name

Reported if the file system tries to write data to a file that already exists, but did not exist previously. May be due to changing media just before an operation attempts to create a new file. (U)

Duplicate file name, PROTECT is on

Reported if the user attempts to overwrite a previously existing file with PROTECT status set to ON (the default state). Use a different file name, purge the file, or turn off the PROTECT feature. (U)

End of file or buffer found

Reported if an attempt is made to read or write beyond the current file or directory is made. Also reported if an attempt is made to add files to a directory that is already full. Try using a new disk. (U)

End of rec found, random mode

Reported if an attempt is made to read or write beyond the current record being accessed. Try the operation again. (U)

FAIL: _ _ _

An error was discovered during the power-up check. The 4-digit by 10-digit code indicates the type of error. (H)

File name is undefined

May be reported if the user changes media immediately before a read operation is attempted on a file of a specific name. Ensure that the file exists on the disk by using the catalog feature. (U)

File not currently assigned

May be generated if the user removes media while it is being accessed. Try the operation again. (U)

File open on target device

May be due to conflicting file operations invoked simultaneously from the front-panel keys and the remote I/O port. Attempt the operation again. (U)

File type incompatible

Indicates that the selected file is not a display image file. The file name for a display image file is always preceded by an "i." (U)

FREQ UNCAL

The FREQ UNCAL message appearing constantly, indicates a YTO-tuning error. Perform the CAL FREQ (receiver RF section) or CAL ALL (EMI receiver) routines. (U) and (H)

Function not available in current Mode

Indicates that the function that you have selected can only be used with the instrument mode. You can use the (MODE) key to select the instrument mode. (U)

HFS disc may be corrupt

This error may be due to conflicting disk operations invoked from the front-panel keys and the remote I/O port, or it may indicate that the disk is corrupt. After pressing the "HOLD" key, (ENTER), on the front panel, retry the operation. If the operation fails again, check the disk using the catalog function. (U)

Improper destination type

Reported if an attempt is made to append data to a file and the file cannot be extended. Try the operation using another disk. (U)

Improper file name

Reported if a file or directory name is specified that in some manner does not conform to file name conventions: too many characters, illegal character in file name, and so on.

Improper file type

Reported in the event that an operation appropriate for a data file is attempted on a directory. Check the contents of the disk using the catalog function. (U)

Improper value or out of range

Indicates an internal error in computing the amount of data to read from the disk or an invalid parameter. This may indicate corrupt media; try a new disk. If the condition persists, contact your HP representative. (H)

Incorrect unit code in msus

An attempt has been made to read a disk that is neither LIF nor DOS format or a communications failure between the main processor and the floppy disk subsystem. If the disk in use is LIF or DOS format, try turning the instrument off, wait a few seconds, then turn the instrument on again. If the condition persists, contact your HP representative. (U) (H)

Incorrect volume code in msvs

An attempt has been made to read a disk that is neither LIF nor DOS format or a communications failure between the main processor and the floppy disk subsystem. If the disk in use is LIF or DOS format, try turning the instrument off, wait a few seconds, then turn the instrument on again. If the condition persists, contact your HP representative. (U) (H)

Insufficient Memory

Indicates a temporary memory overflow condition. Attempt to free memory that may have been temporarily allocated by performing the following steps:

1. If there is a disk catalog on the display, exit the catalog.
2. Execute the dispose softkeys under **Dispose User Mem** in the **CONFIG** menu. (U)

INTEGER overflow

Indicates a computation error during disk access. This may indicate corrupt media; try a new disk. If the condition persists, contact your HP representative. (H)

Internal error

Indicates a failure of the floppy disk controller or a failure in communications between the main processor and the floppy disk controller. Try turning the instrument off, wait a few seconds, then turn the instrument on again. If the condition persists, contact your HP representative. (H)

INTERNAL LOCKED

The internal trace and state registers of the instrument have been locked. To unlock the trace or state registers, press **SAVE**, **Save Internal**, **SAV LOCK ON OFF** so that OFF is underlined. (U)

INVALID AMPCOR: FREQ

For the AMPCOR command, the frequency data must be entered in increasing order. See the description for the AMPCOR programming command for more information. (U)

INVALID ENTER FORMAT

The enter format is not valid. See the appropriate programming command description to determine the correct format. (U)

INVALID <file name> NOT FOUND

Indicates that the specified file could not be loaded into internal memory or purged from memory because the file name cannot be found. (U)

INVALID FILENAME _ _ _

Indicates the specified file name is invalid. A file name is invalid if there is no file name specified, if the first letter of the file name is not alphabetic, or if the specified file type does not match the type of file. See the description SAVRCLW or STOR programming commands for more information. (U)

INVALID FILE: NO ROOM

Indicates that there is insufficient space available on the floppy disk to store the data. (U)

INVALID HP-IB ADRS/OPERATION

An HP-IB operation was aborted due to an incorrect address or invalid operation. Check that there is only one controller (the EMI receiver) connected to the printer or plotter. (U)

INVALID HP-IB OPERATION REN TRUE

The HP-IB operation is not allowed. (This is usually caused by trying to print or plot when a controller is on the interface bus with the instrument.) To use the instrument print or plot functions, you must disconnect any other controllers on the HP-IB. If you are using programming commands to print or plot, you can use an HP BASIC command instead of disconnecting the controller. See the description for the PRINT command for more information. (U)

INVALID ITEM: _ _ _

Indicates an invalid parameter has been used in a programming command. (U)

INVALID KEYLBL: _ _ _

Indicates that the specified key label contains too many characters. A key label is limited to 8 printable characters per label line. (U)

INVALID KEYNAME: _ _ _

The specified key name is not allowed. (The key name may have conflicted with a instrument programming command.) To avoid this problem, use an underscore as the second character in the key name, or avoid beginning the key name with the following pairs of letters: LB, OA, OL, TA, TB, TR, MA, MF, TS, OT, and DR. (U)

INVALID OUTPUT FORMAT

The output format is not valid. See the appropriate programming command description to determine the correct format. (U)

INVALID RANGE: Stop < Start

Indicates that the first trace element specified for a range of trace elements is larger than ending trace element. When specifying a trace range the starting element must be less than the ending element. For example, TRA[2,300] is legal but TRA[300,2] is not. (U)

INVALID REGISTER NUMBER

The specified trace register number is invalid. (U)

INVALID RS-232 ADRS/OPERATION

An RS-232 operation was aborted due to an invalid operation. (U)

INVALID SAVE REG

Data has not been saved in the specified state or trace register, or the data is corrupt. (U)

INVALID SCRMOVE

Indicates the instrument may have a hardware failure. (H)

INVALID START INDEX

Indicates that the first trace element specified for a range of trace elements is not within the trace range of the specified trace. (U)

INVALID STOP INDEX

Indicates that the ending trace element specified for a range of trace elements is not within the trace range of the specified trace. (U)

INVALID TRACE: _ _ _

The specified trace is invalid. (U)

INVALID VALUE PARAMETER: _ _ _

The specified value parameter is invalid. (U)

INVALID WINDOW TYPE: _ _ _

The specified window is invalid. See the description for the TWINDOW programming command. (U)

LOST SIGNAL

This message indicates that an internal hardware connection problem exists. (H)

LO UNLVL

Indicates that the local oscillator in the EMI receiver distribution amplifier is not functioning properly. (H)

Marker Count Reduce SPAN

Indicates the IF bandwidth to span ratio is too small to use the marker count function. Check the span and IF bandwidth settings. (U)

Marker Count Widen RES BW

Indicates that the current IF bandwidth setting is too narrow to use with the marker counter function. The marker counter function can be in narrow IF bandwidths (bandwidths that are less than 1 kHz) with the following procedure:

1. Place the marker on the desired signal.
2. Increase the IF bandwidth to 1 kHz and verify the marker is on the signal peak.
3. If the marker is on the signal peak, the marker count function can be used in either the 1 kHz IF bandwidth or the original narrow IF bandwidth setting. If the marker is not on the signal peak, it should be moved to the signal peak and the marker counter function should not be used with a IF bandwidth setting of less than 1 kHz. (U)

Mass storage hardware failure

Indicates a failure of the floppy disk controller or a failure in communications between the main processor and the floppy disk controller. Try turning the instrument off, wait a few seconds, then turn the instrument on again. If the condition persists, contact your HP representative. (H)

Mass storage medium overflow

Reported when a disk has no more room available to write data. Try a new disk. (U)

Mass storage system error

Indicates a failure of the floppy disk controller or a failure in communications between the main processor and the floppy disk controller. Try turning the instrument off, wait a few seconds, then turn the instrument on again. If the condition persists, contact your HP representative.

Mass storage volume not present

An attempt has been made to read a disk that is neither LIF nor DOS format or a communications failure between the main processor and the floppy disk subsystem. If the disk in use is LIF or DOS format, try turning the instrument off, wait a few seconds, then turn the instrument on again. If the condition persists, contact your HP representative. (U)
(H)

MEAS UNCAL

The measurement is uncalibrated. Check the sweep time, span, and bandwidth settings, or press **(AUTO COUPLE)**, **AUTO ALL**. (U)

Medium changed or not in drive

Reported if disk is removed during disk access cycle. Try the operation without removing the disk. (U)

Medium uninitialized

Indicates that a file operation has been attempted on an uninitialized disk, or on a disk that is neither LIF nor DOS format. Be sure that any disk on which file operations are attempted is properly formatted. The format softkeys, in the **(CONFIG)** menu, may be used to format a disk, but any information on the disk will be erased during the formatting process. (U)

No points defined

Indicates the specified limit line or amplitude correction function cannot be performed because no limit line segments or amplitude correction factors have been defined. (U)

Operation failed on some files

Reported if, during a purge operation on a file specifier that contains wildcards, the number of files actually purged does not match the original number of files found that match the file specifier. Check the disk using the catalog function. (U)

Operation not allowed on open file

May be due to conflicting file operations invoked simultaneously from the front-panel keys and the remote I/O port. Attempt the operation again. (U)

OVEN COLD

Indicates that the EMI receiver has been powered up for less than 5 minutes. (The actual temperature of the precision frequency oven is not measured.) (M)

PARAMETER ERROR: _ _ _

The specified parameter is not recognized by the instrument. See the appropriate programming command description to determine the correct parameters. (U)

PASSCODE NEEDED

Indicates that the function cannot be accessed without the pass code. (U)

Permission denied

Indicates that a file write-operation was attempted on either a read-only file or on a directory. Check the disk using the catalog function and try the operation on an appropriate file again. (U)

Possibly corrupt file

This error may be due to conflicting disk operations invoked from the front-panel keys and the remote I/O port, or it may indicate that the disk is corrupt. After pressing the "HOLD" key, **(ENTER)**, on the front panel, retry the operation. If the operation fails again, check the disk using the catalog function. (U)

POS-PK FAIL

Indicates the positive-peak detector has failed. (H)

RCVR Limits not allowed in SA mode

This error is encountered when an attempt is made to enable limit-line display, limit-margin display, or limit testing of limits defined in Receiver mode when the instrument is operating in Signal Analysis mode. To correct the problem, either purge the limits or switch to Receiver mode. (U)

Read data error

This error may be due to conflicting disk operations invoked from the front-panel keys and the remote I/O port, or it may indicate that the disk is corrupt. After pressing the "HOLD" key, **(ENTER)**, on the front panel, retry the operation. If the operation fails again, check the disk using the catalog function. (U)

Record address error

This error may be due to conflicting disk operations invoked from the front-panel keys and the remote I/O port, or it may indicate that the disk is corrupt. After pressing the "HOLD" key, **(ENTER)**, on the front panel, retry the operation. If the operation fails again, check the disk using the catalog function. (U)

Record not found

This error may be due to conflicting disk operations invoked from the front-panel keys and the remote I/O port, or it may indicate that the disk is corrupt. After pressing the "HOLD" key, **(ENTER)**, on the front panel, retry the operation. If the operation fails again, check the disk using the catalog function. (U)

REF UNLOCK

Indicates that the frequency reference is not locked to the external reference input. Check that the 10 MHz REF OUTPUT connector is connected to the EXT REF IN connector, or,

when using an external reference, that an external 10 MHz reference source of sufficient amplitude is connected to the EXT REF IN connector. (U) and (H)

Require 1 signal > PEAK EXCURSION above THRESHOLD

Indicates that the N dB PTS routine cannot locate a signal that is high enough to measure. The signal must be greater than the peak excursion above the threshold level to measure. (U)

Require 3 signals > PEAK EXCURSION above THRESHOLD

Indicates that the % AM routine cannot locate three signals that are high enough to measure. The signals must be greater than the peak excursion above the threshold level to measure. (U)

Require 4 signals > PEAK EXCURSION above THRESHOLD

Indicates that the TOI routine cannot locate four signals that are high enough to measure. The signals must be greater than the peak excursion above the threshold level to measure. (U)

Required option not installed

Some instrument functions require that an option be installed in the instrument. See the description for the function in the User's Guide for more information about which option is required. (U)

RF Filter Section Absent

This message is displayed if the bypass command is executed when the RF filter section is not connected to, or is not communicating with, the receiver RF section. (U) and (H)

RFFS Error: COMMAND

The RF filter section has received a command that it does not recognize. Assure that there is no cable connected to the RF filter section Service Bus interface. If the condition persists, and there is no cable connected to the RF filter section Service Bus interface, contact your HP representative. (U)

RFFS Error: HARDWARE

The RF filter section has experienced a hardware failure. If the condition persists after presetting the instrument or cycling power, contact your HP representative. (H)

RFFS Error: TIMEOUT

Communication failure between the receiver RF section and the RF filter section. Check power to the RF filter section and check that the AUX interface cable is properly connected between both instruments. (U) (H)

RFFS Service Bus Active

This message appears in the active function area of the receiver RF section display when an external controller communicates with the RF filter section via the RF filter section Service Bus interface. (H)

RF PRESEL ERROR *For an HP 8546A/HP 85462A only.*

Indicates that the preselector peak routine cannot be performed. (H)

RF PRESEL TIMEOUT *For an HP 8546A/HP 85462A only.*

Indicates that the preselector peak routine cannot be performed. (H)

SA Limits not allowed in RCVR mode

This error is encountered when an attempt is made to enable limit-line display, limit-margin display, or limit testing of limits defined in Signal Analysis mode when the instrument is operating in Receiver mode. To correct the problem, either delete the limits or switch to Signal Analysis mode. (U)

SAMPLE FAIL

Indicates the sample detector has failed. (H)

SIGNAL CLIPPED

Indicates that the current FFT measurement sweep resulted in a trace that is above the top graticule line on the display. If this happens, the input trace (trace A) has been “clipped,” and the FFT data is not valid. (U)

Signal not found

Indicates the PEAK ZOOM routine did not find a valid signal. (U)

Signals do not fit expected % AM pattern

Indicates that the % AM routine cannot perform the percent AM measurement because the onscreen signals do not have the characteristics of a carrier with two sidebands. (U)

Signals do not fit expected TOI pattern

Indicates that the TOI routine cannot perform the third-order intermodulation measurement because the onscreen signals do not have the characteristics of two signals and two distortion products. (U)

SMPLR UNLCK

Indicates that the sampling oscillator circuitry is not functioning properly. If this message appears, check that the external frequency reference is correctly connected to the EXT REF INPUT. (U) and (H)

SOFTKEY OVFL

Softkey nesting exceeds the maximum number of levels. (U)

SRQ - - -

The specified service request is active. (M)

STEP GAIN/ATTN FAIL

Indicates the step gain has failed. (H)

TABLE FULL

Indicates the upper or lower table of limit lines contains the maximum number of entries allowed. Additional entries to the table are ignored. (U)

TG SIGNAL NOT FOUND

Indicates the tracking generator output signal cannot be found. For the receiver RF section, check that the TRACKING GENERATOR OUTPUT is connected to the RF INPUT connector with an appropriate cable. For the EMI receiver, check that the cable between the TRACKING GENERATOR OUTPUT and TRACKING GENERATOR is properly connected. (U)

TG UNLVL

This message can indicate the following: that the source power is set higher or lower than the instrument can provide, that the frequency span extends beyond the specified frequency range of the tracking generator, or that the calibration data for the tracking generator is incorrect. (U)

Too many open files

This error may be due to conflicting disk operations invoked from the front-panel keys and the remote I/O port, or it may indicate that the disk is corrupt. After pressing the “HOLD” key, **(ENTER)**, on the front panel, retry the operation. If the operation fails again, check the disk using the catalog function. (U)

Too many signal with valid N dB points

Indicates the N dB PTS function has located two or more signals that have amplitudes within the specified dB from the signal peak. If this happens, you should decrease the span of the instrument so that only the signal that you want to measure is displayed. (U)

Trace A is not available

Indicates that trace A is in the store-blank mode and cannot be used for limit-line testing.

Use **CLEAR WRITE A** or **VIEW A** to change trace A from the store-blank mode to the clear write mode, and then turn on limit-line testing. (U)

Unable to replace file

Reported if an attempt is made to append data to a file and the file cannot be extended. Try the operation using another disk. (U)

USING DEFAULTS self cal needed

Indicates that the current correction factors are the default correction factors and that the self-calibration routines need to be performed. For either an HP 8546A or an HP 85462A, also perform the **CAL YTF** self-calibration routine. (U)

VID-BW FAIL

Indicates the averaging bandwidths have failed. (H)

Wildcard matches > 1 item

An attempt was made to use the wildcard matching character on an operation that requires a specific file name. For example, an attempt to load from a file name that contains a wildcard character. Try the operation using a specific file name. (U)

Wildcards not allowed

An attempt was made to use the wildcard matching character on an operation that requires a specific file name. For example, an attempt to load from a file name that contains a wildcard character. Try the operation using a specific file name. (U)

Write protected

Indicates that a write operation was attempted on a disk that is write protected. Move the write-protect tab on the floppy disk to the unprotected position, reinsert the disk in the disk drive and attempt the operation again. (U)

Nonrecoverable System Errors

Certain situations can create error conditions from which the main processor cannot recover. In the event that the processor detects a nonrecoverable error, the instrument will be initialized, the display will be blanked, and special error messages will be written to the display.

The following is a sample nonrecoverable system error message display.

```
System Error 4, HP 8546A, SN 4
13:18:20 DEC 13, 1993, Rev: 931210
  SR: 0000      PC: 00FFB370      00FF6F1E:      00009300
D0: 00000000   A0: 00FFB238      00FF6F22:      00000000
D1: 00000000   A1: 00FF803E      00FF6F26:      00000000
D2: 00FFB238   A2: 00FF803C      00FF6F2A:      00FF803E
D3: 00FF803E   A3: 00FFB2FE      00FF6F2E:      000031B1
D4: 00008E7D   A4: 00FFB2F4      00FF6F32:      0004065E
D5: 00FF80ES   A5: 00FC6948      00FF6F36:      0004EDES
D6: 00FFB39A   A6: FFFFFFFF      00FF6F3A:      00FF8000
D7: 00FFB392   A7: 00FF6F1E      00FF6F3E:      00FF88AE
                                00FF6F42:      00FF87E0
                                00FF6F46:      00FFB03C
                                00FF6F4A:      000C9AEA
                                00FF6F4E:      00FF8890
                                00FF6F52:      040800FF
                                00FF6F56:      000900FF
                                00FF6F5A:      B23A0000

WARNING: Config Settings Defaulted
        Press COPY to print error report and
        advise your local HP representative
Press PRESET to resume operation
```

When a nonrecoverable error message is displayed, the instrument will only respond to the front-panel COPY and PRESET keys. If you have a printer configured and connected to the instrument, and if no remote controller is currently connected to the I/O port through which the printer is connected, you can generate a hardcopy of the diagnostic part of the error message by pressing the front-panel COPY key.

In order to resume instrument operation following a nonrecoverable system error, press the front-panel PRESET key. The instrument will resume operation from its preset state.

Among the conditions which can contribute to the occurrence of a nonrecoverable system error are:

- Hardware failure of the main processor
- Hardware failure of system memory available to the main processor
- Errors in the primary system control program
- Attempted execution of unsupported system commands

Nonrecoverable system errors may occur when attempting to load an improper file type into the machine. For example, loading a file with an incorrect format into a limit line or amplitude correction table may generate this error.

If nonrecoverable system errors occur regularly, contact your HP representative.

HP-IB

This appendix tells you how to connect a computer to your EMI receiver or receiver RF section with the Hewlett-Packard Interface Bus (HP-IB).

Your instrument has an HP-IB connector on the rear panel, as shown in Figure A-1.

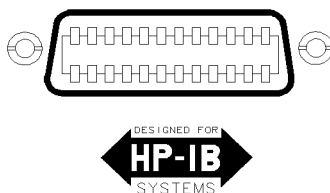

cu17e

Figure A-1. HP-IB Connector

The HP-IB system utilizes a party-line bus structure. Devices such as your instrument are connected on the party line with HP-IB cables. A computer gives instructions and is the “controller.” The instrument takes orders and is the “listener.” The instrument is also capable of transmitting data over the party line. Devices that transmit data back to the computer are “talkers.”

Each device on the party line has an address. Device addresses are used by the controller to specify who talks and who listens. A device’s address is usually set at the factory.

The number 7 preceding the device’s address (for example, Instrument=718), signifies that the HP-IB interface is selected.

When you turn on the instrument, the HP-IB address appears on the screen (for example, HP-IB ADRS: 18). If necessary, you can reset the address of the instrument by pressing **(CONFIG)**, **More 1 of 3**, **RECEIVER ADDRESS**, entering in the address number using the front-panel number keys, then pressing **(ENTER)**. You may use any address between 0 and 30. (Usually, 1 is reserved for printers and 5 for plotters.)

RS-232 Option 023

What You'll Learn in This Appendix

This appendix explains how to connect a computer to your EMI receiver or receiver RF section using the RS-232 interface. It contains information pertaining to RS-232 signals, cable connections, and baud rate.

Introducing the RS-232 Interface

Your instrument has an RS-232 connector on the rear panel, as shown in Figure B-1.

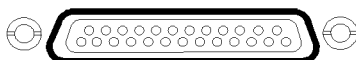

cu18e

Figure B-1. RS-232 Connector

The RS-232 interface utilizes serial data transmission. Data is sent, one bit at a time, in groups of 10 to 12 data-bits.

Two devices, such as the instrument and a computer, can exchange commands and data over the RS-232 connection. This interface uses two serial data lines and five handshaking lines. Handshaking signals are required for full hardware control of the information exchange. It is possible to use a three-wire connection, in some situations.

Another parameter for the RS-232 interface is the “baud,” or data rate. This is the speed at which the computer and instrument exchange data. The baud rate of each of the two RS-232 devices must be the same.

The RS-232 Data Lines

RS-232 uses serial data transmission, meaning that data is transmitted one bit at a time. There are two data lines carrying signals:

- Transmit data (TxD)—the serial data output. This line is connected to the RxD input line.
- Receive data (RxD)—the serial data input. This line is connected to the TxD output line.

The RS-232 Handshaking Lines

In addition to the data signals, there are five other signals lines (called handshaking lines), used to control the flow of data. Listed below are the handshake signal descriptions:

- Request to send (RTS)—Output signal indicates that the instrument is ready to communicate. This line is true at power-up and stays true while power is on.
- Clear to send (CTS)—Input signal indicates that the external controller is ready to receive data.

- Data terminal ready (DTR)—Output signal from the instrument. When the input buffer is full, this line goes false.
- Data set ready (DSR)—Is not available.
- Data carrier detect (DCD)—Input to the instrument. If DCD is true, the instrument will receive data from the controller. If false, no data will be input. The data will be ignored.

The instrument checks its CTS input before transmitting data to the computer. If the CTS line is false, the instrument will not transmit data. The instrument transmits data when the CTS line is true.

The instrument sets the DTR line (PC CTS) false when its input buffer is full.

Baud Rate

The speed at which data is exchanged is called the baud rate or data rate. This is usually expressed in baud or bits per second. Common baud rates are 1200 and 9600.

Note Some of the programs in this manual use 1200 baud for proper operation. If your system uses the RS-232 handshake lines, you can use 9600 baud for all of the programs.

If you need to change the baud rate, refer to the “Setting the Instrument Baud Rate” in this appendix.

Protocol

The RS-232 protocol is as follows:

- Baud rate 300 to 57,000 baud
- 8 bits per character
- 1 stop bit
- No parity
- Software handshake—none
- Xon/Xoff and ENQ/ACK not supported by the instrument

When BREAK is issued to the instrument, the following occurs:

1. The present command is aborted.
2. The input buffer is cleared.
3. The output buffer is cleared.
4. All trace output is stopped.
5. The command parser is reinitialized.

BREAK does not perform any of the following:

- Invoke instrument preset.
- Clear SRQ off screen.
- Clear illegal command off screen.

The RTS signal goes true on power-up and does not go false during any communication. It stays true while power is on.

Figure B-2 lists the signal connections between a personal computer and the instrument.

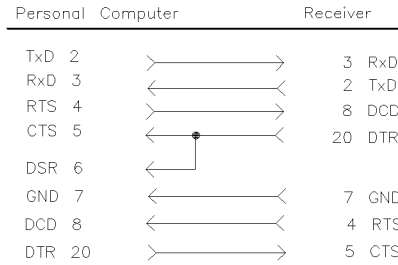

cu19e

Figure B-2. Full Handshaking Connection

If your computer operates with only three wires, you can use the cable connections in Figure B-3.

Some computers require that the CTS, DSR, and DCD inputs be true before serial transmission can occur. To solve this problem, you can wire these three signals to the personal computer RTS line.

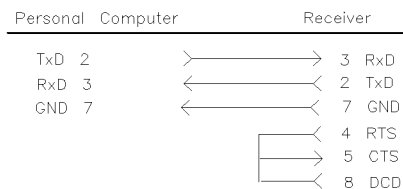

cu110e

Figure B-3. 3-Wire Connection

Connecting a ThinkJet Printer

To connect an HP ThinkJet printer to the instrument, use the information in Figure B-4, Table B-1, Table B-2, and Table B-3. Be sure to turn the printer off and then back on *after* changing the printer settings. See the ThinkJet Printer Manual for more information.

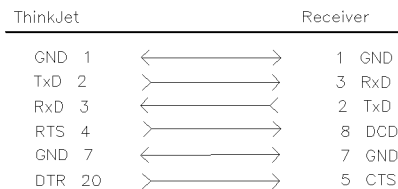

cu111e

Figure B-4. ThinkJet Printer Connection

ThinkJet Printer Mode Switches:

Table B-1. Setting of Thinkjet Printer Mode Switches

Switch Number	Setting	Comments
1	down	Printer performs a carriage return only.
2	down	Printer performs a line feed only.
3	up	Sets the printer to skip paper perforations.
4	down	Sets the printer for a paper length of 11 inches.
5	down	Sets the printer to HP MODE.
6	up	Sets the printer to USASCII.
7	down	
8	down	

Table B-2. Setting of RS-232 Switches

Switch Number	Setting	Comments
1	up	DTR.
2	down	no parity, 8 bits.
3	down	
4	down	9600 baud.
5	down	

Table B-3. Setting the Baud Rate

Baud Rate	Setting for Switch 4	Setting for Switch 5
1200	up	up
2400	up	down
9600	down	down

Connecting a Modem

To connect a modem to the instrument, use the information in Figure B-5. The connection is for a Hayes 1200 Modem and the instrument.

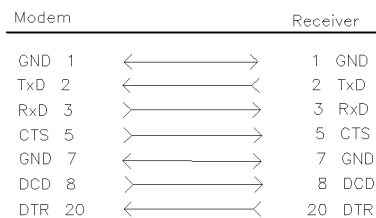

cu112e

Figure B-5. Modem Connection

System Settings

Select 1200 baud for both the modem and the instrument.

Connecting an HP-GL Plotter

To connect an HP-GL plotter to the instrument, use the information in Figure B-6.

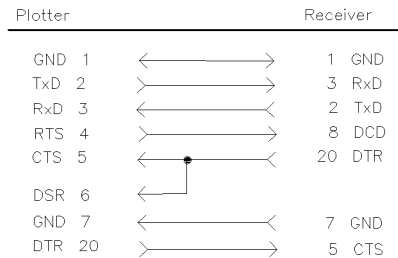

cu113e

Figure B-6. HP-GL Plotter Connection

Switch Settings

Set the switches on the HP-GL plotter to the following settings. Set the baud rate of the plotter and instrument to the same value. After setting the switch positions, turn plotter off, then on again.

Switch Position	Switch Position
Expand: ◀	Parity: ▶ (Off)
Emulate: ◀	Even/Odd: ▶ (Odd)
Stand-alone: ◀	Duplex: ▶ (Full)
Monitor Mode: ▶ (normal)	Hardwire: ◀
Local ▶ (normal)	DTR-Bypass: ▶ (normal)

Setting the Instrument Baud Rate

The baud rates of the instrument and the personal computer must be the same. For example, to set the instrument to 9600 baud, use the following procedure:

1. Press the **CONFIG**, **More 1 of 3**.
2. Press the **BAUD RATE** softkey.
3. Press these keys: 9600, **Hz**. To set the baud rate to 1200 baud, press these keys: 1200, **Hz**.

Note Some of the programs in this manual use 1200 baud for proper operation. If your system uses the RS-232 handshake lines, you can use 9600 baud for all of the programs.

Index

A

A1, 4-9
A2, 4-9
A3, 4-9
A4, 4-9
A-block format, 3-10
ABS, 4-25
absolute value, 4-25
activate marker, 4-235
active function, 4-135
 decreasing value with DN, 4-105
ADD, 4-27
address
 changing the HP-IB address, A-1
 HP-IB operation, A-1
alternate commands, 4-9–10
AMB, 4-29
AMBPL, 4-32
AMPCOR, 4-34
AMPLN, 4-37
amplitude
 marker type, 4-269
amplitude correction, 4-34
amplitude correction length, 4-37
amplitude units, 4-4, 4-43
ANNOT, 4-38
annotation, 4-38
APB, 4-39
ARNG, 4-40
AT, 4-41
attenuation, 4-41
AUNITS, 3-8, 4-43
AUTO, 4-45
auto average, 4-47
AUTOAVG, 4-47
AUTOCAL, 4-48
auto couple, 4-45
automatic calibration, 4-48
AUTOQPD, 4-49
auto range, 4-40
auxiliary interface control line A, 4-81
auxiliary interface control line B, 4-82
auxiliary interface control line C, 4-83
auxiliary interface control line D, 4-84
auxiliary interface control line I, 4-85
AVBW, 4-50

average, 4-52
average detection, 4-87
average noise level at the marker
 MKNOISE, 4-250
average video bandwidth, 4-50
AVG, 4-52
AXB, 4-54

B

B1, 4-9
B2, 4-9
B3, 4-9
B4, 4-9
back space
 label function, 4-150
base band instrument preset, 4-151
BASIC
 INPUT command, 2-5
 REAL command, 2-6
BAUDRATE, 4-55
baud rate of instrument, 4-55
B format, 3-9, 3-10
BIT, 4-57
bit checking, 4-57
BITF, 4-59
bit flag, 4-59
BL, 4-9
BLANK, 4-61
blank trace, 4-61
BML, 4-62
BREAK
 RS-232 operation, B-2
BTC, 4-63
BXC, 4-64
BYPASS, 4-65
bypass path, 4-65

C

C1, 4-9
C2, 4-9
CA, 4-9
CAL, 4-66
CALCHECK, 4-69
calibration, 4-66
calibration check, 4-69
calibration switch, 4-70

- calibration time, 4-71
- CALSW, 4-70
- CALTIME, 4-71
- carriage return
 - label function, 4-150
- CAT, 4-72
- catalog, 4-72
- cataloging internal memory, 4-75
- cataloging the floppy disk, 4-74
- center frequency, 2-4, 4-76
- center frequency step size, 4-396
- CF, 2-4, 4-76
- changing the amplitude units
 - AUNITS, 4-43
- changing the average video bandwidth
 - AVBW, 4-50
- changing the HP-IB address, A-1
- changing the video bandwidth
 - VB, 4-447
- character, 4-3
- character & EOI, 4-3
- characters and secondary keywords, 4-5-8
- clear average, 4-78
- clear status byte, 4-80
- clear to send
 - RS-232 handshaking line, B-1
- clear write, 4-79
- CLRAVG, 4-78
- CLRW, 4-79
- CLS, 4-80
- CNTLA, 4-81
- CNTLB, 4-82
- CNTLC, 4-83
- CNTLD, 4-84
- CNTLI, 4-85
- combining two traces, 4-88
- command mnemonic, 4-2
- commands, 2-2
- command terminators, 4-2
- commenting programming lines, 2-8
- compatible commands, 4-9-10
- COMPRESS, 4-86
- compress trace, 4-86
- CONCAT, 4-88
- concatenate, 4-88
- configuring your computer system, 1-1
- connecting a modem
 - RS-232 operation, B-4
- connecting your instrument to a printer or plotter, 1-13
- connection an HP-GL plotter (RS-232 operation), B-5
- continuous sweep, 4-90
- controlling the marker counter, 4-244
- controlling trace data with a computer, 3-2

- CONTS, 4-90
- convert to absolute units, 4-93
- convert to measurement units, 4-95
- copying the source to a destination
 - MOV, 4-274
- correction factors on, 4-91
- CORREK, 4-91
- COUPLE, 4-92
- CR, 4-9
- creating a trace window, 4-437
- creating a user-defined trace, 4-431
- creating a user-defined variable, 4-443
- CS, 4-9
- CT, 4-9
- CTA, 4-93
- CTM, 4-95
- CTS
 - RS-232 handshaking line, B-1
- current units, 4-4
- CV, 4-9

D

- data byte, 4-3
- data byte & EOI, 4-3
- data carrier detect
 - RS-232 handshaking line, B-2
- data entry
 - disabling, 4-135
- data lines
 - RS-232, B-1
- data terminal ready
 - RS-232 handshaking line, B-2
- date mode, 4-96
- DATEMODE, 4-96
- DCD
 - RS-232 handshaking line, B-2
- delete limit-line table, 4-154
- deleting a file from a floppy disk, 4-309
- deleting softkeys, 4-100
- delimiter, 4-3
- delta
 - marker type, 4-269
- DEMODO, 4-97
- demodulation, 4-97
- DET, 4-98
- detection mode, 4-98
- determining the trace status, 4-435
- digit, 4-3
- displaying a trace, 4-433
- displaying the screen title, 4-425
- displaying the time and date, 4-424
- display line, 4-103
- DISPOSE, 4-100
- DIV, 4-101
- divide, 4-101

DL, 4-103
 DN, 4-105
 DONE, 4-106
 dotted lines, 4-2
 down, 4-105
 DSR
 RS-232 handshaking line, B-2
 DTR
 RS-232 handshaking line, B-2

E

E1, 4-9
 E2, 4-9
 E3, 4-9
 E4, 4-9
 EDITANNOT, 4-108
 edit annotation, 4-108
 EK, 4-109
 EM, 4-9
 enable knob, 4-109
 enable limit-line testing, 4-185
 end-or-identify, 3-6
 END statement, 3-12
 enhancements
 label function, 4-150
 enter limit-line segment for frequency, 4-179
 enter limit-line segment for sweep time,
 4-182
 enter parameter function, 4-110
 EOI, 3-6, 3-12
 EP, 4-110
 ERASE, 4-111
 error messages, 5-1
 errors, non recoverable, 5-12
 EX, 4-9
 exchange, 4-457
 exchange trace A and trace B, 4-54
 exchanging traces
 XCH, 4-458
 excursion
 marker peak excursion, 4-258
 EXITANNOT, 4-112
 exit annotation, 4-112
 EXP, 4-113
 exponent, 4-113
 external preamplifier gain, 4-299
 external trigger mode, 4-426

F

FA, 4-116
 fast Fourier transform, 4-122
 creating a trace window, 4-437
 marker readout, 4-260
 fast marker, 4-118
 FASTMRKR, 4-118
 fatal errors, 5-12
 FB, 4-119
 FCALDATE, 4-121
 FFT, 4-122
 creating a trace window, 4-437
 fft marker readout, 4-260
 finding the absolute value, 4-25
 finding the maximum
 MXM, 4-279
 finding the minimum value, 4-226
 fixed
 marker type, 4-269
 FLATTOP filter
 FFT, 4-123
 FM gain, 4-126
 FMGAIN, 4-126
 FOFFSET, 4-127
 force service request, 4-393
 FORMAT, 4-129
 format disk, 4-129
 form feed
 label function, 4-150
 free trigger mode, 4-426
 frequency
 marker readout, 4-260
 start frequency, 4-117
 frequency-amplitude correction factors
 number of, 4-37
 frequency offset, 4-127
 frequency units, 4-4
 FS, 4-130
 FSER, 4-131
 full span, 4-130
 functional index, 4-1, 4-11*ff*

G

GRAT, 4-132
 graticule, 4-132

H

handshaking connection
 RS-232 operation, B-2
 handshaking lines
 RS-232, B-1
 HANNING filter
 FFT, 4-123
 hardware error messages, 5-1
 harmonic number, 4-136
 harmonic number lock, 4-137
 HAVE, 4-133
 HD, 4-135
 Hewlett-Packard interface bus, A-1
 HN, 4-136
 HNLOCK, 4-137
 HNUNLK, 4-139

- hold data entry, 4-135
- HP 9000 Series 200 technical computers, 1-3
- HP 9000 Series 300 technical computers, 1-5
- HP BASIC
 - CLEAR command, 2-2
 - CREATE command, 3-3
 - DIM command, 3-5
 - END command, 2-3
 - ENTER, 3-6
 - LOCAL command, 2-3
 - REAL command, 2-5
 - USING command, 3-6
- HP-IB interface, 1-1
- HP-IB interface bus, A-1
- HP Vectra personal computer
 - HP-IB interface, 1-7
 - RS-232 interface, 1-9

I

- IB, 4-140
- I-block format, 3-11
- IBM PC/AT and compatible computers, 1-11
- ID, 4-141
- identify, 4-141
- IFBW, 4-142
- impedance
 - INZ, 4-146
- impedance units, 4-4
- increasing the value
 - UP, 4-441
- informational messages, 5-1
- input B, 4-140
- input impedance, 4-146
- instrument command, 4-3
- instrument preset, 2-2, 4-147
- instrument state, 3-5
- INT, 4-144
- integer, 4-144
- integer number range, 4-3
- interface bus
 - RS-232, B-1
- intermediate frequency bandwidth, 4-142
- inverse sweep time
 - marker readout, 4-260
- inverse video
 - label function, 4-150
- INZ, 4-146
- IP, 2-2, 4-147

K

- knob
 - enabling knob with EP, 4-109
- KSA, 4-9
- KSB, 4-9
- KSc, 4-9

- KSC, 4-9
- KSE, 4-9
- KSG, 4-9
- KSH, 4-9
- KSi, 4-9
- KSl, 4-9
- KSm, 4-9
- KSM, 4-9
- KSn, 4-9
- KSo, 4-9
- KSO, 4-9
- KSp, 4-9
- KSZ, 4-9

L

- L0, 4-9
- last calibration date, 4-121
- last key menu, 4-150
- LASTKEYMENU, 4-150
- last span, 4-196
- LF, 3-6, 4-151
- LG, 4-152
- LIMIAMPSCCL, 4-153
- LIMIDEL, 4-154
- LIMIDISP, 4-155
- LIMIFAIL, 4-157
- LIMIFRQSCCL, 4-159
- LIMIFT, 4-160
- LIMIHI, 4-161
- LIMILINE, 4-163
- LIMILINESTA, 4-166
- LIMILO, 4-168
- LIMIMARGAMP, 4-169
- LIMIMARGSTA, 4-170
- LIMIMIRROR, 4-172
- LIMIMODE, 4-174
- LIMINUM, 4-176
- LIMIREL, 4-177
- LIMISEG, 4-179
- LIMISEGT, 4-182
- LIMITEST, 4-185
- limit line
 - entry mode, 4-174
- limit-line amplitude scale, 4-153
- limit line display, 4-155
- limit-line frequency scale, 4-159
- limit-line number, 4-176
- limit lines, 4-163
 - enable limit-line testing, 4-185
 - enter limit-line segment for frequency, 4-179
 - enter limit-line segment for sweep time, 4-182
 - limits failed, 4-157
 - mirror limit line, 4-172

- relative limit lines, 4-177
- limit-line state, 4-166
- limit margin amplitude, 4-169
- limit-margin state, 4-170
- limits failed, 4-157
- LINCHK, 4-187
- linear, 4-188
- linearity check, 4-187
- linear scale, 4-190
- line-feed, 3-6
- line feed
 - label function, 4-150
- line trigger mode, 4-426
- LINFILL, 4-188
- LN, 4-190
- LOAD, 4-191
- loading a file from the disk drive, 4-191
- LOG, 4-193
- logarithm, 4-193
- logarithmic scale, 4-152
- LOGSWEEPSPD, 4-197
- log sweep speed, 4-197
- log to linear conversion, 4-113
- lower limit line, 4-168
- lsb length, 4-3
- LSB length, 3-10
- LSPAN, 4-196

M

- M1, 4-10
- M2, 4-10
- M3, 4-10
- M4, 4-198
- MA, 4-10
- Marker Amplitude, 4-233
- marker as the active function, 4-236
- marker bandwidth, 4-237
- marker continue, 4-239
- marker counter, 4-244
- marker counter resolution, 4-245
- marker delta, 4-240
- marker frequency, 4-242
- marker frequency output, 4-224
- marker minimum, 4-247
- marker noise, 4-250
- marker normal, 4-248
- marker off, 4-252
- marker pause, 4-255
- marker peak, 4-257
- marker peak excursion, 4-258
- marker position, 4-253
- marker readout, 4-260
- marker readout in frequency, 4-260
- marker step size, 4-264
- marker stop, 4-266

- marker to center frequency, 4-238
- marker to reference level, 4-262
- marker to span, 4-263
- marker trace, 4-267
- marker track, 4-268
- marker type, 4-269
 - amplitude, 4-269
 - delta, 4-269
 - fixed, 4-269
 - position, 4-269
- marker zoom, 4-198
- mass storage is, 4-278
- maximum, 4-279
- maximum hold, 4-281
- MC, 4-10
- MDS, 3-9, 4-200
- MDS command
 - MKF programming example, 4-243
- MDU, 4-202
- MEAN, 4-204
- MEANTH, 4-206
- MEASALLSIGS, 4-208
- MEASAVG, 4-209
- MEASFREQ, 4-210
- MEASPEAK, 4-211
- MEASQPD, 4-212
- MEASRESULT, 4-213
- MEASSIG, 4-215
- MEASTIMEAVG, 4-216
- MEASTIMEPK, 4-217
- MEASTIMEQPD, 4-218
- MEASURE, 4-219
 - measure all signals, 4-208
 - measure average, 4-209
 - measure frequency, 4-210
 - measurement data size, 3-9, 4-200
 - measurement data units, 4-202
 - measurement units, 3-12, 4-94
 - range, 3-13
 - measure mode, 4-219
 - measure peak, 4-211
 - measure quasi-peak detector, 4-212
 - measure result, 4-213
 - measure signal, 4-215
 - measure time average, 4-216
 - measure time peak, 4-217
 - measure time quasi-peak detector, 4-218
 - measure with preselector peak, 4-221
- MEASWITHPP, 4-221
- MERGE, 4-222
 - merge two traces, 4-222
- MF, 4-224
- M format, 3-12–14
- MIN, 4-226
- MINH, 4-228

- minimum, 4-226
- minimum hold, 4-228
- minimum position, 4-229
- minimum trace value
 - MKMIN, 4-247
- MINPOS, 4-229
- MIRROR, 4-231
- mirror image, 4-231
- mirror limit line, 4-172
- mixer level, 4-270
- MKA, 3-2, 4-233
- MKACT, 4-235
- MKACTV, 4-236
- MKBW, 4-237
- MKCF, 4-238
- MKCONT, 4-239
- MKD, 4-240
- MKF, 3-2, 4-242
- MKFC, 4-244
- MKFCR, 4-245
- MKMIN, 4-247
- MKN, 4-248
- MKNOISE, 4-250
- MKOFF, 4-252
- MKP, 4-253
- MKPAUSE, 4-255
- MKPK, 4-257
- MKPK HI, 2-4
- MKPX, 4-258
- MKREAD, 4-260
- MKRL, 4-262
- MKSP, 4-263
- MKSS, 4-264
- MKSTOP, 4-266
- MKTRACE, 4-267
- MKTRACK, 4-268
- MKTYPE, 4-269
- ML, 4-270
- MOD, 4-272
- modulo, 4-272
- MOV, 4-274
- move, 4-274
- moving the active marker between traces
 - MKTRACE, 4-267
- MPY, 4-276
- msb length, 4-3
- MSB length, 3-10
- MSI, 4-278
- MT0, 4-10
- MT1, 4-10
- multiply, 4-276
- MXM, 4-279
- MXMH, 4-281

N

- natural exponent, 4-115
- negative detection, 4-87
- non recoverable errors, 5-12
- normal detection, 4-87
- normalization
 - using AMB, 4-30
 - using AMBPL, 4-33
- normalized reference level, 4-282
- NRL, 4-282
- number, 4-3

O

- O1, 4-10
- O2, 4-10
- O3, 4-10
- O4, 4-10
- OA, 4-284
- OL, 4-285
- output active function value, 4-284
- output learn string, 4-285
- output termination, 4-3
- overload, 4-286
- over range for measurement units, 3-13
- OVLN, 4-286

P

- parameter units, 3-8
- party-line bus structure, A-1
- PDA, 4-288
- peak average detection, 4-87
- PEAKS, 4-290
- period
 - marker readout, 4-260
- P format, 3-8
- placing a marker
 - MKP, 4-253
- placing a marker on a signal peak
 - MKPK, 4-257
- PLOT, 4-293
- plotter units, 4-202
- plotting
 - HP-IB interface, 1-14
 - RS-232, 1-16
- position
 - marker type, 4-269
- positive and negative peaks detection, 4-87
- positive detection, 4-87
- power bandwidth, 4-310
- POWERON, 4-295
- power-on state, 4-295
- power up time, 4-312
- PP, 4-296
- PREAMP, 4-297
- PREAMPG, 4-299

- preamplifier, 4-297
- preamplifier gain, 4-299
- predefined function, 4-3
- predefined variable, 4-4
- prefix, 4-300
- PREFX, 4-300
- preselector peak, 4-296
- PRINT, 4-301
- print address, 4-302
- printer type, 4-305
- printing
 - HP-IB interface, 1-13
 - RS-232, 1-15
 - with a ThinkJet Printer (RS-232 only), B-3
- print per page, 4-303
- print resolution, 4-304
- PRNTADRS, 4-302
- PRNTPPG, 4-303
- PRNTRES, 4-304
- PRNTTYPE, 4-305
- probability distribution of amplitude, 4-288
- problems, 1-18
- programming guidelines, 2-8
- protect, 4-307
- PROTECT, 4-307
- protect state, 4-308
- protocol
 - RS-232 protocol, B-2
- PSTATE, 4-308
- PURGE, 4-309
- purge file, 4-309
- PWRBW , 4-310
- PWRUPTIME, 4-312

Q

- QPGAIN, 4-313
- quasi-peak detector, 4-49
- quasi-peak gain, 4-313

R

- R1, 4-10
- R2, 4-10
- R3, 4-10
- R4, 4-10
- range, 4-314
- RANGE, 4-314
- ratio
 - setting the video bandwidth ratio, 4-449
- RB, 4-315
- RC, 4-10
- RCLC, 4-317
- RCLS, 4-318
- RCLT, 4-319
- RCVRRMRKR, 4-321
- reading trace data, 3-2

- real number range, 4-3
- recall colors, 4-317
- recalling with a prefix, 4-300
- recall state, 4-318
- recall trace, 4-319
- receiver marker position, 4-321
- recommended path, 4-2
- records, 3-6
- reference level, 4-331
 - marker to reference level, 4-262
- reference level offset, 4-335
- reference-level position, 4-333
- relative limit lines, 4-177
- remainder
 - finding the remainder with MOD, 4-272
- REMEASSIG, 4-323
- remeasure signal, 4-323
- repeating syntax element, 4-2
- REPEAT UNTIL, 4-324
- report definition, 4-336
- request to send
 - RS-232 handshaking line, B-1
- reserved words, 4-2
- reset reference level, 4-326
- RESETRL, 4-326
- resolution bandwidth, 4-315
- returning or storing trace values, 4-428
- returning the instrument to its former state,
 - 3-7
- returning trace A data to the controller
 - TA, 4-412
- returning trace B data to the controller
 - TA, 4-414
- returning trace data
 - changing the trace data format, 4-416
- REV, 4-327
- revision, 4-327
- RF filter section serial number, 4-131
- RFIN, 4-328
- RFINLK, 4-330
- RF input lock, 4-330
- RF input signal, 4-328
- RL, 4-331
- RLPOS, 4-333
- RMS, 4-334
- ROFFSET, 4-335
- root mean square value, 4-334
- rosenfell algorithm, 4-87
- RPTDEF, 4-336
- RQS, 4-337
- RS-232
 - 3-wire connection, B-3
 - baud rate, B-2
 - connecting a modem, B-4
 - connecting an HP-GL plotter, B-5

- connecting a ThinkJet printer, B-3
- data lines, B-1
- handshaking connection for personal computer, B-2
- handshaking lines, B-1
- protocol, B-2
- setting the baud rate, B-5
- RS-232 interface, 1-1
- RS-232 interface bus, B-1
- RTS
 - RS-232 handshaking line, B-1

S

- S1, 4-10
- S2, 4-10
- sample detection, 4-87
- SAVEC, 4-339
- save colors, 4-339
- SAVES, 4-340
- save state, 4-340
- SAVET, 4-341
- save trace, 4-341
- saving and recalling instrument states, 3-5
- saving trace data, 3-3
- saving with a prefix, 4-300
- scaling factor, 4-115, 4-194
- screen title
 - TITLE, 4-425
- secondary keywords, 4-2
- SEGDEL, 4-343
- segment delete, 4-343
- segment entry for frequency limit lines, 4-345
- segment entry for sweep time limit lines, 4-348
- select frequency or time limit line, 4-160
- selecting a trace window for FFT, 4-437
- SENDER, 4-345
- SENTERT, 4-348
- SER, 4-351
- serial number, 4-351
- service request mask, 4-337
- SETC, 4-352
- set colors, 4-352
- set date, 4-354
- SETDATE, 4-354
- set time, 4-355
- SETTIME, 4-355
- setting the average video bandwidth
 - AVBW, 4-50
- setting the baud rate, B-5
- setting the instrument trigger mode, 4-427
- setting the marker counter resolution, 4-245
- setting the real-time clock, 4-423
- setting the threshold level, 4-421

- setting the time and date, 4-423
- setting the trace operations to preset values, 4-434
- setting the video bandwidth
 - VB, 4-447
- setting the video bandwidth ratio, 4-449
- show set up, 4-356
- SHOWSETUP, 4-356
- SIGADD, 4-357
- SIGDEL, 4-358
- SIGDLTAVIEW, 4-359
- SIGGRAPH, 4-361
- SIGLEN, 4-362
- SIGLIST, 4-363
- SIGMARK, 4-364
- signal add, 4-357
- signal delete, 4-358
- signal delta view, 4-359
- signal graph, 4-361
- signal list, 4-363
- signal list length, 4-362
- signal mark, 4-364
- signal position, 4-365
- signal result, 4-366
- signal sort, 4-367
- SIGNAL TRACK
 - MKTRACK, 4-268
- signal unmark, 4-369
- SIGPOS, 4-365
- SIGRESULT, 4-366
- SIGSORT, 4-367
- SIGUNMARK, 4-369
- single sweep, 4-372
- single-sweep mode, 2-3
- SMOOTH, 4-370
- smooth trace, 4-370
- SNGLS, 2-3, 4-372
- source attenuator, 4-381
- source leveling control, 4-380
- source power, 4-388
- source power-level step size, 4-384
- source power offset, 4-383
- source power sweep, 4-386
- source tracking, 4-390
- source tracking peak, 4-392
- SP, 2-4, 4-373
- span, 2-4, 4-373
 - marker to span, 4-263
- span zoom, 4-376
- SPEAKER, 4-375
- special numbers and characters, 4-2
- specifying the frequency of the marker
 - MKF, 4-242
- SPZOOM, 4-376
- SQLCH, 4-377

SQR, 4-378
 square root, 4-378
 squelch, 4-377
 SRCALC, 4-380
 SRCAT, 4-381
 SRCPOFS, 4-383
 SRCPSTP, 4-384
 SRCPSWP, 4-386
 SRCPWR, 4-388
 SRCTK, 4-390
 SRCTKPK, 4-392
 SRQ, 4-393
 SS, 4-396
 ST, 4-398
 standard baud rates, 4-56
 start frequency, 4-116
 status bits
 clearing, 4-80
 status byte query, 4-400
 status of a trace
 TRSTAT, 4-435
 STB, 4-400
 step size
 decreasing by the step size with DN, 4-105
 marker step size, 4-264
 stop frequency, 4-119
 STOR, 4-401
 store, 4-401
 SUB, 4-404
 subtract, 4-404
 SUM, 4-406
 sum of squared trace amplitudes, 4-408
 sum of trace amplitudes, 4-406
 SUMSQR, 4-408
 SV, 4-10
 Sweep Couple, 4-410
 sweep time, 4-398
 marker readout, 4-260
 SWPCPL, 4-410
 syntax elements, 4-2, 4-3-4

T

T0, 4-10
 T1, 4-10
 T2, 4-10
 T3, 4-10
 T4, 4-10
 T7, 4-10
 T8, 4-10
 TA, 4-412
 table definition, 4-415
 take sweep, 4-436
 taking a measurement sweep, 4-436
 TB, 4-414
 TBLDEF, 4-415
 TDF, 3-8, 4-416
 TDF command
 MKF programming example, 4-243
 test program, 1-2
 TH, 4-421
 ThinkJet Printer mode switch settings, B-4
 ThinkJet RS-232 switch settings, B-4
 threshold, 4-421
 time and date
 displaying the time and date, 4-424
 time date, 4-423
 TIMEDATE, 4-423
 time display, 4-424
 TIMEDSP, 4-424
 time units, 4-4
 TITLE, 4-425
 TM, 4-426
 TRA, 3-2, 4-428
 trace A minus trace B, 4-29
 trace A minus trace B plus display line, 4-32
 trace A plus trace B, 4-39
 trace B exchange trace C, 4-64
 trace B minus display line, 4-62
 trace data format, 4-416
 binary, 3-5
 TDF, 2-7
 trace data formats, 3-8
 trace data input and output, 4-428
 trace data transfers, 3-8
 trace define, 4-431
 trace display, 4-433
 trace element, 4-4
 trace math, 3-12
 trace mean, 4-204
 trace mean above threshold, 4-206
 trace memory, 4-430
 trace preset, 4-434
 trace range, 4-4
 trace registers
 determining the total number of trace
 registers available, 4-430
 trace status, 4-435
 trace window, 4-437
 tracking the signal
 MKTRACK, 4-268
 transducer conversion units, 4-459
 transfer A, 4-412
 transfer B, 4-414
 transferring trace A data, 4-412
 transferring trace B data, 4-414
 transfer trace B to trace C, 4-63
 TRA/TRB/TRC, 4-428
 TRB, 4-428
 TRC, 4-428
 TRCMEM, 4-430

TRDEF, 4-431
TRDSP, 4-433
triggering the instrument, 4-427
trigger mode, 4-426
TRPRST, 4-434
TRSTAT, 4-435
TS, 2-3, 4-436
turning off markers
 MKOFF, 4-252
TWNDO, 4-437
two's complement, 4-39
type of marker
 changing the type, 4-269

U

UDKDEFINE, 4-438
UDKSET, 4-439
underlining
 label function, 4-150
UNIFORM filter
 FFT, 4-123
units, 4-4
unlock harmonic number, 4-139
unrange, 4-440
UNRANGE, 4-440
UNTIL, 4-324
UP, 4-441
upper limit line, 4-161
user-created error messages, 5-1
user-defined function, 4-4
user-defined key, 4-438
user-defined key set, 4-439
user-defined trace, 4-4
user-defined variable, 4-4, 4-442

V

VARDEF, 4-442
variable definition, 4-442
variables, 2-5
VARIANCE, 4-444
variance of trace amplitudes, 4-444
VAVG, 4-446
VB, 4-447
VBR, 4-449

vertical tab
 label function, 4-150
video average, 4-446
video bandwidth, 4-447
video bandwidth ratio, 4-449
video trigger mode, 4-426
VIEW, 4-450
viewing a trace
 VIEW, 4-450

W

WAIT, 4-451
window next, 4-452
window off, 4-453
window on, 4-454
windows commands
 WINNEXT, 4-452
 WINOFF, 4-453
 WINON, 4-454
 WINZOOM, 4-456
 ZMKCNTR, 4-460
 ZMKPKNL, 4-462
 ZMKPKNR, 4-463
 ZMKSPAN, 4-464
window zoom, 4-456
WINNEXT, 4-452
WINOFF, 4-453
WINON, 4-454
WINZOOM, 4-456
writing your first program, 2-2

X

XCH, 4-457
XUNITS, 4-459

Z

ZMKCNTR, 4-460
ZMKPKNL, 4-462
ZMKPKNR, 4-463
ZMKSPAN, 4-464
zone marker at center frequency, 4-460
zone marker for next left peak, 4-462
zone marker for next right peak, 4-463
zone marker span, 4-464